



COTSWOLD  
TRANSPORT  
PLANNING

Statkraft UK Ltd

Sheepwash Solar Energy Farm

**Construction Traffic Management  
Plan**

August 2022





---

## DOCUMENT REGISTER

<b>CLIENT:</b>	<b>STATKRAFT UK LTD</b>
<b>PROJECT:</b>	<b>SHEEPWASH SOLAR ENERGY FARM</b>
<b>PROJECT CODE:</b>	<b>21-0354</b>

<b>REPORT TITLE:</b>	<b>CONSTRUCTION TRAFFIC MANAGEMENT PLAN</b>		
<b>PREPARED BY:</b>	<b>KEVIN SYKES</b>	<b>DATE:</b>	<b>AUGUST 2022</b>
<b>CHECKED BY:</b>	<b>CHRIS ELLIOTT</b>	<b>DATE:</b>	<b>AUGUST 2022</b>

<b>REPORT STATUS:</b>	<b>V5 FINAL ISSUE</b>
-----------------------	-----------------------

Prepared by **COTSWOLD** TRANSPORT PLANNING LTD

Bedford i-Lab  
Stannard Way  
Priory Business Park  
Bedford  
MK44 3RZ

**Tel:** 01234 836098

**Email:** [bedford@cotswoldtp.co.uk](mailto:bedford@cotswoldtp.co.uk)

**Web:** [www.cotswoldtp.co.uk](http://www.cotswoldtp.co.uk)



## List of Contents

### Sections

1	Introduction .....	1
2	Site Composition / Location & Local Highway Network.....	3
3	Site Access .....	6
4	Traffic Routing.....	11
5	Vehicle Trip Generation.....	12
6	Highway Condition Surveys.....	17

### Appendices

APPENDIX A: Site Layout Plan
APPENDIX B: Traffic Survey Data
APPENDIX C: Proposed Access Arrangements
APPENDIX D: Swept Path Analysis
APPENDIX E: Site Compound Layout
APPENDIX F: Junction Visibility Splays
APPENDIX G: Construction Traffic Routing

---



# 1 Introduction

## Brief

- 1.1 Cotswold Transport Planning Ltd (CTP) has been instructed by Statkraft UK Ltd to prepare a Construction Traffic Management Plan (CTMP) in support of a planning application for a Solar Energy Farm at land north of Sheephurst Lane, Marden, Kent.
- 1.2 Planning permission is sought for the development of a 50MW Solar Energy Farm with ancillary electrical infrastructure, including 15MW of battery storage. Further details of the proposal and the technology used together with the proposed site layout are included within the supporting documents, submitted separately with the planning application.
- 1.3 A proposed site layout plan is provided in **Appendix A** of this report.
- 1.4 This CTMP has been prepared to address transportation matters associated with the proposed development and has been produced following a detailed site visit. This report also includes additional and amended information following a highways consultation response received from Kent County Council (KCC), as local highway authority, following submission of a planning application (ref: 22/501335/FULL) to Maidstone Borough Council (MBC).
- 1.5 A Public Right of Way Mitigation Strategy has also been prepared by CTP under separate cover to support this scheme

## Scope of Report

- 1.6 This CTMP comprises the following:-
  - i) Review of site location / composition and local highway network;
  - ii) Review of the site access arrangements (for construction and operational phases);
  - iii) The proposed construction vehicle routing;
  - iv) Likely vehicle sizes and vehicle frequencies; and
  - v) The procedure for highway condition surveys.

## Additional Information

- 1.7 It will be the responsibility of the appointed contractor to comply with all statutory regulations as appropriate, in relation to construction and movement activities.



- 1.8 The appointed contractor will be provided with a copy of this CTMP and will adhere to it as part of the planning consent. This report will form part of the on-site induction and a copy will also be made available within the contractor's compound.
- 1.9 The contact details of the contractor and those of the relevant highway officers at Kent County Council will be exchanged before commencement of construction of the Solar Energy Farm.



## 2 Site Composition / Location & Local Highway Network

### Site Composition / Location

- 2.1 The site currently comprises a parcel of agricultural land which has an approximate area of 74.5 hectares.
- 2.2 The site is located north of Sheephurst Lane and east of the B2162 Collier Street. The South Eastern Main Line extends in an east-west direction to the north of the site. Agricultural / undeveloped green fields border the site at all sides.
- 2.3 Access to the site is currently via two gated agricultural accesses from Sheephurst Lane, which are located either side of semi-detached dwellings at the southern end of the site. Access is also achievable at the end of Burtons Lane at the northern end of the site where the Public Right of Way 0330/KM248/2 extends to the east along the northern boundary of the site.
- 2.4 The site location is identified in **Figure 2.1** below.

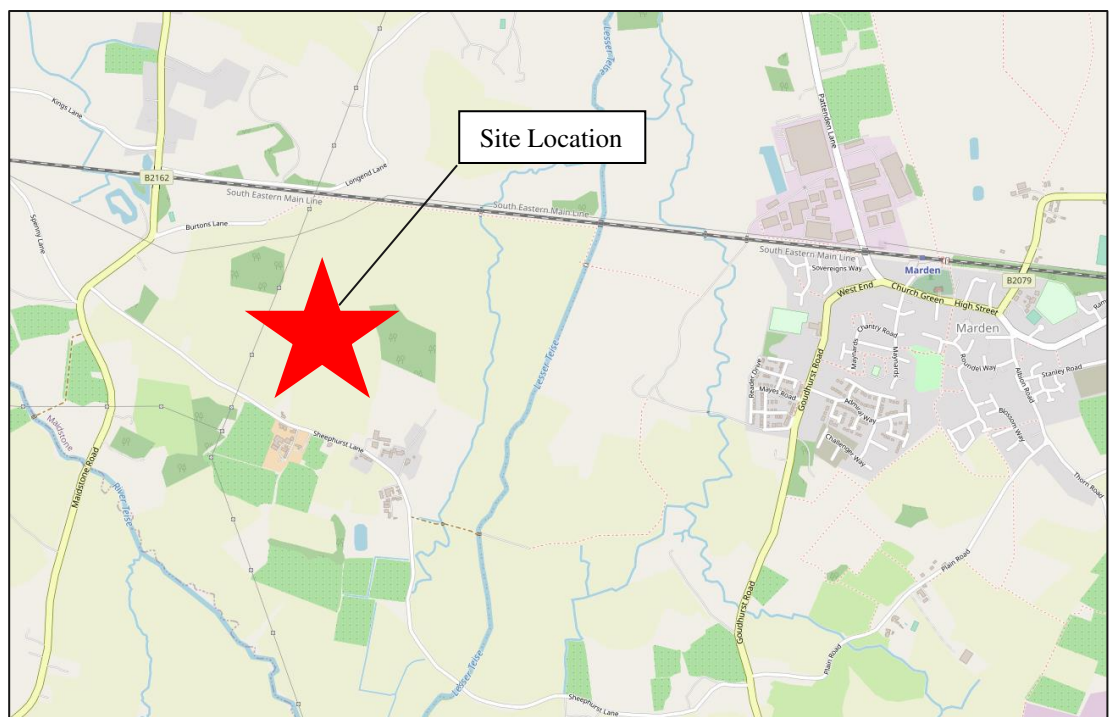

**Figure 2.1: Site Location (source: openstreetmap.org)**



## Local Highway Network

### *Sheephurst Lane*

- 2.5 Sheephurst Lane is a single carriageway road with one lane in each direction, which extends along the southern boundary of the application site from its junction with the B2162 Collier Street in the northwest until its junction with the B2079 West End Goudhurst Road.
- 2.6 Sheephurst Lane is subject to a 50mph speed limit for a length of approximately 750m from its junction with the B2162 Collier Street to the east whereafter it reduces to a 40mph speed limit for the remainder of its length. There are no footways along the length of the carriageway and the road is unlit.
- 2.7 A narrow bridge approximately 3.0m in width is located along Sheephurst Lane approximately 1.1km west of its junction with the B2079 West End Goudhurst Road. Informal passing places are located either side of the bridge to accommodate the passing of two vehicles along this length of the carriageway.
- 2.8 A weight restriction (except for access) is applicable along Sheephurst Lane for vehicles over 7.5 tonnes. This is demarcated by relevant signage when entering Sheephurst Lane from the eastern end via the B2079 West End Goudhurst Road.

### *Collier Street (B2162)*

- 2.9 Collier Street is also a single carriageway road with one lane in each direction as it passes to the west of the proposed Solar Energy Farm. It is subject to a 50mph speed limit and is unlit. There are no footways along Collier Street adjacent to the site.
- 2.10 The B2162 extends in a south-north direction from the village of Lamberhurst just south of the B2162 / A21 junction up until the village of Yalding in the north.
- 2.11 A 7.5 tonne weight restriction (except for access) is applicable along Collier Street from a position just south of its junction with Sheephurst Lane to the north.

### *Burttons Lane*

- 2.12 Burttons Lane is an adopted road maintainable at public expense that serves in the region of 10 residential dwellings. It is a narrow surfaced lane with no street lighting and meets Collier Street at a Y-junction.



2.13 Burtons Lane borders the proposed Solar Energy Farm to the north and extends as PRow 0330/KM248/2 at its eastern end towards the east. There are no footways at either edge of Burtons Lane.

*West End Goudhurst Road (B2079)*

2.14 West End Goudhurst Road is a single carriageway road with one lane in each direction that extends in a south-north direction to the east of the proposed Solar Energy Farm. It is subject to a 50mph speed limit and is unlit in the vicinity of the site. There are no footways along this length of the carriageway.

2.15 The B2079 extends from its junction with the A21 in the south up until the A229 in the north, passing through the village of Marden.

*A229*

2.16 The A229 extends in a south-north direction, extending from its junction with the A21 in the south up until Chatham in the north, passing through Maidstone and provides links to the wider Strategic Road Network (SRN) i.e. the M20 and M2 north of Maidstone.

2.17 The A229 is a single carriageway road with one lane in each direction where the B2079 meets it at a Y-junction. The A229 is subject to a 60mph speed limit along this length and is unlit.





## 3 Site Access

### Introduction

- 3.1 The site layout plan, which is provided at **Appendix A**, shows that the primary access to the Solar Energy Farm will be from Sheephurst Lane to the west of the existing semi-detached cottages.
- 3.2 The Point of Connection (POC), which will be located at the northwestern corner of the Solar Energy Farm will be accessed via a secondary access from Burtons Lane.

### Construction Access

#### *Sheephurst Lane*

- 3.3 The site layout plan indicates that the site compound will be positioned approximately 150m north of the two existing semi-detached dwellings known as Little Sheephurst Cottages, which are located on the northern side of Sheephurst Lane.
  - 3.4 In order to provide access to this site compound and the larger site for construction purposes, a new vehicular access is proposed approximately 200m west of the cottages.
  - 3.5 The access will take the form of a priority T-junction with Sheephurst Lane and will be formed by a 6m wide access road with 10m junction radii to accommodate the turning of large construction vehicles.
  - 3.6 The first 25m of the access road will be hard surfaced to prevent any loose material from the site being hauled onto the public highway. The site access road will reduce to 4m in width approximately 50m into the site.
  - 3.7 In order to determine visibility splays required at the Sheephurst Lane access, 24-hour, 7-day speed surveys were undertaken along the carriageway either side of the proposed access location for the period 22 July 2021 to 28 July 2021.
  - 3.8 The results of the speed surveys indicate 85<sup>th</sup> percentile recorded speeds along Sheephurst Lane of 44.5mph and 45.9mph on approach from the west and east respectively. This means that when interpolated from the Design Manual for Roads and Bridges (DMRB), visibility splays of 138m and 143.6m are required to the west and east of the access respectively.
  - 3.9 A full copy of the speed survey data is available at **Appendix B**.
-



- 3.10 CTP drawing **21-0354 SK01 rev A**, which is provided at **Appendix C**, shows the extent of the site access and associated visibility splays. This drawing demonstrates that the visibility splays are able to be accommodated within the adopted highway and land under the control of the applicant. It is acknowledged that there will be some hedge removal and vegetation trimming required to the west of the site access to accommodate the visibility splay in this direction.
- 3.11 A swept path analysis of the proposed access arrangements along Sheephurst Lane have been undertaken to demonstrate that a 16.5m articulated HGV can be accommodated by the proposed primary site access. This is shown at CTP drawing **21-0354 SP01 rev B**, which is provided at **Appendix D**.
- 3.12 It should be noted that the 132kV transformer will be transported to site on a 30m long lorry and trailer. As this is a one off trip to the site for the delivery of the equipment, this will be subject to discussions with the local highway authority as it is likely to require temporary short term road closures at specific locations to accommodate the large vehicle. It is likely that the transformer will be delivered to the Solar Energy Farm via the main access from Sheephurst Lane.
- Burtons Lane*
- 3.13 No access is required from Burtons Lane for construction vehicles.
- Construction / Contractor Practices*
- 3.14 Banksmen will be provided at the site construction access. They will not direct general traffic but will indicate to heavy and large construction vehicles when it is appropriate for them to access and egress the site. Priority will always be provided to the existing traffic using the adjacent highway network.
- 3.15 A temporary access track will be laid on the surface of the site access route and any overrun areas as appropriate to provide ground protection and to enable it to support the loading of HGVs and plant. This is likely to be in the form of a rolled gravel track which will be bound with screenings (fine, powder sized stone material) to reduce the propensity of debris being taken on to the adjacent highway. Alternatively, metal sheets might be used.
- 3.16 A temporary construction compound is proposed at the southern end of the site approximately 300m from the Sheephurst Lane access where the largest vehicles associated with the construction phase will be able to turn. Deliveries will include
-



containers, batteries, transformers and cranes, amongst others and the swept path analysis drawings demonstrate that this will be accessible for large HGVs.

- 3.17 All construction vehicles will therefore enter and exit the site in forward gear. The details of the construction compound are included on the site layout drawing which is included at **Appendix E**.
- 3.18 The internal site access road will include wheel washing facilities during the construction phase. Given the temporary, short term nature of the construction phase, wheel wash facilities will be provided in the form of a portable automated high pressure wheel washer with motion sensors to conserve water. This will reduce the spread of debris onto the local highway network.
- 3.19 All construction vehicles will therefore have to exit through the wheel wash area prior to accessing the local highway network. Furthermore, a mobile road sweeper can be deployed by the applicant should the highway authority consider this is necessary.

### Operational Access

- 3.20 Access for maintenance vehicles, usually in the form of 4 x 4's, serving the operational Solar Energy Farm will typically be via Sheephurst Lane. The construction access from Sheephurst Lane will be retained as the primary operational access, however, a secondary point of access from Burtons Lane will also allow maintenance vehicles access to the POC at the northwestern end of the Solar Energy Farm.
- 3.21 It is proposed that the end of Burtons Lane is extended by approximately 10m to meet the access road that will serve the POC. The access road will be 4m in width and hard surfaced for the first 25m to prevent any loose material from the site being hauled onto Burtons Lane.
- 3.22 In order to ensure that the Collier Street / Burton Lane is considered a safe and suitable means of access to accommodate additional vehicle movements, an assessment of the visibility splays at the junction have been undertaken.
- 3.23 Speed surveys were conducted along Collier Street north and south of its junction with Burtons Lane over a 24-hour, 7-day period from 22 July 2021 to 28 July 2021. The results of the speed surveys indicate 85<sup>th</sup> percentile recorded speeds along Collier Street of 37.0mph and 45.7mph on approach from the north and south respectively. This means that when interpolated from the Design Manual for Roads and Bridges



(DMRB), visibility splays of 90m and 142.8m are required to the north and south of the junction respectively.

- 3.24 A full copy of the speed survey data is provided at **Appendix B**.
- 3.25 CTP drawing **21-0354 SK02**, which is provided at **Appendix F**, shows the extent of the visibility splays at the Collier Street / Burtons Lane junction. This drawing demonstrates that visibility splays commensurate with recorded 85<sup>th</sup> percentile speeds are able to be accommodated within the adopted highway.

### Public Rights of Way

- 3.26 A Public Right of Way (PROW) known as footpath KM248/2 extends from the eastern end of Burtons Lane along the northern edge of the site boundary. Approximately 430m west of the northeastern corner of the site, footpath KM248/2 extends in a south easterly direction across the site until it meets the eastern site boundary approximately 140m south of the most northeastern corner.
- 3.27 At this point, footpath KM248/2 extends to the east as footpath KM248/3 to join a wider network of PROWs. **Figure 3.1** shows the PROWs in the vicinity of the proposed Solar Energy Farm.

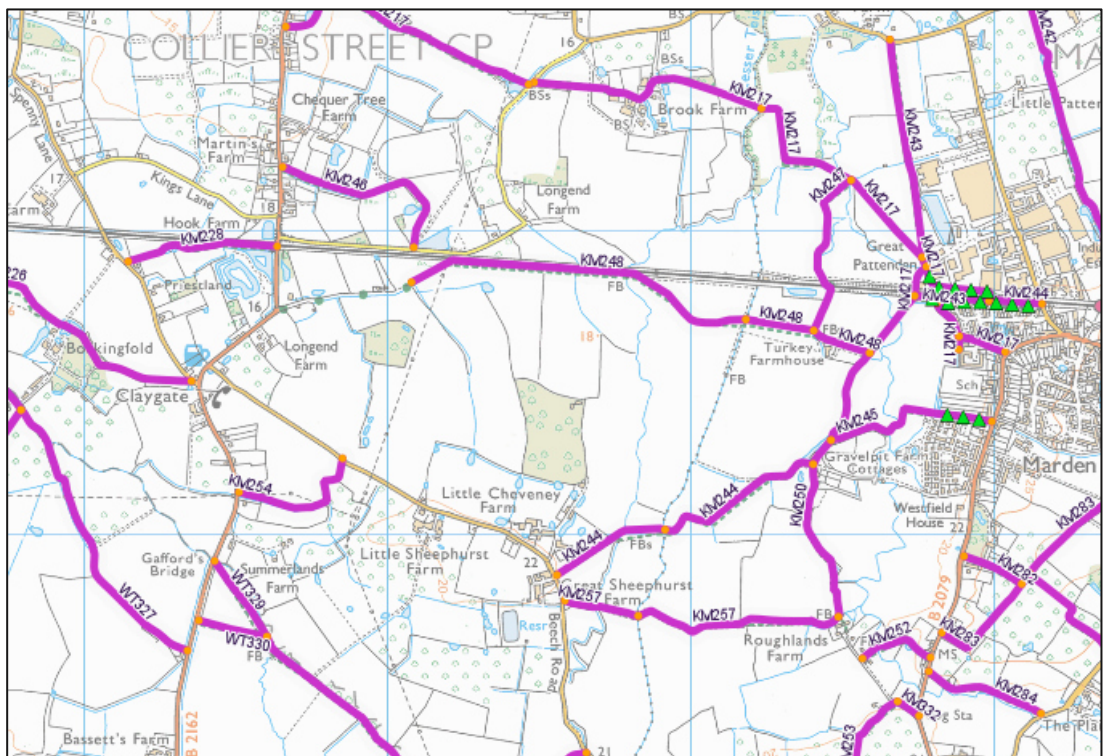

**Figure 3.1: PROW network extract (source: KCC PROW Map)**



- 3.28 As part of the development of the site, it is proposed to divert public footpath KM248/2 at the northeastern corner of the site to accommodate the Solar Energy Farm.
- 3.29 In addition, two new permissive footpaths are proposed to the west and east of the site. The western path extends from Sheephurst Lane in the south to Burtons Lane in the north. The eastern path extends from KM248 on the northeastern boundary of the site to Sheephurst Lane. **Figure 3.2** shows the proposed diversion of footpath KM248/2 and location of the new permissive footpaths.

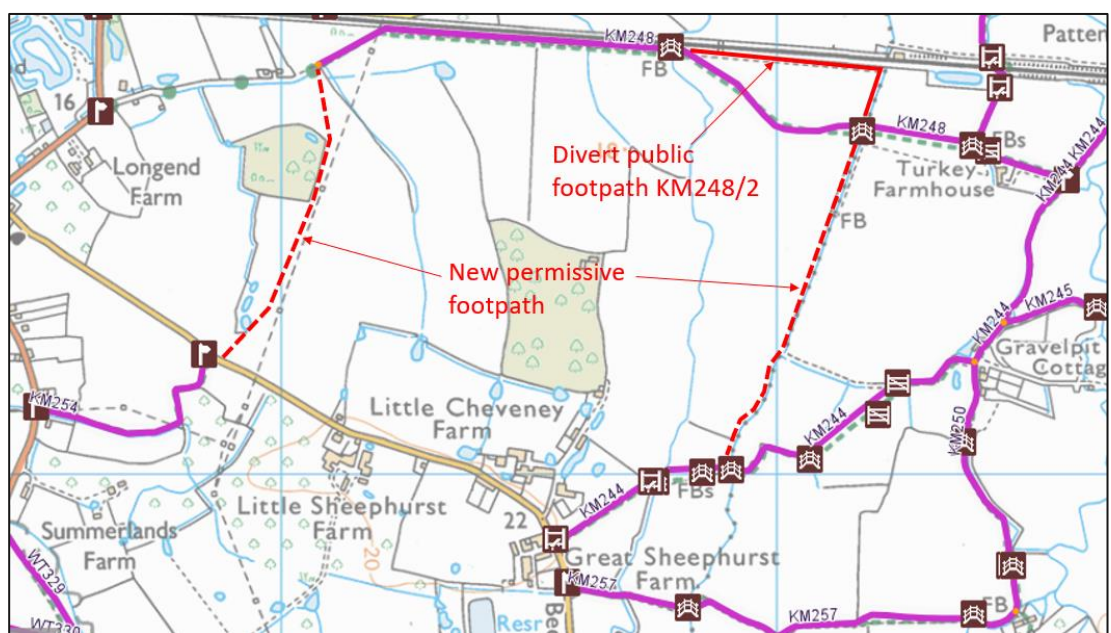

**Figure 3.2: Proposed amendments to PROW network**

- 3.30 A Public Rights of Way Management Strategy is included at **Appendix E**. Any vehicles associated with the construction phase will be required to stop and give way to any users of the public footpath at any time. Consideration may also be given to temporary diversions of the footpath as appropriate.

### Summary

- 3.31 It is considered that the temporary construction and permanent operational site access arrangements are suitable to accommodate the quantum and type of vehicles associated with the construction and ongoing operation / maintenance of the proposed Solar Energy Farm. This is supported by the swept path analysis assessments detailed in this section, which ensure safe and suitable access is achievable without resulting in a potential detrimental impact on the local highway network.





## 4 Traffic Routing

- 4.1 When considering the routing of construction traffic to the site, KCC have suggested a preferred route as part of their highways consultation response to the planning application.
- 4.2 It was previously suggested that the routing agreed as part of the recently constructed Solar Farm at Widehurst Farm, Thorn Road, Marden (ref: 15/505971/FULL) be utilised. It is now proposed to still utilise the northern section of this route, however, the southern section is amended to incorporate KCC's comments.
- 4.3 The proposed route is now for construction traffic to access the application site from the north from the A229 then via B2079 Maidstone Road. Where construction traffic would have turned left to serve the Widehurst Farm site they would now turn right and access Sheephurst Lane and the site access from the B2079 West End Goudhurst Road.
- 4.4 CTP drawing **21-0354 SP02 rev A**, which is provided at **Appendix D**, shows the swept path of a 16.5m articulated lorry through the B2079 West End Goudhurst Road / Sheephurst Lane junction.
- 4.5 The designated route for all traffic associated with the construction of the Solar Energy Farm is illustrated at **Appendix G**.
- 4.6 In relation to the transit of specific large materials associated with the Solar Energy Farm, the PV panels and frames will be shipped in 40ft shipping containers which are typically carried to the site on a 16.5m-18m long articulated vehicle.
- 4.7 There will be some delivery vehicles of extended length, including a 30m long lorry and trailer that will deliver the 132kV transformer. As detailed in **Section 3**, this is the longest vehicle which will be associated with the construction phase of the Solar Energy Farm and will be subject to specific road closures to accommodate access to the site.



## 5 Vehicle Trip Generation

### Construction Phase

- 5.1 The applicant has confirmed that the construction of the Solar Energy Farm is expected to take approximately 24 weeks. Construction at the site will be carried out Monday to Friday 08:00 to 18:00, and Saturdays 08:00 to 13:30. No construction or deliveries will take place on Sundays or Bank Holidays.
- 5.2 The construction phase includes the preparation of the site, installing the temporary access permeable crushed stone for access roads, erection of security fencing and CCTV, assembly and erection of the PV arrays, installation of the inverters and grid connection and installation of the battery modules.
- 5.3 A maximum of up to 80-100 construction workers are anticipated to be on site during peak times during the construction period. A temporary construction compound area will be provided, as illustrated in **Appendix E**.
- 5.4 The location where staff will travel from is unknown at this stage as it will depend on the appointed contractor. However, it is envisaged that a number of the non-local workforce will stay at local accommodation and be transported to the site by minibuses to minimise the impact on the strategic and local highway network.
- 5.5 Parking will be provided within the compound for construction contractors and as such no overspill car parking will occur on the local highway network. The site compound is able to accommodate 37 car parking spaces, which is considered appropriate especially when a number of local staff will be transported by minibus or car share. The location of the car parking spaces is shown on the site compound drawing provided at **Appendix E**.
- 5.6 The construction period will include the use of HGVs to bring the equipment onto the site and this will be strictly managed to ensure that vehicle movement is controlled and kept to a minimum.
- 5.7 The components which are required to construct the Solar Energy Farm will predominantly arrive in standardised 40ft intermodal (shipping) containers by 16.5-18m long articulated vehicles, however, there will also be vehicles of extended length including a 30m long lorry and trailer that will deliver the 132kV transformer, as detailed in **Section 4**.
-



- 5.8 The applicant, from their experience of implementing commercial scale solar farms elsewhere, has indicated that the vehicular movements presented in **Table 5.1** and **Table 5.2** are likely to be associated with the construction phase.
- 5.9 Some deliveries will be associated with the preparation of the access tracks within the
- 5.10 site. Permeable crushed aggregate will be used to construct the access tracks on the site and to the compounds. The aggregate is likely to arrive on 10m long tipper trucks.
- 5.11 Permeable crushed aggregate will also be used to provide the base for the construction compound and temporary parking area for construction workers.
- 5.12 The site will be enclosed by security fencing with two gated vehicular access points. A total of 4,500m of fencing is required to secure the Solar Energy Farm with wooden support posts proposed approximately every three metres. The fencing will be delivered by 10m hiab lorries.
- 5.13 The site compound will comprise containers for storage, a canteen, toilets and a drying room, which will be delivered by a 16.5m-18m articulated vehicles.
- 5.14 In summary, the following heavy goods movements could be associated with the construction period for the Solar Energy Farm as set out in **Table 5.1**.

Activity	Vehicle Size	Number of Deliveries (movements)
Site compound facilities and temporary fencing	10m Hiab Lorry	25 (50 two-way movements)
Temporary Access Track	10m Hiab Lorry	75 (150 two-way movements)
Aggregate for Access Track	10m Tipper Truck	450 (900 two-way movements)
Modules	18m Articulated Lorry with 40ft container on trailer	210 (420 two-way movements)
Inverters	16.5m Articulated Lorry with curtain side trailer	20 (40 two-way movements)
Piles	16.5m Articulated Lorry with curtain side trailer	50 (100 two-way movements)
Framework	16.5m Articulated Lorry with curtain side trailer	90 (180 two-way movements)





Cable	16.5m Articulated Lorry with curtain side trailer	74 (148 two-way movements)
Field array substation transformers	16.5m Articulated Lorry with 20ft container on trailer	18 (36 two-way movements)
Aggregate for field array substations	10m Tipper Truck 16.5m Articulated Lorry	90 (180 two-way movements)
Crane for lifting/positioning substations	16m Mobile Crane	18 (36 two-way movements)
Fencing	10m Hiab Lorry	80 (160 two-way movements)
Other construction plant and materials	Various 10m low/side Loaders and Hiabs	65 (130 two-way movements)
Site skips	10m Rigid Truck	125 (250 two-way movements)
Fuel, water, small materials	Large Van	80 (160 two-way movements)
Staff on-site	Minibus for mechanical installer and private vehicles for installers	4 x minibus, 2x large van + 20 private vehicles (on a <b>daily</b> basis)
<b>Total</b>		<b>1,470 deliveries</b> (average of 13 deliveries per day or 26 two-way movements per day)*
* Deliveries taking place over a 24 week period (120 working days, excluding Saturdays to be robust)		

**Table 5.1: Anticipated HGV movements during construction of Solar Energy Farm.**

5.15 In addition, the following heavy goods movements could be associated with the construction of the Battery Energy Storage element of the development as set out in **Table 5.2.**

Activity	Vehicle Size	Number of Deliveries (movements)
Battery Storage Containers	16.5m Articulated lorry with 20ft container on trailer	4 (8 two-way movements)



Crane for lifting/positioning battery containers	16m Mobile Crane	4 (8 two-way movements)
Inverters	16.5m Articulated Lorry with curtain side trailer	4 (8 two-way movements)
Other battery equipment (transformers, PCS, etc.)	16.5m Articulated Lorry with curtain side trailer	8 (16 two-way movements)
132/33kV Transformer	30m Lorry and Trailer	1 (2 two-way movements)
HV switchgear and metering	10m Hiab Lorry 16.5m Articulated Lorry	15 (30 two-way movements)
DNO/substation buildings	16.5m Articulated Lorry	4 (8 two-way movements)
Cable	16.5m Articulated Lorry with curtain side trailer	15 (30 two-way movements)
Aggregate for HV + battery compound	10m Tipper Truck 16.5m Articulated Lorry	40 (80 two-way movements)
Aggregate for the access track	10m Tipper Truck 16.5m Articulated Lorry	45 (90 two-way movements)
Palisade fencing	10m Hiab Lorry	20 (40 two-way movements)
<b>Total</b>		<b>160 deliveries</b> (average of 2 deliveries per day or 4 two two-way movements per day)*
* Deliveries taking place over a 24 week period (120 working days, excluding Saturdays to be robust)		

**Table 5.2: Anticipated HGV movements during construction of Battery Energy Storage.**

### Operational Phase

- 5.16 Once operational, there are anticipated to be around 10 to 20 visits to the site a year for equipment maintenance. These would typically be made by light van or 4 x 4 type vehicles.
- 5.17 Whilst the temporary construction compound will have been removed, space will remain within the site on the access tracks for such a vehicle to turn around to ensure that the vehicle can enter and exit the site in forward gear.



### Summary

- 5.18 Based on the above, it is expected that there will be an average of around 15 large vehicles per day accessing the site over the construction phase.
- 5.19 There will also be construction workers arriving at the site first thing in the morning and departing in the evening, although the numbers involved are forecast to be relatively low on a day-to-day basis.
- 5.20 The level of traffic during the temporary construction phase is not considered to result in a material impact on the safety or operation of the local highway network.



## 6 Highway Condition Surveys

- 6.1 A walk-over condition survey on the local highway network will be carried out and agreed with highway officers, prior to commencement of construction, in order to assess the baseline highway condition. This will be in the form of a photographic record and location plan.
- 6.2 This would be followed by a further condition survey with highway officers including a photographic record covering the same extents as the pre-construction condition survey at the end of construction activities, in order to ensure any highway defects attributable to the construction of the Solar Energy Farm (if any) are identified and any necessary remedial works are agreed.

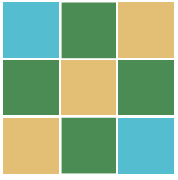

COTSWOLD  
TRANSPORT  
PLANNING

## Appendix A

Site Layout Plan



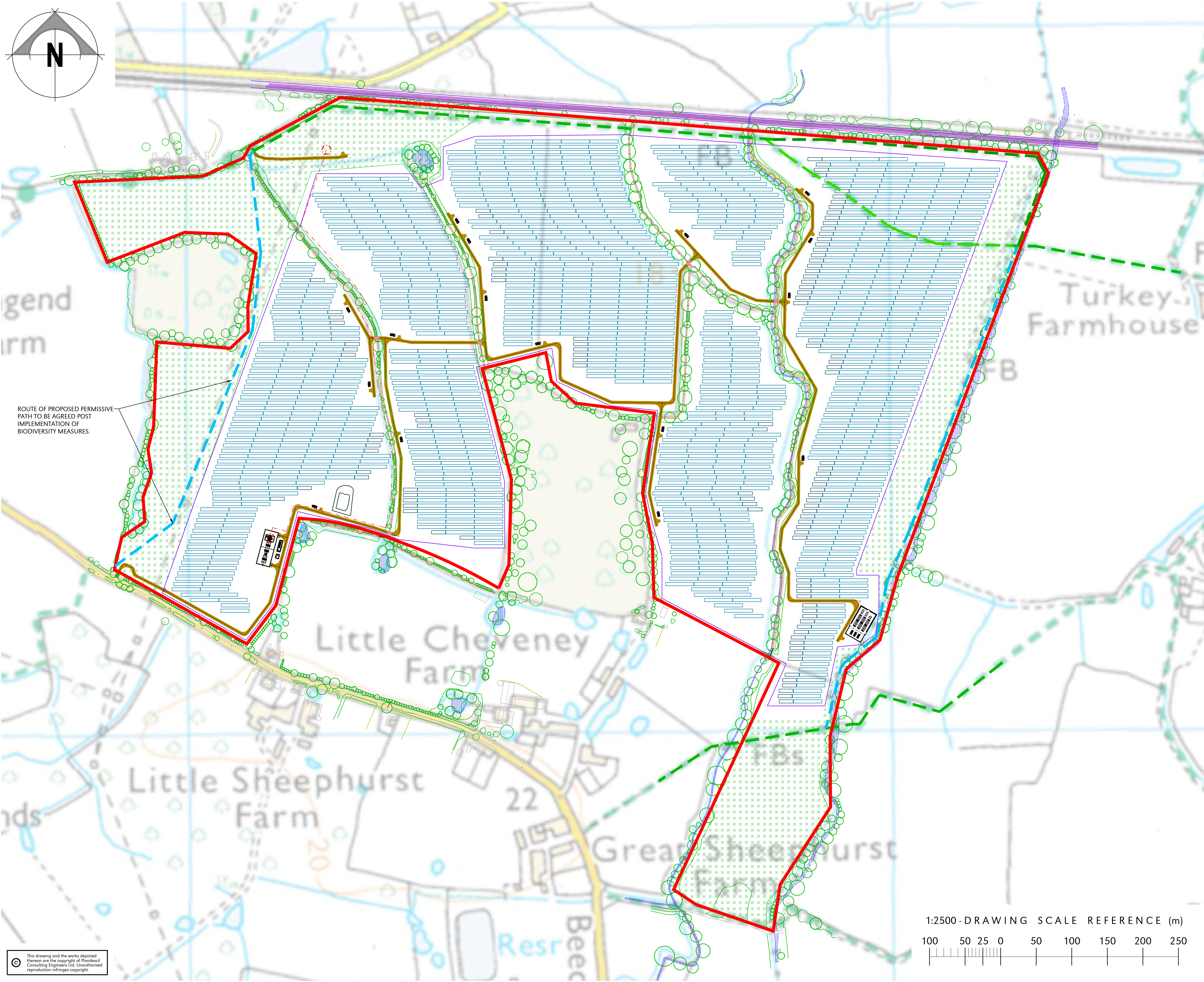
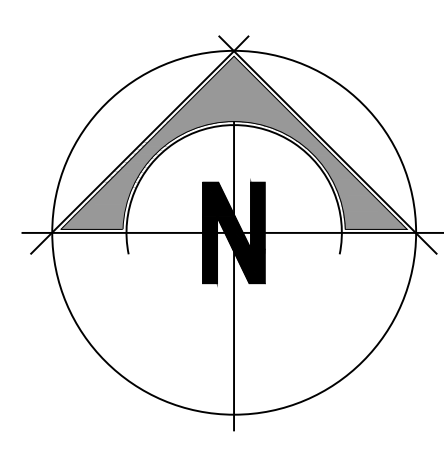

ROUTE OF PROPOSED PERMISSIVE PATH TO BE AGREED POST IMPLEMENTATION OF BIODIVERSITY MEASURES.

- GENERAL NOTES:**
1. All dimensions noted are in millimetres unless stated otherwise.
  2. All levels to be above Ordnance Survey Datum defined levels (A.O.Dm) unless noted otherwise.
  3. Do not scale from this drawing, if dimensions are not clear ask.
  4. This document has been created in accordance with Plandescil Ltd. Terms & Conditions along with the scope of works provided by the client to Plandescil Ltd. Any use of this document other than for its original purpose is prohibited, Plandescil Ltd. accept no liability for any third party uses of this document.
  5. Plandescil Ltd. to be immediately notified of any suspected omissions or discrepancies.
  6. This drawing is to be read in conjunction with the following Plandescil drawings
    - 27899 - 051 Rev 0 - Proposed Solar Farm Aerial Site Location Plan
    - 27899 - 052 Rev 0 - Proposed Solar Farm Framework Plan and System Summary
    - 27899 - 053 Rev 0 - Proposed Solar Farm Footpath & Boundary Layout
  7. All setting out to be coordinated by the Contractor and to be checked onsite prior to construction.

**LEGEND**

	Railway
	Existing Roads
	Connection Route
	Perimeter Fence (4,500 m)
	Boundary
	Public Footpath (Existing)
	Public Footpath Removed (Proposed)
	Public Footpath Relocation (Proposed)
	Permissive Footpath (Proposed)
	Biodiversity Area (8.78 ha)
	Maintenance Track
	Ditch Crossing
	Ditch
	Water
	Trees
	Power Station (x16)
	Battery Energy Storage System
	HV Compound
	PV Structure 2P30
	PV Structure 2P15
	Existing Properties

**PROPOSAL ONLY**  
**NOT CDM 2015 COMPLIANT**

Note: Proposed site plan and information from Statkraft, no survey or design work undertaken by Plandescil Ltd.  
 Drawing adapted from Statkraft drawing SCUJK-MARDN-000 100 (G)

**ISSUED FOR CLIENT REVIEW**

Rev	Date	Rev By	Chkd	Description
B	08-02-22	DAD	AF	Amendments to Boundary & Footpath
A	01-02-22	DAD	AF	Minor Amendments
0	18-01-22	-	AF	First Issue

**plandescil**  
 consulting engineers

Connaught Road Attleborough Norfolk NR17 2BW  
 Telephone: (01953) 452001 Fax: (01953) 456955  
 Email: pdc@plandescil.co.uk www.plandescil.co.uk

civil / structural / environmental / surveying

Client  
**Origin Power Servcies Ltd**

Project  
**Proposed Solar Farm,  
 Land North of Sheephurst Lane,  
 Marden, Tonbridge**

Drawing Title  
**Proposed Solar Farm  
 Site Layout**

Scale	U.N.O.	Date	Drawn By
1:2500 (A1)		January 2022	DAD
Drawing No.	27899/050	Rev	B

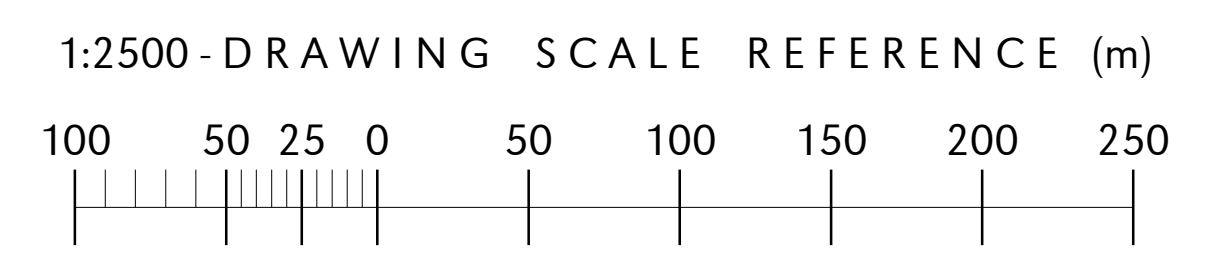

This drawing and the works depicted thereon are the copyright of Plandescil Consulting Engineers Ltd. Unauthorised reproduction infringes copyright.



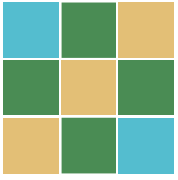

COTSWOLD  
TRANSPORT  
PLANNING

## Appendix B

Traffic Survey Data

# K&M TRAFFIC SURVEYS

SITE: SHEEPHURST LN EAST

LOCATION: ATTACHED TO TELEGRAPH POLE

GRID REFERENCE: 51.170604, 0.459739

DIRECTION: WESTBOUND

SPEED LIMIT: 50

22 July 2021

Time	Total	Vbin 6 12	Vbin 12 19	Vbin 19 25	Vbin 25 31	Vbin 31 37	Vbin 37 43	Vbin 43 50	Vbin 50 56	Vbin 56 62	Vbin 62 68	Vbin 68 75	Vbin 75 81	Vbin 81 87	Vbin 87 93	Vbin 93 99	Mean	Vpp 85
0000	4	0	0	0	1	0	2	1	0	0	0	0	0	0	0	0	39.4	-
0100	0	0	0	0	0	0	0	0	0	0	0	0	0	0	0	0	-	-
0200	2	0	0	0	0	0	2	0	0	0	0	0	0	0	0	0	42.2	-
0300	2	0	0	0	0	1	0	1	0	0	0	0	0	0	0	0	39.5	-
0400	4	0	0	0	1	2	1	0	0	0	0	0	0	0	0	0	36.3	-
0500	8	0	0	0	4	2	1	0	1	0	0	0	0	0	0	0	33.8	-
0600	34	0	1	0	2	6	16	7	2	0	0	0	0	0	0	0	39.8	46.3
0700	48	0	2	3	0	13	19	10	1	0	0	0	0	0	0	0	38	45
0800	60	0	1	0	6	16	23	14	0	0	0	0	0	0	0	0	38.6	45.1
0900	60	0	0	1	2	22	24	8	2	1	0	0	0	0	0	0	38.7	45.2
1000	62	0	2	1	2	26	23	8	0	0	0	0	0	0	0	0	36.6	42.7
1100	56	0	1	2	6	20	19	7	1	0	0	0	0	0	0	0	36.5	43.1
1200	45	1	3	0	3	14	18	6	0	0	0	0	0	0	0	0	36.4	43.3
1300	54	0	0	0	2	27	20	4	1	0	0	0	0	0	0	0	37.3	41.8
1400	47	0	2	1	4	14	20	6	0	0	0	0	0	0	0	0	37.1	43.3
1500	62	0	1	0	2	22	23	11	3	0	0	0	0	0	0	0	39.1	46.1
1600	65	0	0	2	3	23	28	8	1	0	0	0	0	0	0	0	38	43.2
1700	69	0	0	1	7	16	29	14	2	0	0	0	0	0	0	0	39.3	46.2
1800	56	0	1	4	4	15	18	10	4	0	0	0	0	0	0	0	37.9	44.7
1900	42	0	2	8	4	11	13	4	0	0	0	0	0	0	0	0	33.1	42.5
2000	32	0	0	0	5	9	15	2	1	0	0	0	0	0	0	0	37.3	42.7
2100	20	0	0	0	2	11	6	1	0	0	0	0	0	0	0	0	35.5	40.3
2200	6	0	0	1	0	2	3	0	0	0	0	0	0	0	0	0	35.4	-
2300	3	0	0	0	0	1	1	0	1	0	0	0	0	0	0	0	43.5	-
<b>07-19</b>	<b>684</b>	<b>1</b>	<b>13</b>	<b>15</b>	<b>41</b>	<b>228</b>	<b>264</b>	<b>106</b>	<b>15</b>	<b>1</b>	<b>0</b>	<b>0</b>	<b>0</b>	<b>0</b>	<b>0</b>	<b>0</b>	<b>37.9</b>	<b>44</b>
<b>06-22</b>	<b>812</b>	<b>1</b>	<b>16</b>	<b>23</b>	<b>54</b>	<b>265</b>	<b>314</b>	<b>120</b>	<b>18</b>	<b>1</b>	<b>0</b>	<b>0</b>	<b>0</b>	<b>0</b>	<b>0</b>	<b>0</b>	<b>37.6</b>	<b>44</b>
<b>06-00</b>	<b>821</b>	<b>1</b>	<b>16</b>	<b>24</b>	<b>54</b>	<b>268</b>	<b>318</b>	<b>120</b>	<b>19</b>	<b>1</b>	<b>0</b>	<b>0</b>	<b>0</b>	<b>0</b>	<b>0</b>	<b>0</b>	<b>37.6</b>	<b>43.9</b>
<b>00-00</b>	<b>841</b>	<b>1</b>	<b>16</b>	<b>24</b>	<b>60</b>	<b>273</b>	<b>324</b>	<b>122</b>	<b>20</b>	<b>1</b>	<b>0</b>	<b>0</b>	<b>0</b>	<b>0</b>	<b>0</b>	<b>0</b>	<b>37.6</b>	<b>43.9</b>



23 July 2021

Time	Total	Vbin 6 12	Vbin 12 19	Vbin 19 25	Vbin 25 31	Vbin 31 37	Vbin 37 43	Vbin 43 50	Vbin 50 56	Vbin 56 62	Vbin 62 68	Vbin 68 75	Vbin 75 81	Vbin 81 87	Vbin 87 93	Vbin 93 99	Mean	Vpp 85
0000	2	0	0	0	0	1	1	0	0	0	0	0	0	0	0	0	37.4	-
0100	0	0	0	0	0	0	0	0	0	0	0	0	0	0	0	0	-	-
0200	5	0	0	0	1	1	2	1	0	0	0	0	0	0	0	0	38.4	-
0300	1	0	0	0	0	1	0	0	0	0	0	0	0	0	0	0	34.2	-
0400	1	0	0	0	0	0	0	1	0	0	0	0	0	0	0	0	43.8	-
0500	8	0	0	0	0	3	4	0	0	1	0	0	0	0	0	0	39.8	-
0600	16	0	0	0	1	5	6	4	0	0	0	0	0	0	0	0	39.4	44.3
0700	42	0	2	0	3	10	15	10	1	1	0	0	0	0	0	0	39.4	45.1
0800	60	0	0	3	1	15	25	14	1	1	0	0	0	0	0	0	40	46.5
0900	45	0	0	0	3	14	18	8	2	0	0	0	0	0	0	0	38.9	45.6
1000	51	0	0	3	8	16	17	5	2	0	0	0	0	0	0	0	36.4	43.7
1100	50	0	1	6	4	17	18	3	1	0	0	0	0	0	0	0	35.3	42
1200	42	0	5	0	2	10	19	5	1	0	0	0	0	0	0	0	36.9	43.5
1300	37	0	0	0	3	14	15	5	0	0	0	0	0	0	0	0	37.8	43.5
1400	40	1	0	0	3	20	11	3	2	0	0	0	0	0	0	0	36.6	42
1500	40	0	0	2	3	19	9	3	4	0	0	0	0	0	0	0	37.6	45.4
1600	39	0	0	2	1	19	12	3	2	0	0	0	0	0	0	0	37.1	43
1700	29	0	1	1	2	8	9	5	3	0	0	0	0	0	0	0	38.8	45.7
1800	43	0	1	0	2	12	20	7	1	0	0	0	0	0	0	0	38.3	44.1
1900	17	0	0	0	2	5	6	2	1	1	0	0	0	0	0	0	39.9	48.6
2000	17	1	1	2	3	2	6	1	1	0	0	0	0	0	0	0	32.7	42.3
2100	7	0	0	1	1	1	3	0	1	0	0	0	0	0	0	0	37.2	-
2200	10	0	0	0	0	5	5	0	0	0	0	0	0	0	0	0	37.1	-
2300	6	0	0	0	1	2	2	1	0	0	0	0	0	0	0	0	37.1	-
<b>07-19</b>	<b>518</b>	<b>1</b>	<b>10</b>	<b>17</b>	<b>35</b>	<b>174</b>	<b>188</b>	<b>71</b>	<b>20</b>	<b>2</b>	<b>0</b>	<b>0</b>	<b>0</b>	<b>0</b>	<b>0</b>	<b>0</b>	<b>37.8</b>	<b>44.2</b>
<b>06-22</b>	<b>575</b>	<b>2</b>	<b>11</b>	<b>20</b>	<b>42</b>	<b>187</b>	<b>209</b>	<b>78</b>	<b>23</b>	<b>3</b>	<b>0</b>	<b>0</b>	<b>0</b>	<b>0</b>	<b>0</b>	<b>0</b>	<b>37.7</b>	<b>44.2</b>
<b>06-00</b>	<b>591</b>	<b>2</b>	<b>11</b>	<b>20</b>	<b>43</b>	<b>194</b>	<b>216</b>	<b>79</b>	<b>23</b>	<b>3</b>	<b>0</b>	<b>0</b>	<b>0</b>	<b>0</b>	<b>0</b>	<b>0</b>	<b>37.7</b>	<b>44.2</b>
<b>00-00</b>	<b>608</b>	<b>2</b>	<b>11</b>	<b>20</b>	<b>44</b>	<b>200</b>	<b>223</b>	<b>81</b>	<b>23</b>	<b>4</b>	<b>0</b>	<b>0</b>	<b>0</b>	<b>0</b>	<b>0</b>	<b>0</b>	<b>37.7</b>	<b>44.2</b>

24 July 2021

Time	Total	Vbin 6 12	Vbin 12 19	Vbin 19 25	Vbin 25 31	Vbin 31 37	Vbin 37 43	Vbin 43 50	Vbin 50 56	Vbin 56 62	Vbin 62 68	Vbin 68 75	Vbin 75 81	Vbin 81 87	Vbin 87 93	Vbin 93 99	Mean	Vpp 85
0000	2	0	0	0	1	0	1	0	0	0	0	0	0	0	0	0	33.8	-
0100	3	0	1	0	0	2	0	0	0	0	0	0	0	0	0	0	28.8	-
0200	1	0	0	0	0	0	1	0	0	0	0	0	0	0	0	0	42.1	-
0300	1	0	0	0	0	0	1	0	0	0	0	0	0	0	0	0	39	-
0400	2	0	0	0	1	1	0	0	0	0	0	0	0	0	0	0	32	-
0500	3	0	0	0	0	1	2	0	0	0	0	0	0	0	0	0	38.2	-
0600	9	0	0	0	1	1	5	2	0	0	0	0	0	0	0	0	38.5	-
0700	10	0	0	0	0	1	7	2	0	0	0	0	0	0	0	0	40.1	-
0800	16	0	0	0	2	5	6	3	0	0	0	0	0	0	0	0	38.3	44.1
0900	26	0	1	0	0	8	12	4	1	0	0	0	0	0	0	0	40	47.6
1000	25	0	0	0	3	4	14	4	0	0	0	0	0	0	0	0	38.5	44.6
1100	30	0	3	1	1	8	12	4	0	1	0	0	0	0	0	0	37.2	44.8
1200	25	0	0	0	3	9	9	3	1	0	0	0	0	0	0	0	37.7	44.3
1300	42	0	2	2	4	17	12	4	1	0	0	0	0	0	0	0	35.6	42.6
1400	23	0	1	1	2	8	5	5	1	0	0	0	0	0	0	0	37.6	48.2
1500	26	0	4	2	3	4	5	6	2	0	0	0	0	0	0	0	35	45.2
1600	29	0	3	0	0	13	7	5	1	0	0	0	0	0	0	0	36	46.2
1700	17	0	0	1	0	8	5	2	0	1	0	0	0	0	0	0	37.5	45
1800	17	0	0	0	0	5	9	3	0	0	0	0	0	0	0	0	39.3	43.8
1900	9	0	1	0	0	2	1	5	0	0	0	0	0	0	0	0	38.9	-
2000	7	0	0	0	1	2	2	2	0	0	0	0	0	0	0	0	39.1	-
2100	5	0	0	0	2	1	1	1	0	0	0	0	0	0	0	0	36.1	-
2200	4	0	1	0	1	1	1	0	0	0	0	0	0	0	0	0	30.6	-
2300	6	0	0	0	1	2	3	0	0	0	0	0	0	0	0	0	36.9	-
<b>07-19</b>	<b>286</b>	<b>0</b>	<b>14</b>	<b>7</b>	<b>18</b>	<b>90</b>	<b>103</b>	<b>45</b>	<b>7</b>	<b>2</b>	<b>0</b>	<b>0</b>	<b>0</b>	<b>0</b>	<b>0</b>	<b>0</b>	<b>37.4</b>	<b>44.5</b>
<b>06-22</b>	<b>316</b>	<b>0</b>	<b>15</b>	<b>7</b>	<b>22</b>	<b>96</b>	<b>112</b>	<b>55</b>	<b>7</b>	<b>2</b>	<b>0</b>	<b>0</b>	<b>0</b>	<b>0</b>	<b>0</b>	<b>0</b>	<b>37.5</b>	<b>44.8</b>
<b>06-00</b>	<b>326</b>	<b>0</b>	<b>16</b>	<b>7</b>	<b>24</b>	<b>99</b>	<b>116</b>	<b>55</b>	<b>7</b>	<b>2</b>	<b>0</b>	<b>0</b>	<b>0</b>	<b>0</b>	<b>0</b>	<b>0</b>	<b>37.4</b>	<b>44.7</b>
<b>00-00</b>	<b>338</b>	<b>0</b>	<b>17</b>	<b>7</b>	<b>26</b>	<b>103</b>	<b>121</b>	<b>55</b>	<b>7</b>	<b>2</b>	<b>0</b>	<b>0</b>	<b>0</b>	<b>0</b>	<b>0</b>	<b>0</b>	<b>37.3</b>	<b>44.5</b>

25 July 2021

Time	Total	Vbin 6 12	Vbin 12 19	Vbin 19 25	Vbin 25 31	Vbin 31 37	Vbin 37 43	Vbin 43 50	Vbin 50 56	Vbin 56 62	Vbin 62 68	Vbin 68 75	Vbin 75 81	Vbin 81 87	Vbin 87 93	Vbin 93 99	Mean	Vpp 85
0000	2	0	0	0	0	2	0	0	0	0	0	0	0	0	0	0	36.2	-
0100	3	0	0	0	0	0	1	2	0	0	0	0	0	0	0	0	43.7	-
0200	0	0	0	0	0	0	0	0	0	0	0	0	0	0	0	0	-	-
0300	0	0	0	0	0	0	0	0	0	0	0	0	0	0	0	0	-	-
0400	0	0	0	0	0	0	0	0	0	0	0	0	0	0	0	0	-	-
0500	2	0	0	0	1	0	1	0	0	0	0	0	0	0	0	0	34.9	-
0600	4	0	0	0	0	1	1	0	1	1	0	0	0	0	0	0	47	-
0700	11	0	0	0	0	2	5	2	1	1	0	0	0	0	0	0	43.2	51.2
0800	20	0	0	1	2	4	8	5	0	0	0	0	0	0	0	0	38.7	46.6
0900	23	0	2	1	0	5	8	6	1	0	0	0	0	0	0	0	38.2	46.4
1000	37	1	4	3	3	7	14	4	1	0	0	0	0	0	0	0	34.3	43.3
1100	32	0	3	4	2	13	7	2	1	0	0	0	0	0	0	0	33.5	41.3
1200	49	0	1	0	1	20	18	7	1	1	0	0	0	0	0	0	38.8	44.3
1300	27	0	0	0	0	9	10	7	1	0	0	0	0	0	0	0	40	46.5
1400	32	0	0	0	5	15	6	4	2	0	0	0	0	0	0	0	37.6	44.2
1500	22	0	1	0	4	6	7	4	0	0	0	0	0	0	0	0	36.5	44.6
1600	32	0	0	1	3	9	14	5	0	0	0	0	0	0	0	0	37.9	44
1700	33	0	0	0	0	15	11	6	1	0	0	0	0	0	0	0	39.4	45.5
1800	16	0	0	1	2	4	8	1	0	0	0	0	0	0	0	0	36.1	42
1900	6	0	0	0	1	3	0	1	1	0	0	0	0	0	0	0	38.6	-
2000	14	0	0	1	0	6	5	1	1	0	0	0	0	0	0	0	37.5	45.1
2100	11	0	0	0	1	5	4	1	0	0	0	0	0	0	0	0	37.2	43.8
2200	4	0	0	0	1	1	2	0	0	0	0	0	0	0	0	0	34.9	-
2300	3	0	0	0	0	0	2	1	0	0	0	0	0	0	0	0	42.4	-
<b>07-19</b>	<b>334</b>	<b>1</b>	<b>11</b>	<b>11</b>	<b>22</b>	<b>109</b>	<b>116</b>	<b>53</b>	<b>9</b>	<b>2</b>	<b>0</b>	<b>0</b>	<b>0</b>	<b>0</b>	<b>0</b>	<b>0</b>	<b>37.6</b>	<b>44.6</b>
<b>06-22</b>	<b>369</b>	<b>1</b>	<b>11</b>	<b>12</b>	<b>24</b>	<b>124</b>	<b>126</b>	<b>56</b>	<b>12</b>	<b>3</b>	<b>0</b>	<b>0</b>	<b>0</b>	<b>0</b>	<b>0</b>	<b>0</b>	<b>37.7</b>	<b>44.7</b>
<b>06-00</b>	<b>376</b>	<b>1</b>	<b>11</b>	<b>12</b>	<b>25</b>	<b>125</b>	<b>130</b>	<b>57</b>	<b>12</b>	<b>3</b>	<b>0</b>	<b>0</b>	<b>0</b>	<b>0</b>	<b>0</b>	<b>0</b>	<b>37.7</b>	<b>44.7</b>
<b>00-00</b>	<b>383</b>	<b>1</b>	<b>11</b>	<b>12</b>	<b>26</b>	<b>127</b>	<b>132</b>	<b>59</b>	<b>12</b>	<b>3</b>	<b>0</b>	<b>0</b>	<b>0</b>	<b>0</b>	<b>0</b>	<b>0</b>	<b>37.7</b>	<b>44.7</b>

26 July 2021

Time	Total	Vbin 6 12	Vbin 12 19	Vbin 19 25	Vbin 25 31	Vbin 31 37	Vbin 37 43	Vbin 43 50	Vbin 50 56	Vbin 56 62	Vbin 62 68	Vbin 68 75	Vbin 75 81	Vbin 81 87	Vbin 87 93	Vbin 93 99	Mean	Vpp 85
0000	1	0	0	0	0	0	0	1	0	0	0	0	0	0	0	0	46.3	-
0100	0	0	0	0	0	0	0	0	0	0	0	0	0	0	0	0	-	-
0200	1	0	0	0	0	1	0	0	0	0	0	0	0	0	0	0	31.6	-
0300	1	0	0	0	0	0	1	0	0	0	0	0	0	0	0	0	41.1	-
0400	4	0	0	0	1	2	1	0	0	0	0	0	0	0	0	0	33.3	-
0500	8	0	0	0	0	2	3	2	1	0	0	0	0	0	0	0	42.3	-
0600	16	0	0	0	1	2	8	4	1	0	0	0	0	0	0	0	41.2	46.8
0700	43	0	1	0	1	9	21	7	4	0	0	0	0	0	0	0	40.6	46.9
0800	25	0	0	0	2	5	13	5	0	0	0	0	0	0	0	0	39.7	44.3
0900	32	0	0	0	4	12	11	4	1	0	0	0	0	0	0	0	37.6	44
1000	33	0	1	2	2	12	14	2	0	0	0	0	0	0	0	0	36.1	41.6
1100	40	0	3	0	4	13	13	7	0	0	0	0	0	0	0	0	36.6	45.4
1200	43	0	2	1	2	14	17	7	0	0	0	0	0	0	0	0	37.1	44.4
1300	29	0	1	1	3	8	11	3	2	0	0	0	0	0	0	0	37.4	47.4
1400	22	0	0	0	5	12	5	0	0	0	0	0	0	0	0	0	34.6	41.7
1500	35	0	0	2	2	16	12	3	0	0	0	0	0	0	0	0	36.6	42.6
1600	45	0	2	2	4	15	17	4	1	0	0	0	0	0	0	0	36	43
1700	26	0	0	3	2	6	9	5	1	0	0	0	0	0	0	0	37.8	46.4
1800	27	0	0	0	2	9	10	4	2	0	0	0	0	0	0	0	39.2	45.8
1900	23	1	0	3	1	3	9	5	1	0	0	0	0	0	0	0	36.6	45.4
2000	17	1	1	0	0	5	7	3	0	0	0	0	0	0	0	0	37.2	46.6
2100	6	0	0	0	1	1	2	2	0	0	0	0	0	0	0	0	39.2	-
2200	4	0	0	0	0	0	1	2	1	0	0	0	0	0	0	0	45.8	-
2300	0	0	0	0	0	0	0	0	0	0	0	0	0	0	0	0	-	-
<b>07-19</b>	<b>400</b>	<b>0</b>	<b>10</b>	<b>11</b>	<b>33</b>	<b>131</b>	<b>153</b>	<b>51</b>	<b>11</b>	<b>0</b>	<b>0</b>	<b>0</b>	<b>0</b>	<b>0</b>	<b>0</b>	<b>0</b>	<b>37.4</b>	<b>43.8</b>
<b>06-22</b>	<b>462</b>	<b>2</b>	<b>11</b>	<b>14</b>	<b>36</b>	<b>142</b>	<b>179</b>	<b>65</b>	<b>13</b>	<b>0</b>	<b>0</b>	<b>0</b>	<b>0</b>	<b>0</b>	<b>0</b>	<b>0</b>	<b>37.5</b>	<b>44</b>
<b>06-00</b>	<b>466</b>	<b>2</b>	<b>11</b>	<b>14</b>	<b>36</b>	<b>142</b>	<b>180</b>	<b>67</b>	<b>14</b>	<b>0</b>	<b>0</b>	<b>0</b>	<b>0</b>	<b>0</b>	<b>0</b>	<b>0</b>	<b>37.6</b>	<b>44.1</b>
<b>00-00</b>	<b>481</b>	<b>2</b>	<b>11</b>	<b>14</b>	<b>37</b>	<b>147</b>	<b>185</b>	<b>70</b>	<b>15</b>	<b>0</b>	<b>0</b>	<b>0</b>	<b>0</b>	<b>0</b>	<b>0</b>	<b>0</b>	<b>37.7</b>	<b>44.3</b>

27 July 2021

Time	Total	Vbin 6 12	Vbin 12 19	Vbin 19 25	Vbin 25 31	Vbin 31 37	Vbin 37 43	Vbin 43 50	Vbin 50 56	Vbin 56 62	Vbin 62 68	Vbin 68 75	Vbin 75 81	Vbin 81 87	Vbin 87 93	Vbin 93 99	Mean	Vpp 85
0000	2	0	0	0	1	0	1	0	0	0	0	0	0	0	0	0	32.4	-
0100	0	0	0	0	0	0	0	0	0	0	0	0	0	0	0	0	-	-
0200	1	0	0	0	0	0	1	0	0	0	0	0	0	0	0	0	41.1	-
0300	0	0	0	0	0	0	0	0	0	0	0	0	0	0	0	0	-	-
0400	0	0	0	0	0	0	0	0	0	0	0	0	0	0	0	0	-	-
0500	7	0	0	0	1	0	5	1	0	0	0	0	0	0	0	0	40	-
0600	17	0	0	1	0	4	7	4	1	0	0	0	0	0	0	0	40.2	47.3
0700	45	0	0	0	1	11	17	11	4	1	0	0	0	0	0	0	41.8	49
0800	39	0	1	2	1	12	19	4	0	0	0	0	0	0	0	0	37.3	42.7
0900	23	0	0	0	2	7	9	4	1	0	0	0	0	0	0	0	38.6	44.5
1000	42	0	2	0	5	14	13	7	1	0	0	0	0	0	0	0	37.2	44.2
1100	31	0	1	0	1	7	13	8	0	1	0	0	0	0	0	0	39.6	44.2
1200	35	0	0	0	4	18	9	3	1	0	0	0	0	0	0	0	36.8	41.6
1300	29	0	2	4	2	11	8	1	1	0	0	0	0	0	0	0	34.4	42.3
1400	23	0	0	1	4	6	8	4	0	0	0	0	0	0	0	0	36.7	45
1500	32	0	1	0	1	10	7	10	3	0	0	0	0	0	0	0	40.2	47.1
1600	33	0	0	1	0	8	14	8	2	0	0	0	0	0	0	0	40.3	47.1
1700	47	0	3	0	1	15	15	10	3	0	0	0	0	0	0	0	38.9	46.3
1800	26	0	0	0	3	9	6	6	2	0	0	0	0	0	0	0	39.5	46.9
1900	12	0	0	0	0	6	5	0	1	0	0	0	0	0	0	0	37.7	43.5
2000	7	0	0	0	0	2	2	2	1	0	0	0	0	0	0	0	42.5	-
2100	7	0	0	0	1	3	3	0	0	0	0	0	0	0	0	0	36.6	-
2200	2	0	0	0	0	1	0	1	0	0	0	0	0	0	0	0	37.9	-
2300	2	0	0	0	0	2	0	0	0	0	0	0	0	0	0	0	34.9	-
<b>07-19</b>	<b>405</b>	<b>0</b>	<b>10</b>	<b>8</b>	<b>25</b>	<b>128</b>	<b>138</b>	<b>76</b>	<b>18</b>	<b>2</b>	<b>0</b>	<b>0</b>	<b>0</b>	<b>0</b>	<b>0</b>	<b>0</b>	<b>38.6</b>	<b>45.3</b>
<b>06-22</b>	<b>448</b>	<b>0</b>	<b>10</b>	<b>9</b>	<b>26</b>	<b>143</b>	<b>155</b>	<b>82</b>	<b>21</b>	<b>2</b>	<b>0</b>	<b>0</b>	<b>0</b>	<b>0</b>	<b>0</b>	<b>0</b>	<b>38.6</b>	<b>45.3</b>
<b>06-00</b>	<b>452</b>	<b>0</b>	<b>10</b>	<b>9</b>	<b>26</b>	<b>146</b>	<b>155</b>	<b>83</b>	<b>21</b>	<b>2</b>	<b>0</b>	<b>0</b>	<b>0</b>	<b>0</b>	<b>0</b>	<b>0</b>	<b>38.6</b>	<b>45.3</b>
<b>00-00</b>	<b>462</b>	<b>0</b>	<b>10</b>	<b>9</b>	<b>28</b>	<b>146</b>	<b>162</b>	<b>84</b>	<b>21</b>	<b>2</b>	<b>0</b>	<b>0</b>	<b>0</b>	<b>0</b>	<b>0</b>	<b>0</b>	<b>38.6</b>	<b>45.3</b>

28 July 2021

Time	Total	Vbin 6 12	Vbin 12 19	Vbin 19 25	Vbin 25 31	Vbin 31 37	Vbin 37 43	Vbin 43 50	Vbin 50 56	Vbin 56 62	Vbin 62 68	Vbin 68 75	Vbin 75 81	Vbin 81 87	Vbin 87 93	Vbin 93 99	Mean	Vpp 85
0000	3	0	0	0	0	1	2	0	0	0	0	0	0	0	0	0	39	-
0100	0	0	0	0	0	0	0	0	0	0	0	0	0	0	0	0	-	-
0200	2	0	0	0	1	0	0	0	1	0	0	0	0	0	0	0	39.6	-
0300	0	0	0	0	0	0	0	0	0	0	0	0	0	0	0	0	-	-
0400	2	0	0	0	0	0	1	1	0	0	0	0	0	0	0	0	44.1	-
0500	10	0	0	0	0	3	3	2	2	0	0	0	0	0	0	0	42.1	-
0600	27	0	0	0	1	5	13	5	3	0	0	0	0	0	0	0	41.5	47.6
0700	40	0	0	0	0	5	15	19	1	0	0	0	0	0	0	0	42.6	46.7
0800	40	0	1	1	2	15	12	9	0	0	0	0	0	0	0	0	37.6	44.4
0900	38	0	3	0	1	10	19	5	0	0	0	0	0	0	0	0	37.5	43.5
1000	29	0	1	0	2	6	14	6	0	0	0	0	0	0	0	0	38.8	46.1
1100	36	0	2	0	3	14	12	4	1	0	0	0	0	0	0	0	36.4	43.5
1200	34	0	2	1	3	7	16	5	0	0	0	0	0	0	0	0	36.9	44.4
1300	28	0	0	0	1	11	8	6	2	0	0	0	0	0	0	0	39.5	47.3
1400	31	0	3	1	1	8	12	6	0	0	0	0	0	0	0	0	36	45.3
1500	29	0	0	0	2	16	9	2	0	0	0	0	0	0	0	0	36.6	40.3
1600	37	0	1	1	1	7	17	9	1	0	0	0	0	0	0	0	39.5	45.3
1700	42	0	1	0	2	10	20	6	3	0	0	0	0	0	0	0	39.6	46.3
1800	21	0	0	0	1	3	12	4	1	0	0	0	0	0	0	0	40.7	44.3
1900	30	0	1	0	0	10	14	3	2	0	0	0	0	0	0	0	38.6	43.7
2000	18	0	0	0	3	6	6	0	2	1	0	0	0	0	0	0	38.3	50.9
2100	8	0	0	0	0	2	4	2	0	0	0	0	0	0	0	0	38.8	-
2200	4	0	0	0	1	1	1	0	1	0	0	0	0	0	0	0	39.1	-
2300	2	0	0	0	0	1	0	0	0	1	0	0	0	0	0	0	45	-
<b>07-19</b>	<b>405</b>	<b>0</b>	<b>14</b>	<b>4</b>	<b>19</b>	<b>112</b>	<b>166</b>	<b>81</b>	<b>9</b>	<b>0</b>	<b>0</b>	<b>0</b>	<b>0</b>	<b>0</b>	<b>0</b>	<b>0</b>	<b>38.5</b>	<b>44.9</b>
<b>06-22</b>	<b>488</b>	<b>0</b>	<b>15</b>	<b>4</b>	<b>23</b>	<b>135</b>	<b>203</b>	<b>91</b>	<b>16</b>	<b>1</b>	<b>0</b>	<b>0</b>	<b>0</b>	<b>0</b>	<b>0</b>	<b>0</b>	<b>38.7</b>	<b>45</b>
<b>06-00</b>	<b>494</b>	<b>0</b>	<b>15</b>	<b>4</b>	<b>24</b>	<b>137</b>	<b>204</b>	<b>91</b>	<b>17</b>	<b>2</b>	<b>0</b>	<b>0</b>	<b>0</b>	<b>0</b>	<b>0</b>	<b>0</b>	<b>38.7</b>	<b>45</b>
<b>00-00</b>	<b>511</b>	<b>0</b>	<b>15</b>	<b>4</b>	<b>25</b>	<b>141</b>	<b>210</b>	<b>94</b>	<b>20</b>	<b>2</b>	<b>0</b>	<b>0</b>	<b>0</b>	<b>0</b>	<b>0</b>	<b>0</b>	<b>38.8</b>	<b>45.1</b>

**Grand Total**

Time	Total	Vbin 6 12	Vbin 12 19	Vbin 19 25	Vbin 25 31	Vbin 31 37	Vbin 37 43	Vbin 43 50	Vbin 50 56	Vbin 56 62	Vbin 62 68	Vbin 68 75	Vbin 75 81	Vbin 81 87	Vbin 87 93	Vbin 93 99	Mean	Vpp 85
--	3624	6	91	90	246	1137	1357	565	118	14	0	0	0	0	0	0	37.9	44.5

# K&M TRAFFIC SURVEYS

SITE: SHEEPHURST LN WEST

LOCATION: ATTACHED TO TELEGRAPH POLE

GRID REFERENCE: 51.171520, 0.457180

DIRECTION: EASTBOUND

SPEED LIMIT: 50

22-Jul

Time [--	Total	Vbin 6 12	Vbin 12 19	Vbin 19 25	Vbin 25 31	Vbin 31 37	Vbin 37 43	Vbin 43 50	Vbin 50 56	Vbin 56 62	Vbin 62 68	Vbin 68 75	Vbin 75 81	Vbin 81 87	Vbin 87 93	Vbin 93 99	Mean	Vpp 85
0000	3	0	0	0	0	0	1	2	0	0	0	0	0	0	0	0	34.7	-
0100	1	0	0	0	0	0	0	0	0	0	1	0	0	0	0	0	39	-
0200	0	0	0	0	0	0	0	0	0	0	0	0	0	0	0	0	-	-
0300	2	0	0	0	0	1	1	0	0	0	0	0	0	0	0	0	42.9	-
0400	3	0	0	0	0	1	2	0	0	0	0	0	0	0	0	0	42.3	-
0500	7	0	0	0	0	0	3	4	0	0	0	0	0	0	0	0	44.6	52.9
0600	19	0	0	0	0	0	4	10	3	2	0	0	0	0	0	0	40.5	51.2
0700	33	0	0	0	1	1	17	8	5	1	0	0	0	0	0	0	42.1	49.9
0800	53	0	0	1	3	6	15	20	6	2	0	0	0	0	0	0	39.8	47.2
0900	43	0	0	0	4	14	7	15	2	1	0	0	0	0	0	0	40.2	45.1
1000	33	0	0	2	3	8	12	6	2	0	0	0	0	0	0	0	39.1	44.7
1100	27	0	0	0	1	5	12	8	1	0	0	0	0	0	0	0	37	43.4
1200	35	0	0	0	5	5	15	7	3	0	0	0	0	0	0	0	40.4	46
1300	22	0	0	0	1	5	9	4	3	0	0	0	0	0	0	0	37.8	43.8
1400	27	0	0	0	0	5	8	12	2	0	0	0	0	0	0	0	39.2	46.6
1500	24	0	0	0	0	7	9	5	3	0	0	0	0	0	0	0	40.4	46.8
1600	56	0	0	0	3	11	21	13	7	1	0	0	0	0	0	0	39.4	45.9
1700	56	0	0	1	2	4	17	18	10	2	2	0	0	0	0	0	38.7	44.4
1800	39	0	0	0	0	1	14	17	5	0	2	0	0	0	0	0	41	48.9
1900	22	0	0	0	0	2	8	8	2	1	1	0	0	0	0	0	43.4	50.8
2000	9	0	0	0	0	2	3	2	1	1	0	0	0	0	0	0	41.7	48.3
2100	13	0	0	0	0	0	6	3	0	2	2	0	0	0	0	0	43.4	48.7
2200	7	0	0	0	0	1	2	3	1	0	0	0	0	0	0	0	42.5	51.2
2300	3	0	0	0	0	2	0	1	0	0	0	0	0	0	0	0	45.8	-
<b>07-19</b>	<b>448</b>	<b>0</b>	<b>0</b>	<b>4</b>	<b>23</b>	<b>72</b>	<b>156</b>	<b>133</b>	<b>49</b>	<b>7</b>	<b>4</b>	<b>0</b>	<b>0</b>	<b>0</b>	<b>0</b>	<b>0</b>	<b>39.5</b>	<b>46</b>
<b>06-22</b>	<b>511</b>	<b>0</b>	<b>0</b>	<b>4</b>	<b>23</b>	<b>76</b>	<b>177</b>	<b>156</b>	<b>55</b>	<b>13</b>	<b>7</b>	<b>0</b>	<b>0</b>	<b>0</b>	<b>0</b>	<b>0</b>	<b>39.8</b>	<b>46.4</b>
<b>06-00</b>	<b>521</b>	<b>0</b>	<b>0</b>	<b>4</b>	<b>23</b>	<b>79</b>	<b>179</b>	<b>160</b>	<b>56</b>	<b>13</b>	<b>7</b>	<b>0</b>	<b>0</b>	<b>0</b>	<b>0</b>	<b>0</b>	<b>39.8</b>	<b>46.4</b>
<b>00-00</b>	<b>537</b>	<b>0</b>	<b>0</b>	<b>4</b>	<b>23</b>	<b>81</b>	<b>186</b>	<b>166</b>	<b>56</b>	<b>13</b>	<b>8</b>	<b>0</b>	<b>0</b>	<b>0</b>	<b>0</b>	<b>0</b>	<b>39.8</b>	<b>46.5</b>





0200	1	0	0	0	0	0	0	0	0	1	0	0	0	0	0	0	43.6	-
0300	0	0	0	0	0	0	0	0	0	0	0	0	0	0	0	0	-	-
0400	0	0	0	0	0	0	0	0	0	0	0	0	0	0	0	0	37.4	-
0500	7	0	0	0	0	0	1	3	2	1	0	0	0	0	0	0	47.1	57.9
0600	13	0	0	0	0	0	5	5	2	1	0	0	0	0	0	0	41.3	53
0700	21	0	0	1	1	1	2	12	2	1	1	0	0	0	0	0	42.2	48.5
0800	19	0	1	1	0	1	4	7	4	1	0	0	0	0	0	0	40.4	46.5
0900	34	1	1	1	2	5	8	14	2	0	0	0	0	0	0	0	39.6	45.6
1000	36	0	1	1	0	3	16	10	4	1	0	0	0	0	0	0	38.1	44.4
1100	49	0	2	0	2	0	15	23	5	2	0	0	0	0	0	0	38.1	44
1200	48	0	0	0	2	10	15	16	4	1	0	0	0	0	0	0	37.9	43.9
1300	32	0	0	1	1	2	8	12	4	2	2	0	0	0	0	0	39.3	44.6
1400	31	0	0	1	1	2	10	11	4	2	0	0	0	0	0	0	39.6	44.6
1500	27	0	0	0	3	6	8	7	3	0	0	0	0	0	0	0	39.2	46.1
1600	28	0	0	0	2	2	7	11	5	1	0	0	0	0	0	0	39.9	46.2
1700	32	0	0	0	0	1	8	14	5	3	1	0	0	0	0	0	40.3	47.3
1800	23	0	0	0	1	2	4	9	5	0	1	1	0	0	0	0	39	46.3
1900	22	0	0	0	1	1	6	10	3	0	1	0	0	0	0	0	42.6	48.4
2000	11	0	0	0	0	1	4	3	1	1	1	0	0	0	0	0	43.4	50.4
2100	5	0	0	0	0	0	2	3	0	0	0	0	0	0	0	0	44.6	50.9
2200	2	0	0	0	0	1	0	1	0	0	0	0	0	0	0	0	42.2	50.2
2300	0	0	0	0	0	0	0	0	0	0	0	0	0	0	0	0	43.4	53.9
<b>07-19</b>	<b>380</b>	<b>1</b>	<b>5</b>	<b>6</b>	<b>15</b>	<b>35</b>	<b>105</b>	<b>146</b>	<b>47</b>	<b>14</b>	<b>5</b>	<b>1</b>	<b>0</b>	<b>0</b>	<b>0</b>	<b>0</b>	<b>39.5</b>	<b>45.7</b>
<b>06-22</b>	<b>431</b>	<b>1</b>	<b>5</b>	<b>6</b>	<b>16</b>	<b>37</b>	<b>122</b>	<b>167</b>	<b>53</b>	<b>16</b>	<b>7</b>	<b>1</b>	<b>0</b>	<b>0</b>	<b>0</b>	<b>0</b>	<b>39.8</b>	<b>46.2</b>
<b>06-00</b>	<b>433</b>	<b>1</b>	<b>5</b>	<b>6</b>	<b>16</b>	<b>38</b>	<b>122</b>	<b>168</b>	<b>53</b>	<b>16</b>	<b>7</b>	<b>1</b>	<b>0</b>	<b>0</b>	<b>0</b>	<b>0</b>	<b>39.9</b>	<b>46.2</b>
<b>00-00</b>	<b>449</b>	<b>1</b>	<b>5</b>	<b>6</b>	<b>17</b>	<b>39</b>	<b>127</b>	<b>171</b>	<b>56</b>	<b>19</b>	<b>7</b>	<b>1</b>	<b>0</b>	<b>0</b>	<b>0</b>	<b>0</b>	<b>39.9</b>	<b>46.4</b>

25-Jul

Time [--	Total	Vbin 6 12	Vbin 12 19	Vbin 19 25	Vbin 25 31	Vbin 31 37	Vbin 37 43	Vbin 43 50	Vbin 50 56	Vbin 56 62	Vbin 62 68	Vbin 68 75	Vbin 75 81	Vbin 81 87	Vbin 87 93	Vbin 93 99	Mean	Vpp 85
0000	0	0	0	0	0	0	0	0	0	0	0	0	0	0	0	0	48.9	-
0100	3	0	0	0	0	1	2	0	0	0	0	0	0	0	0	0	37.5	-
0200	0	0	0	0	0	0	0	0	0	0	0	0	0	0	0	0	-	-
0300	0	0	0	0	0	0	0	0	0	0	0	0	0	0	0	0	54.1	-
0400	0	0	0	0	0	0	0	0	0	0	0	0	0	0	0	0	34.7	-
0500	6	0	0	0	0	0	1	4	0	1	0	0	0	0	0	0	46.2	56.8
0600	5	0	0	0	0	0	3	1	1	0	0	0	0	0	0	0	40	48.4
0700	23	0	0	0	0	1	3	12	5	2	0	0	0	0	0	0	44.7	52.7
0800	13	0	0	0	0	1	4	5	2	1	0	0	0	0	0	0	42.8	48.5

0900	31	0	0	0	1	1	13	7	7	1	1	0	0	0	0	0	39.7	45.5
1000	29	0	0	3	0	3	12	5	5	1	0	0	0	0	0	0	37.9	46
1100	31	0	0	1	1	4	14	8	1	2	0	0	0	0	0	0	38.5	45.1
1200	40	0	0	0	0	0	17	17	5	1	0	0	0	0	0	0	38.6	44.9
1300	46	0	0	0	0	8	14	18	4	1	1	0	0	0	0	0	39.2	44.7
1400	17	0	0	1	0	0	10	4	2	0	0	0	0	0	0	0	38.5	42.6
1500	25	0	0	1	0	0	9	11	4	0	0	0	0	0	0	0	40.3	45.1
1600	26	0	0	0	0	1	11	10	2	2	0	0	0	0	0	0	40.2	46.6
1700	12	0	0	0	1	2	1	5	3	0	0	0	0	0	0	0	39.8	45.3
1800	17	0	0	0	0	0	5	5	7	0	0	0	0	0	0	0	40.1	45.7
1900	15	0	0	0	0	1	4	4	6	0	0	0	0	0	0	0	41.7	47.7
2000	14	0	0	0	0	0	6	4	2	2	0	0	0	0	0	0	45.6	53.9
2100	10	0	0	0	0	2	4	3	0	0	1	0	0	0	0	0	42.4	51.8
2200	9	0	0	0	0	3	3	3	0	0	0	0	0	0	0	0	41.1	46.4
2300	4	0	0	0	0	0	1	2	1	0	0	0	0	0	0	0	40.2	48.8
<b>07-19</b>	<b>310</b>	<b>0</b>	<b>0</b>	<b>6</b>	<b>3</b>	<b>21</b>	<b>113</b>	<b>107</b>	<b>47</b>	<b>11</b>	<b>2</b>	<b>0</b>	<b>0</b>	<b>0</b>	<b>0</b>	<b>0</b>	<b>39.6</b>	<b>45.7</b>
<b>06-22</b>	<b>354</b>	<b>0</b>	<b>0</b>	<b>6</b>	<b>3</b>	<b>24</b>	<b>130</b>	<b>119</b>	<b>56</b>	<b>13</b>	<b>3</b>	<b>0</b>	<b>0</b>	<b>0</b>	<b>0</b>	<b>0</b>	<b>39.8</b>	<b>46.1</b>
<b>06-00</b>	<b>367</b>	<b>0</b>	<b>0</b>	<b>6</b>	<b>3</b>	<b>27</b>	<b>134</b>	<b>124</b>	<b>57</b>	<b>13</b>	<b>3</b>	<b>0</b>	<b>0</b>	<b>0</b>	<b>0</b>	<b>0</b>	<b>39.9</b>	<b>46.2</b>
<b>00-00</b>	<b>376</b>	<b>0</b>	<b>0</b>	<b>6</b>	<b>3</b>	<b>28</b>	<b>137</b>	<b>128</b>	<b>57</b>	<b>14</b>	<b>3</b>	<b>0</b>	<b>0</b>	<b>0</b>	<b>0</b>	<b>0</b>	<b>39.9</b>	<b>46.3</b>

**26-Jul**

Time [--	Total	Vbin 6 12	Vbin 12 19	Vbin 19 25	Vbin 25 31	Vbin 31 37	Vbin 37 43	Vbin 43 50	Vbin 50 56	Vbin 56 62	Vbin 62 68	Vbin 68 75	Vbin 75 81	Vbin 81 87	Vbin 87 93	Vbin 93 99	Mean	Vpp 85
0000	0	0	0	0	0	0	0	0	0	0	0	0	0	0	0	0	43.4	-
0100	0	0	0	0	0	0	0	0	0	0	0	0	0	0	0	0	45	-
0200	0	0	0	0	0	0	0	0	0	0	0	0	0	0	0	0	46.7	-
0300	1	0	0	0	0	0	1	0	0	0	0	0	0	0	0	0	-	-
0400	0	0	0	0	0	0	0	0	0	0	0	0	0	0	0	0	51.6	-
0500	15	0	0	0	0	0	2	7	5	1	0	0	0	0	0	0	45.3	-
0600	21	0	0	0	2	0	11	7	0	1	0	0	0	0	0	0	42.7	53.4
0700	27	0	0	0	1	0	8	12	4	2	0	0	0	0	0	0	39.5	49.5
0800	58	0	2	0	3	13	25	9	6	0	0	0	0	0	0	0	41.3	50.1
0900	30	0	1	0	4	1	13	7	4	0	0	0	0	0	0	0	40.9	47.3
1000	26	0	0	0	2	10	7	5	2	0	0	0	0	0	0	0	39.9	46.9
1100	31	0	0	0	1	1	14	12	1	0	1	1	0	0	0	0	35.9	42.5
1200	28	0	0	0	3	6	10	7	2	0	0	0	0	0	0	0	38.2	45
1300	23	0	0	2	4	3	8	5	1	0	0	0	0	0	0	0	38.6	45.4
1400	26	0	0	2	5	5	5	6	3	0	0	0	0	0	0	0	38.4	44.8
1500	35	0	1	1	1	6	15	8	3	0	0	0	0	0	0	0	40.3	46.3



2300	2	0	0	0	0	0	0	1	1	0	0	0	0	0	0	0	0	40.1	-
<b>07-19</b>	<b>473</b>	<b>0</b>	<b>2</b>	<b>5</b>	<b>30</b>	<b>64</b>	<b>151</b>	<b>142</b>	<b>68</b>	<b>8</b>	<b>2</b>	<b>1</b>	<b>0</b>	<b>0</b>	<b>0</b>	<b>0</b>	<b>0</b>	<b>39.8</b>	<b>45.9</b>
<b>06-22</b>	<b>534</b>	<b>0</b>	<b>2</b>	<b>6</b>	<b>32</b>	<b>69</b>	<b>174</b>	<b>166</b>	<b>72</b>	<b>9</b>	<b>3</b>	<b>1</b>	<b>0</b>	<b>0</b>	<b>0</b>	<b>0</b>	<b>0</b>	<b>39.8</b>	<b>46.1</b>
<b>06-00</b>	<b>542</b>	<b>0</b>	<b>2</b>	<b>6</b>	<b>32</b>	<b>69</b>	<b>177</b>	<b>169</b>	<b>74</b>	<b>9</b>	<b>3</b>	<b>1</b>	<b>0</b>	<b>0</b>	<b>0</b>	<b>0</b>	<b>0</b>	<b>39.9</b>	<b>46.1</b>
<b>00-00</b>	<b>563</b>	<b>0</b>	<b>2</b>	<b>6</b>	<b>32</b>	<b>71</b>	<b>186</b>	<b>174</b>	<b>78</b>	<b>10</b>	<b>3</b>	<b>1</b>	<b>0</b>	<b>0</b>	<b>0</b>	<b>0</b>	<b>0</b>	<b>40</b>	<b>46.4</b>

28-Jul

Time [--	Total	Vbin 6 12	Vbin 12 19	Vbin 19 25	Vbin 25 31	Vbin 31 37	Vbin 37 43	Vbin 43 50	Vbin 50 56	Vbin 56 62	Vbin 62 68	Vbin 68 75	Vbin 75 81	Vbin 81 87	Vbin 87 93	Vbin 93 99	Mean	Vpp 85
0000	2	0	0	0	0	1	0	0	0	1	0	0	0	0	0	0	48.7	-
0100	0	0	0	0	0	0	0	0	0	0	0	0	0	0	0	0	-	-
0200	0	0	0	0	0	0	0	0	0	0	0	0	0	0	0	0	-	-
0300	0	0	0	0	0	0	0	0	0	0	0	0	0	0	0	0	48.5	-
0400	2	0	0	0	0	1	1	0	0	0	0	0	0	0	0	0	51.7	-
0500	6	0	0	0	0	1	1	1	2	1	0	0	0	0	0	0	47.2	53
0600	20	0	0	0	0	2	6	7	5	0	0	0	0	0	0	0	42.7	51.4
0700	42	0	0	0	4	3	15	15	4	1	0	0	0	0	0	0	41.1	47.1
0800	70	0	0	4	2	12	23	18	8	3	0	0	0	0	0	0	39.8	46.5
0900	44	0	0	0	4	8	16	12	3	1	0	0	0	0	0	0	39.4	45
1000	28	0	0	1	0	6	9	11	1	0	0	0	0	0	0	0	39.1	46
1100	31	0	1	0	4	8	11	6	1	0	0	0	0	0	0	0	38.1	45.3
1200	33	0	0	0	1	4	19	4	5	0	0	0	0	0	0	0	38.9	45.3
1300	28	0	0	0	0	5	8	12	2	1	0	0	0	0	0	0	38.6	44
1400	39	0	0	1	1	5	15	13	3	1	0	0	0	0	0	0	37.3	43.3
1500	42	0	1	1	4	4	15	12	4	0	1	0	0	0	0	0	39.5	46.3
1600	64	0	0	1	4	13	17	21	5	3	0	0	0	0	0	0	38.6	46.2
1700	59	0	0	0	1	2	24	27	3	2	0	0	0	0	0	0	39.8	47.5
1800	35	0	0	0	0	2	7	23	3	0	0	0	0	0	0	0	39.9	48.7
1900	20	0	0	0	0	4	3	11	1	1	0	0	0	0	0	0	39.5	47.7
2000	12	0	0	0	0	1	1	9	1	0	0	0	0	0	0	0	43	50.6
2100	11	0	0	0	0	1	4	2	1	2	0	1	0	0	0	0	40.8	47.5
2200	11	0	0	0	0	2	3	4	1	1	0	0	0	0	0	0	42.3	51.8
2300	7	0	0	0	0	2	2	2	0	1	0	0	0	0	0	0	40.1	-
<b>07-19</b>	<b>515</b>	<b>0</b>	<b>2</b>	<b>8</b>	<b>25</b>	<b>72</b>	<b>179</b>	<b>174</b>	<b>42</b>	<b>12</b>	<b>1</b>	<b>0</b>	<b>0</b>	<b>0</b>	<b>0</b>	<b>0</b>	<b>39.2</b>	<b>45.9</b>
<b>06-22</b>	<b>578</b>	<b>0</b>	<b>2</b>	<b>8</b>	<b>25</b>	<b>80</b>	<b>193</b>	<b>203</b>	<b>50</b>	<b>15</b>	<b>1</b>	<b>1</b>	<b>0</b>	<b>0</b>	<b>0</b>	<b>0</b>	<b>39.4</b>	<b>46.3</b>
<b>06-00</b>	<b>596</b>	<b>0</b>	<b>2</b>	<b>8</b>	<b>25</b>	<b>84</b>	<b>198</b>	<b>209</b>	<b>51</b>	<b>17</b>	<b>1</b>	<b>1</b>	<b>0</b>	<b>0</b>	<b>0</b>	<b>0</b>	<b>39.4</b>	<b>46.4</b>
<b>00-00</b>	<b>606</b>	<b>0</b>	<b>2</b>	<b>8</b>	<b>25</b>	<b>87</b>	<b>200</b>	<b>210</b>	<b>53</b>	<b>19</b>	<b>1</b>	<b>1</b>	<b>0</b>	<b>0</b>	<b>0</b>	<b>0</b>	<b>39.5</b>	<b>46.5</b>

**Grand Total**

Time [--	Total	Vbin 6 12	Vbin 12 19	Vbin 19 25	Vbin 25 31	Vbin 31 37	Vbin 37 43	Vbin 43 50	Vbin 50 56	Vbin 56 62	Vbin 62 68	Vbin 68 75	Vbin 75 81	Vbin 81 87	Vbin 87 93	Vbin 93 99	Mean	Vpp 85
--	3623	1	13	38	164	440	1218	1196	419	98	30	6	0	0	0	0	39.9	45.9

# K&M TRAFFIC SURVEYS

SITE: COLLIER ST SOUTH

LOCATION: ATTACHED TO TELEGRAPH POLE

GRID REFERENCE: 51.175390, 0.452482

DIRECTION: NORTHBOUND    SPEED LIMIT: 50

21 July 2021

Time	Total	Vbin 6 12	Vbin 12 19	Vbin 19 25	Vbin 25 31	Vbin 31 37	Vbin 37 43	Vbin 43 50	Vbin 50 56	Vbin 56 62	Vbin 62 68	Vbin 68 75	Vbin 75 81	Vbin 81 87	Vbin 87 93	Vbin 93 99	Mean	Vpp 85
0900	43	0	1	0	6	7	25	4	0	0	0	0	0	0	0	0	37.7	42.2
1000	105	0	2	4	15	40	34	8	1	1	0	0	0	0	0	0	36	42.8
1100	120	1	4	18	29	45	19	4	0	0	0	0	0	0	0	0	31.5	38.3
1200	156	1	4	9	15	49	57	18	3	0	0	0	0	0	0	0	36.3	42.7
1300	176	3	11	10	54	54	31	9	2	1	1	0	0	0	0	0	32.1	39.6
1400	151	0	2	0	9	45	71	21	3	0	0	0	0	0	0	0	38.4	43.9
1500	195	0	2	4	12	75	84	15	3	0	0	0	0	0	0	0	37.5	42.1
1600	239	2	0	1	15	62	107	44	5	2	0	1	0	0	0	0	39.2	44.6
1700	248	0	1	4	6	56	137	40	4	0	0	0	0	0	0	0	39.4	44.2
1800	154	0	0	2	3	42	74	23	9	1	0	0	0	0	0	0	40.2	46
1900	108	0	0	5	3	24	50	21	4	1	0	0	0	0	0	0	39.6	45
2000	95	0	2	0	1	27	37	18	10	0	0	0	0	0	0	0	40.4	47.3
2100	70	0	0	0	2	16	25	17	8	2	0	0	0	0	0	0	42	49.1
2200	31	0	0	0	1	10	12	7	1	0	0	0	0	0	0	0	40.1	46.9
2300	23	0	0	0	4	4	7	4	4	0	0	0	0	0	0	0	40	50.3
<b>07-19</b>	<b>1587</b>	<b>7</b>	<b>27</b>	<b>52</b>	<b>164</b>	<b>475</b>	<b>639</b>	<b>186</b>	<b>30</b>	<b>5</b>	<b>1</b>	<b>1</b>	<b>0</b>	<b>0</b>	<b>0</b>	<b>0</b>	<b>37.1</b>	<b>43.2</b>
<b>06-22</b>	<b>1860</b>	<b>7</b>	<b>29</b>	<b>57</b>	<b>170</b>	<b>542</b>	<b>751</b>	<b>242</b>	<b>52</b>	<b>8</b>	<b>1</b>	<b>1</b>	<b>0</b>	<b>0</b>	<b>0</b>	<b>0</b>	<b>37.6</b>	<b>43.8</b>
<b>06-00</b>	<b>1914</b>	<b>7</b>	<b>29</b>	<b>57</b>	<b>175</b>	<b>556</b>	<b>770</b>	<b>253</b>	<b>57</b>	<b>8</b>	<b>1</b>	<b>1</b>	<b>0</b>	<b>0</b>	<b>0</b>	<b>0</b>	<b>37.7</b>	<b>44</b>
<b>00-00</b>	<b>1914</b>	<b>7</b>	<b>29</b>	<b>57</b>	<b>175</b>	<b>556</b>	<b>770</b>	<b>253</b>	<b>57</b>	<b>8</b>	<b>1</b>	<b>1</b>	<b>0</b>	<b>0</b>	<b>0</b>	<b>0</b>	<b>37.7</b>	<b>44</b>

22 July 2021

Time	Total	Vbin 6 12	Vbin 12 19	Vbin 19 25	Vbin 25 31	Vbin 31 37	Vbin 37 43	Vbin 43 50	Vbin 50 56	Vbin 56 62	Vbin 62 68	Vbin 68 75	Vbin 75 81	Vbin 81 87	Vbin 87 93	Vbin 93 99	Mean	Vpp 85
0000	9	0	0	0	2	0	4	3	0	0	0	0	0	0	0	0	40.4	-
0100	4	0	0	0	0	0	3	0	0	0	1	0	0	0	0	0	47.3	-
0200	6	0	0	0	0	1	4	1	0	0	0	0	0	0	0	0	40.7	-
0300	7	0	0	0	1	1	3	2	0	0	0	0	0	0	0	0	40.3	-
0400	10	0	0	0	1	2	1	5	0	1	0	0	0	0	0	0	42.5	-
0500	21	0	0	0	2	5	8	4	2	0	0	0	0	0	0	0	40.7	48.7
0600	109	0	5	2	4	16	47	32	2	1	0	0	0	0	0	0	39.3	45.6
0700	165	0	6	9	22	39	51	33	5	0	0	0	0	0	0	0	36.8	45.1
0800	183	0	2	7	19	52	74	26	2	1	0	0	0	0	0	0	37.6	43.6
0900	154	0	2	1	10	54	66	19	1	1	0	0	0	0	0	0	38.2	43.5
1000	137	0	1	3	17	44	54	16	2	0	0	0	0	0	0	0	36.9	42.7
1100	137	0	0	2	12	49	53	18	3	0	0	0	0	0	0	0	38.1	44
1200	142	0	4	5	12	59	40	20	1	1	0	0	0	0	0	0	36.5	43.6
1300	181	0	4	4	13	63	67	28	2	0	0	0	0	0	0	0	37.5	43.7
1400	182	0	1	1	0	82	70	27	1	0	0	0	0	0	0	0	38.3	43.7
1500	206	0	0	1	17	67	80	34	6	1	0	0	0	0	0	0	38.8	44.5
1600	268	0	0	1	39	93	105	24	6	0	0	0	0	0	0	0	37.3	42.7
1700	264	0	5	3	14	63	133	38	7	0	1	0	0	0	0	0	38.9	44.3
1800	187	0	1	1	7	46	96	31	5	0	0	0	0	0	0	0	39.7	44.8
1900	120	0	2	3	11	24	52	24	4	0	0	0	0	0	0	0	38.9	45.8
2000	100	0	0	2	1	17	52	22	5	1	0	0	0	0	0	0	41.2	46.4
2100	42	0	0	0	1	16	16	6	1	1	1	0	0	0	0	0	40.1	46.8
2200	43	0	0	1	5	8	11	13	4	1	0	0	0	0	0	0	40.8	48.7
2300	27	0	0	0	0	5	10	8	4	0	0	0	0	0	0	0	43	50
<b>07-19</b>	<b>2206</b>	<b>0</b>	<b>26</b>	<b>38</b>	<b>182</b>	<b>711</b>	<b>889</b>	<b>314</b>	<b>41</b>	<b>4</b>	<b>1</b>	<b>0</b>	<b>0</b>	<b>0</b>	<b>0</b>	<b>0</b>	<b>37.9</b>	<b>43.7</b>
<b>06-22</b>	<b>2577</b>	<b>0</b>	<b>33</b>	<b>45</b>	<b>199</b>	<b>784</b>	<b>1056</b>	<b>398</b>	<b>53</b>	<b>7</b>	<b>2</b>	<b>0</b>	<b>0</b>	<b>0</b>	<b>0</b>	<b>0</b>	<b>38.2</b>	<b>44.2</b>
<b>06-00</b>	<b>2647</b>	<b>0</b>	<b>33</b>	<b>46</b>	<b>204</b>	<b>797</b>	<b>1077</b>	<b>419</b>	<b>61</b>	<b>8</b>	<b>2</b>	<b>0</b>	<b>0</b>	<b>0</b>	<b>0</b>	<b>0</b>	<b>38.3</b>	<b>44.3</b>
<b>00-00</b>	<b>2704</b>	<b>0</b>	<b>33</b>	<b>46</b>	<b>210</b>	<b>806</b>	<b>1100</b>	<b>434</b>	<b>63</b>	<b>9</b>	<b>3</b>	<b>0</b>	<b>0</b>	<b>0</b>	<b>0</b>	<b>0</b>	<b>38.4</b>	<b>44.4</b>



23 July 2021

Time	Total	Vbin 6 12	Vbin 12 19	Vbin 19 25	Vbin 25 31	Vbin 31 37	Vbin 37 43	Vbin 43 50	Vbin 50 56	Vbin 56 62	Vbin 62 68	Vbin 68 75	Vbin 75 81	Vbin 81 87	Vbin 87 93	Vbin 93 99	Mean	Vpp 85
0000	8	0	0	1	0	2	2	3	0	0	0	0	0	0	0	0	39.8	-
0100	1	0	0	0	0	0	0	0	0	1	0	0	0	0	0	0	61.3	-
0200	6	0	0	0	0	2	4	0	0	0	0	0	0	0	0	0	38.7	-
0300	3	0	0	0	1	1	0	1	0	0	0	0	0	0	0	0	37.7	-
0400	8	0	0	0	1	1	2	3	1	0	0	0	0	0	0	0	42.4	-
0500	13	0	0	1	0	6	3	3	0	0	0	0	0	0	0	0	37.8	44.5
0600	71	0	1	1	0	10	24	23	11	0	1	0	0	0	0	0	42.9	50.1
0700	157	0	0	1	3	37	68	37	11	0	0	0	0	0	0	0	40.7	46.5
0800	171	0	0	2	3	54	82	28	1	1	0	0	0	0	0	0	39.3	44.5
0900	128	0	0	2	7	48	60	11	0	0	0	0	0	0	0	0	37.6	42.4
1000	140	0	1	2	18	50	53	12	3	0	1	0	0	0	0	0	37.2	42.9
1100	139	1	3	1	22	50	45	14	2	1	0	0	0	0	0	0	36.4	42.7
1200	155	0	1	3	6	47	78	16	1	3	0	0	0	0	0	0	38.6	43
1300	149	0	1	3	14	52	62	12	4	1	0	0	0	0	0	0	37.4	42.8
1400	176	1	2	2	18	45	73	33	0	0	1	1	0	0	0	0	38.4	44.6
1500	220	0	7	5	11	59	96	37	4	1	0	0	0	0	0	0	38.3	44.4
1600	241	0	1	0	13	73	123	28	2	1	0	0	0	0	0	0	38.7	43
1700	252	0	1	2	21	76	103	40	7	2	0	0	0	0	0	0	38.5	44.7
1800	145	0	0	1	4	26	77	28	8	0	0	0	1	0	0	0	40.9	45.6
1900	100	0	0	2	8	20	41	22	6	1	0	0	0	0	0	0	39.9	46.6
2000	71	0	2	3	3	12	25	18	7	0	1	0	0	0	0	0	40.7	48.4
2100	41	0	0	0	3	10	19	7	2	0	0	0	0	0	0	0	39	45
2200	36	0	0	0	0	8	14	13	1	0	0	0	0	0	0	0	41.7	47.5
2300	17	0	0	0	0	4	8	3	1	0	1	0	0	0	0	0	42.3	49.1
<b>07-19</b>	<b>2073</b>	<b>2</b>	<b>17</b>	<b>24</b>	<b>140</b>	<b>617</b>	<b>920</b>	<b>296</b>	<b>43</b>	<b>10</b>	<b>2</b>	<b>1</b>	<b>1</b>	<b>0</b>	<b>0</b>	<b>0</b>	<b>38.5</b>	<b>44</b>
<b>06-22</b>	<b>2356</b>	<b>2</b>	<b>20</b>	<b>30</b>	<b>154</b>	<b>669</b>	<b>1029</b>	<b>366</b>	<b>69</b>	<b>11</b>	<b>4</b>	<b>1</b>	<b>1</b>	<b>0</b>	<b>0</b>	<b>0</b>	<b>38.8</b>	<b>44.5</b>
<b>06-00</b>	<b>2409</b>	<b>2</b>	<b>20</b>	<b>30</b>	<b>154</b>	<b>681</b>	<b>1051</b>	<b>382</b>	<b>71</b>	<b>11</b>	<b>5</b>	<b>1</b>	<b>1</b>	<b>0</b>	<b>0</b>	<b>0</b>	<b>38.9</b>	<b>44.6</b>
<b>00-00</b>	<b>2448</b>	<b>2</b>	<b>20</b>	<b>32</b>	<b>156</b>	<b>693</b>	<b>1062</b>	<b>392</b>	<b>72</b>	<b>12</b>	<b>5</b>	<b>1</b>	<b>1</b>	<b>0</b>	<b>0</b>	<b>0</b>	<b>38.9</b>	<b>44.7</b>

24 July 2021

Time	Total	Vbin 6 12	Vbin 12 19	Vbin 19 25	Vbin 25 31	Vbin 31 37	Vbin 37 43	Vbin 43 50	Vbin 50 56	Vbin 56 62	Vbin 62 68	Vbin 68 75	Vbin 75 81	Vbin 81 87	Vbin 87 93	Vbin 93 99	Mean	Vpp 85
0000	16	0	0	0	0	4	7	3	1	0	1	0	0	0	0	0	42.1	48.9
0100	5	0	0	0	1	1	1	1	1	0	0	0	0	0	0	0	39.6	-
0200	5	0	0	0	1	0	4	0	0	0	0	0	0	0	0	0	37.9	-
0300	1	0	0	0	0	1	0	0	0	0	0	0	0	0	0	0	34.3	-
0400	3	1	0	0	0	0	1	1	0	0	0	0	0	0	0	0	32	-
0500	6	0	0	1	0	1	1	2	1	0	0	0	0	0	0	0	41	-
0600	32	0	0	1	0	7	17	4	3	0	0	0	0	0	0	0	40.3	45.9
0700	43	0	0	0	2	12	21	8	0	0	0	0	0	0	0	0	39.4	45.4
0800	73	0	0	1	6	26	29	11	0	0	0	0	0	0	0	0	38.2	44.2
0900	106	1	1	0	2	11	12	10	9	14	9	11	11	7	2	6	59	80.3
1000	76	0	8	18	12	10	7	2	11	0	0	0	1	6	0	1	37.9	55.4
1100	95	10	57	25	2	1	0	0	0	0	0	0	0	0	0	0	16.7	20.7
1200	90	30	54	6	0	0	0	0	0	0	0	0	0	0	0	0	13.8	17.1
1300	68	37	30	1	0	0	0	0	0	0	0	0	0	0	0	0	12.6	15.4
1400	20	7	13	0	0	0	0	0	0	0	0	0	0	0	0	0	12.5	14.7
1500	1	1	0	0	0	0	0	0	0	0	0	0	0	0	0	0	7.2	-
1600	1	1	0	0	0	0	0	0	0	0	0	0	0	0	0	0	10.2	-
1700	1	1	0	0	0	0	0	0	0	0	0	0	0	0	0	0	10.2	-
1800	0	0	0	0	0	0	0	0	0	0	0	0	0	0	0	0	-	-
1900	1	0	0	0	0	1	0	0	0	0	0	0	0	0	0	0	36.1	-
2000	0	0	0	0	0	0	0	0	0	0	0	0	0	0	0	0	-	-
2100	0	0	0	0	0	0	0	0	0	0	0	0	0	0	0	0	-	-
2200	0	0	0	0	0	0	0	0	0	0	0	0	0	0	0	0	-	-
2300	0	0	0	0	0	0	0	0	0	0	0	0	0	0	0	0	-	-
<b>07-19</b>	<b>574</b>	<b>88</b>	<b>163</b>	<b>51</b>	<b>24</b>	<b>60</b>	<b>69</b>	<b>31</b>	<b>20</b>	<b>14</b>	<b>9</b>	<b>11</b>	<b>12</b>	<b>13</b>	<b>2</b>	<b>7</b>	<b>30.6</b>	<b>50.2</b>
<b>06-22</b>	<b>607</b>	<b>88</b>	<b>163</b>	<b>52</b>	<b>24</b>	<b>68</b>	<b>86</b>	<b>35</b>	<b>23</b>	<b>14</b>	<b>9</b>	<b>11</b>	<b>12</b>	<b>13</b>	<b>2</b>	<b>7</b>	<b>31.2</b>	<b>49.7</b>
<b>06-00</b>	<b>607</b>	<b>88</b>	<b>163</b>	<b>52</b>	<b>24</b>	<b>68</b>	<b>86</b>	<b>35</b>	<b>23</b>	<b>14</b>	<b>9</b>	<b>11</b>	<b>12</b>	<b>13</b>	<b>2</b>	<b>7</b>	<b>31.2</b>	<b>49.7</b>
<b>00-00</b>	<b>643</b>	<b>89</b>	<b>163</b>	<b>53</b>	<b>26</b>	<b>75</b>	<b>100</b>	<b>42</b>	<b>26</b>	<b>14</b>	<b>10</b>	<b>11</b>	<b>12</b>	<b>13</b>	<b>2</b>	<b>7</b>	<b>31.7</b>	<b>49.5</b>



26 July 2021

Time	Total	Vbin 6 12	Vbin 12 19	Vbin 19 25	Vbin 25 31	Vbin 31 37	Vbin 37 43	Vbin 43 50	Vbin 50 56	Vbin 56 62	Vbin 62 68	Vbin 68 75	Vbin 75 81	Vbin 81 87	Vbin 87 93	Vbin 93 99	Mean	Vpp 85
0000	0	0	0	0	0	0	0	0	0	0	0	0	0	0	0	0	0	-
0100	0	0	0	0	0	0	0	0	0	0	0	0	0	0	0	0	0	-
0200	0	0	0	0	0	0	0	0	0	0	0	0	0	0	0	0	0	-
0300	0	0	0	0	0	0	0	0	0	0	0	0	0	0	0	0	0	-
0400	0	0	0	0	0	0	0	0	0	0	0	0	0	0	0	0	0	-
0500	0	0	0	0	0	0	0	0	0	0	0	0	0	0	0	0	0	-
0600	0	0	0	0	0	0	0	0	0	0	0	0	0	0	0	0	0	-
0700	0	0	0	0	0	0	0	0	0	0	0	0	0	0	0	0	0	-
0800	0	0	0	0	0	0	0	0	0	0	0	0	0	0	0	0	0	-
0900	0	0	0	0	0	0	0	0	0	0	0	0	0	0	0	0	0	-
1000	0	0	0	0	0	0	0	0	0	0	0	0	0	0	0	0	0	-
1100	0	0	0	0	0	0	0	0	0	0	0	0	0	0	0	0	0	-
1200	0	0	0	0	0	0	0	0	0	0	0	0	0	0	0	0	0	-
1300	0	0	0	0	0	0	0	0	0	0	0	0	0	0	0	0	0	-
1400	0	0	0	0	0	0	0	0	0	0	0	0	0	0	0	0	0	-
1500	2	0	0	2	0	0	0	0	0	0	0	0	0	0	0	0	23.2	-
1600	0	0	0	0	0	0	0	0	0	0	0	0	0	0	0	0	0	-
1700	0	0	0	0	0	0	0	0	0	0	0	0	0	0	0	0	0	-
1800	0	0	0	0	0	0	0	0	0	0	0	0	0	0	0	0	0	-
1900	0	0	0	0	0	0	0	0	0	0	0	0	0	0	0	0	0	-
2000	0	0	0	0	0	0	0	0	0	0	0	0	0	0	0	0	0	-
2100	0	0	0	0	0	0	0	0	0	0	0	0	0	0	0	0	0	-
2200	0	0	0	0	0	0	0	0	0	0	0	0	0	0	0	0	0	-
2300	0	0	0	0	0	0	0	0	0	0	0	0	0	0	0	0	0	-
<b>07-19</b>	<b>2</b>	<b>0</b>	<b>0</b>	<b>2</b>	<b>0</b>	<b>0</b>	<b>0</b>	<b>0</b>	<b>0</b>	<b>0</b>	<b>0</b>	<b>0</b>	<b>0</b>	<b>0</b>	<b>0</b>	<b>0</b>	<b>23.2</b>	<b>-</b>
<b>06-22</b>	<b>2</b>	<b>0</b>	<b>0</b>	<b>2</b>	<b>0</b>	<b>0</b>	<b>0</b>	<b>0</b>	<b>0</b>	<b>0</b>	<b>0</b>	<b>0</b>	<b>0</b>	<b>0</b>	<b>0</b>	<b>0</b>	<b>23.2</b>	<b>-</b>
<b>06-00</b>	<b>2</b>	<b>0</b>	<b>0</b>	<b>2</b>	<b>0</b>	<b>0</b>	<b>0</b>	<b>0</b>	<b>0</b>	<b>0</b>	<b>0</b>	<b>0</b>	<b>0</b>	<b>0</b>	<b>0</b>	<b>0</b>	<b>23.2</b>	<b>-</b>
<b>00-00</b>	<b>2</b>	<b>0</b>	<b>0</b>	<b>2</b>	<b>0</b>	<b>0</b>	<b>0</b>	<b>0</b>	<b>0</b>	<b>0</b>	<b>0</b>	<b>0</b>	<b>0</b>	<b>0</b>	<b>0</b>	<b>0</b>	<b>23.2</b>	<b>-</b>

27 July 2021

Time	Total	Vbin 6 12	Vbin 12 19	Vbin 19 25	Vbin 25 31	Vbin 31 37	Vbin 37 43	Vbin 43 50	Vbin 50 56	Vbin 56 62	Vbin 62 68	Vbin 68 75	Vbin 75 81	Vbin 81 87	Vbin 87 93	Vbin 93 99	Mean	Vpp 85
0000	0	0	0	0	0	0	0	0	0	0	0	0	0	0	0	0	0	-
0100	0	0	0	0	0	0	0	0	0	0	0	0	0	0	0	0	0	-
0200	0	0	0	0	0	0	0	0	0	0	0	0	0	0	0	0	0	-
0300	0	0	0	0	0	0	0	0	0	0	0	0	0	0	0	0	0	-
0400	0	0	0	0	0	0	0	0	0	0	0	0	0	0	0	0	0	-
0500	0	0	0	0	0	0	0	0	0	0	0	0	0	0	0	0	0	-
0600	0	0	0	0	0	0	0	0	0	0	0	0	0	0	0	0	0	-
0700	0	0	0	0	0	0	0	0	0	0	0	0	0	0	0	0	0	-
0800	3	0	0	3	0	0	0	0	0	0	0	0	0	0	0	0	23.2	-
0900	0	0	0	0	0	0	0	0	0	0	0	0	0	0	0	0	0	-
1000	0	0	0	0	0	0	0	0	0	0	0	0	0	0	0	0	0	-
1100	0	0	0	0	0	0	0	0	0	0	0	0	0	0	0	0	0	-
1200	0	0	0	0	0	0	0	0	0	0	0	0	0	0	0	0	0	-
1300	0	0	0	0	0	0	0	0	0	0	0	0	0	0	0	0	0	-
1400	0	0	0	0	0	0	0	0	0	0	0	0	0	0	0	0	0	-
1500	0	0	0	0	0	0	0	0	0	0	0	0	0	0	0	0	0	-
1600	0	0	0	0	0	0	0	0	0	0	0	0	0	0	0	0	0	-
1700	0	0	0	0	0	0	0	0	0	0	0	0	0	0	0	0	0	-
1800	0	0	0	0	0	0	0	0	0	0	0	0	0	0	0	0	0	-
1900	0	0	0	0	0	0	0	0	0	0	0	0	0	0	0	0	0	-
2000	0	0	0	0	0	0	0	0	0	0	0	0	0	0	0	0	0	-
2100	0	0	0	0	0	0	0	0	0	0	0	0	0	0	0	0	0	-
2200	0	0	0	0	0	0	0	0	0	0	0	0	0	0	0	0	0	-
2300	0	0	0	0	0	0	0	0	0	0	0	0	0	0	0	0	0	-
<b>07-19</b>	<b>3</b>	<b>0</b>	<b>0</b>	<b>3</b>	<b>0</b>	<b>0</b>	<b>0</b>	<b>0</b>	<b>0</b>	<b>0</b>	<b>0</b>	<b>0</b>	<b>0</b>	<b>0</b>	<b>0</b>	<b>0</b>	<b>23.2</b>	<b>-</b>
<b>06-22</b>	<b>3</b>	<b>0</b>	<b>0</b>	<b>3</b>	<b>0</b>	<b>0</b>	<b>0</b>	<b>0</b>	<b>0</b>	<b>0</b>	<b>0</b>	<b>0</b>	<b>0</b>	<b>0</b>	<b>0</b>	<b>0</b>	<b>23.2</b>	<b>-</b>
<b>06-00</b>	<b>3</b>	<b>0</b>	<b>0</b>	<b>3</b>	<b>0</b>	<b>0</b>	<b>0</b>	<b>0</b>	<b>0</b>	<b>0</b>	<b>0</b>	<b>0</b>	<b>0</b>	<b>0</b>	<b>0</b>	<b>0</b>	<b>23.2</b>	<b>-</b>
<b>00-00</b>	<b>3</b>	<b>0</b>	<b>0</b>	<b>3</b>	<b>0</b>	<b>0</b>	<b>0</b>	<b>0</b>	<b>0</b>	<b>0</b>	<b>0</b>	<b>0</b>	<b>0</b>	<b>0</b>	<b>0</b>	<b>0</b>	<b>23.2</b>	<b>-</b>



29 July 2021

Time	Total	Vbin 6 12	Vbin 12 19	Vbin 19 25	Vbin 25 31	Vbin 31 37	Vbin 37 43	Vbin 43 50	Vbin 50 56	Vbin 56 62	Vbin 62 68	Vbin 68 75	Vbin 75 81	Vbin 81 87	Vbin 87 93	Vbin 93 99	Mean	Vpp 85	
0000	0	0	0	0	0	0	0	0	0	0	0	0	0	0	0	0	0	-	-
0100	0	0	0	0	0	0	0	0	0	0	0	0	0	0	0	0	0	-	-
0200	0	0	0	0	0	0	0	0	0	0	0	0	0	0	0	0	0	-	-
0300	0	0	0	0	0	0	0	0	0	0	0	0	0	0	0	0	0	-	-
0400	0	0	0	0	0	0	0	0	0	0	0	0	0	0	0	0	0	-	-
0500	0	0	0	0	0	0	0	0	0	0	0	0	0	0	0	0	0	-	-
0600	0	0	0	0	0	0	0	0	0	0	0	0	0	0	0	0	0	-	-
0700	63	0	1	2	0	10	23	22	5	0	0	0	0	0	0	0	0	41.5	48
0800	143	1	0	9	9	34	62	20	7	1	0	0	0	0	0	0	0	38.3	44.8
0900	109	0	0	3	6	20	46	27	6	1	0	0	0	0	0	0	0	40.4	47.1
1000	91	0	1	3	15	19	37	15	1	0	0	0	0	0	0	0	0	37.2	43.8
1100	118	0	0	1	4	34	50	22	5	1	1	0	0	0	0	0	0	40	44.8
1200	100	0	0	0	4	24	45	21	6	0	0	0	0	0	0	0	0	40.3	45
1300	96	0	1	0	4	25	38	21	6	1	0	0	0	0	0	0	0	40.3	46.9
1400	129	0	1	2	7	20	58	27	12	2	0	0	0	0	0	0	0	40.9	47.3
1500	185	1	0	2	6	51	72	44	9	0	0	0	0	0	0	0	0	40	45.7
1600	245	0	0	1	8	80	102	48	4	2	0	0	0	0	0	0	0	39.6	45.1
1700	224	0	3	3	20	55	62	66	12	0	2	0	0	1	0	0	0	40.1	46.8
1800	154	1	5	0	7	18	60	50	6	6	0	0	1	0	0	0	0	41.6	47.9
1900	102	0	0	4	4	17	32	21	16	7	1	0	0	0	0	0	0	43.1	52.7
2000	56	0	0	0	0	3	23	15	9	3	2	1	0	0	0	0	0	46.4	54.4
2100	50	0	0	1	0	14	11	16	3	4	1	0	0	0	0	0	0	43.1	53.4
2200	28	0	0	0	0	2	14	5	4	3	0	0	0	0	0	0	0	44.4	54.3
2300	10	0	0	0	1	0	1	4	1	2	1	0	0	0	0	0	0	48.5	-
<b>07-19</b>	<b>1657</b>	<b>3</b>	<b>12</b>	<b>26</b>	<b>90</b>	<b>390</b>	<b>655</b>	<b>383</b>	<b>79</b>	<b>14</b>	<b>3</b>	<b>0</b>	<b>1</b>	<b>1</b>	<b>0</b>	<b>0</b>	<b>0</b>	<b>40</b>	<b>46.1</b>
<b>06-22</b>	<b>1865</b>	<b>3</b>	<b>12</b>	<b>31</b>	<b>94</b>	<b>424</b>	<b>721</b>	<b>435</b>	<b>107</b>	<b>28</b>	<b>7</b>	<b>1</b>	<b>1</b>	<b>1</b>	<b>0</b>	<b>0</b>	<b>0</b>	<b>40.4</b>	<b>46.8</b>
<b>06-00</b>	<b>1903</b>	<b>3</b>	<b>12</b>	<b>31</b>	<b>95</b>	<b>426</b>	<b>736</b>	<b>444</b>	<b>112</b>	<b>33</b>	<b>8</b>	<b>1</b>	<b>1</b>	<b>1</b>	<b>0</b>	<b>0</b>	<b>0</b>	<b>40.5</b>	<b>46.9</b>
<b>00-00</b>	<b>1903</b>	<b>3</b>	<b>12</b>	<b>31</b>	<b>95</b>	<b>426</b>	<b>736</b>	<b>444</b>	<b>112</b>	<b>33</b>	<b>8</b>	<b>1</b>	<b>1</b>	<b>1</b>	<b>0</b>	<b>0</b>	<b>0</b>	<b>40.5</b>	<b>46.9</b>

30 July 2021

Time	Total	Vbin 6 12	Vbin 12 19	Vbin 19 25	Vbin 25 31	Vbin 31 37	Vbin 37 43	Vbin 43 50	Vbin 50 56	Vbin 56 62	Vbin 62 68	Vbin 68 75	Vbin 75 81	Vbin 81 87	Vbin 87 93	Vbin 93 99	Mean	Vpp 85
0000	4	0	0	0	0	1	2	1	0	0	0	0	0	0	0	0	39.5	-
0100	2	0	0	0	0	0	1	0	1	0	0	0	0	0	0	0	47.7	-
0200	4	0	0	0	0	1	3	0	0	0	0	0	0	0	0	0	38.8	-
0300	4	0	0	0	0	0	2	0	1	0	0	1	0	0	0	0	50.9	-
0400	5	0	0	0	1	1	0	2	1	0	0	0	0	0	0	0	41.2	-
0500	13	0	0	0	1	0	5	3	4	0	0	0	0	0	0	0	43.8	50.9
0600	78	0	0	1	5	18	24	22	8	0	0	0	0	0	0	0	40.9	48.3
0700	144	0	2	8	11	33	54	32	2	1	0	1	0	0	0	0	38.4	45.8
0800	111	1	1	4	3	25	46	24	5	2	0	0	0	0	0	0	39.8	45.8
0900	103	0	0	0	5	34	44	19	1	0	0	0	0	0	0	0	39.1	44.6
1000	106	0	0	0	7	38	52	9	0	0	0	0	0	0	0	0	37.6	42.7
1100	128	3	10	13	10	45	28	16	3	0	0	0	0	0	0	0	33.6	43.5
1200	132	10	16	24	5	15	35	19	8	0	0	0	0	0	0	0	32.2	44.7
1300	114	0	0	0	3	31	60	17	3	0	0	0	0	0	0	0	40	43.8
1400	129	0	1	0	9	30	51	32	6	0	0	0	0	0	0	0	39.9	45.6
1500	177	0	0	0	4	55	83	32	2	1	0	0	0	0	0	0	39.7	44.1
1600	202	0	0	2	8	30	116	37	7	2	0	0	0	0	0	0	40.6	44.9
1700	198	0	0	0	0	22	94	63	16	2	1	0	0	0	0	0	43	48.2
1800	126	0	0	0	4	17	47	40	17	1	0	0	0	0	0	0	43	49.7
1900	101	0	0	0	0	14	42	27	12	4	1	0	1	0	0	0	44.2	51.2
2000	42	0	0	1	3	12	11	11	3	1	0	0	0	0	0	0	40.3	48.1
2100	42	0	0	0	0	12	12	9	5	4	0	0	0	0	0	0	43.5	51.4
2200	37	0	0	0	0	5	14	8	8	1	1	0	0	0	0	0	45.5	53.8
2300	16	0	0	0	2	1	9	0	3	1	0	0	0	0	0	0	42.2	53.9
<b>07-19</b>	<b>1670</b>	<b>14</b>	<b>30</b>	<b>51</b>	<b>69</b>	<b>375</b>	<b>710</b>	<b>340</b>	<b>70</b>	<b>9</b>	<b>1</b>	<b>1</b>	<b>0</b>	<b>0</b>	<b>0</b>	<b>0</b>	<b>39.1</b>	<b>45.6</b>
<b>06-22</b>	<b>1933</b>	<b>14</b>	<b>30</b>	<b>53</b>	<b>77</b>	<b>431</b>	<b>799</b>	<b>409</b>	<b>98</b>	<b>18</b>	<b>2</b>	<b>1</b>	<b>1</b>	<b>0</b>	<b>0</b>	<b>0</b>	<b>39.6</b>	<b>46.2</b>
<b>06-00</b>	<b>1986</b>	<b>14</b>	<b>30</b>	<b>53</b>	<b>79</b>	<b>437</b>	<b>822</b>	<b>417</b>	<b>109</b>	<b>20</b>	<b>3</b>	<b>1</b>	<b>1</b>	<b>0</b>	<b>0</b>	<b>0</b>	<b>39.7</b>	<b>46.4</b>
<b>00-00</b>	<b>2018</b>	<b>14</b>	<b>30</b>	<b>53</b>	<b>81</b>	<b>440</b>	<b>835</b>	<b>423</b>	<b>116</b>	<b>20</b>	<b>3</b>	<b>2</b>	<b>1</b>	<b>0</b>	<b>0</b>	<b>0</b>	<b>39.8</b>	<b>46.5</b>



31 July 2021

Time	Total	Vbin 6 12	Vbin 12 19	Vbin 19 25	Vbin 25 31	Vbin 31 37	Vbin 37 43	Vbin 43 50	Vbin 50 56	Vbin 56 62	Vbin 62 68	Vbin 68 75	Vbin 75 81	Vbin 81 87	Vbin 87 93	Vbin 93 99	Mean	Vpp 85
0000	9	0	0	0	0	3	5	0	0	0	1	0	0	0	0	0	41.6	-
0100	3	0	0	0	0	1	1	0	1	0	0	0	0	0	0	0	43.6	-
0200	4	0	0	0	0	1	2	0	0	1	0	0	0	0	0	0	43.3	-
0300	1	0	0	0	0	0	1	0	0	0	0	0	0	0	0	0	38.6	-
0400	5	0	0	0	0	0	1	2	1	0	0	1	0	0	0	0	49.9	-
0500	6	0	0	0	0	1	0	1	3	1	0	0	0	0	0	0	48.6	-
0600	15	0	0	0	1	7	1	2	2	2	0	0	0	0	0	0	41.2	54.6
0700	56	1	7	6	5	10	12	9	4	2	0	0	0	0	0	0	35	47.9
0800	59	0	2	1	4	12	19	13	6	1	1	0	0	0	0	0	40.6	49.3
0900	72	0	1	0	3	19	27	18	4	0	0	0	0	0	0	0	40.4	47.9
1000	88	0	3	6	5	27	26	18	2	1	0	0	0	0	0	0	37.5	45.5
1100	125	0	4	7	15	33	41	22	3	0	0	0	0	0	0	0	36.7	44.7
1200	104	1	3	9	19	35	26	7	2	1	0	1	0	0	0	0	34.7	42.2
1300	110	0	2	3	11	30	41	15	5	3	0	0	0	0	0	0	38.3	45.7
1400	122	0	0	7	7	35	51	12	7	2	1	0	0	0	0	0	38.7	44.2
1500	113	1	2	3	10	24	58	11	3	0	1	0	0	0	0	0	37.6	43.4
1600	131	0	1	1	5	42	49	26	5	2	0	0	0	0	0	0	39.6	45.3
1700	99	1	0	0	3	26	54	13	2	0	0	0	0	0	0	0	39.2	44.1
1800	86	0	1	0	1	27	34	15	8	0	0	0	0	0	0	0	40.4	47.5
1900	76	0	0	0	4	16	34	17	4	1	0	0	0	0	0	0	40.9	47
2000	34	1	2	0	1	7	15	5	3	0	0	0	0	0	0	0	38.3	45.6
2100	36	0	0	0	1	7	18	9	1	0	0	0	0	0	0	0	40.7	47.8
2200	22	0	0	0	4	7	3	4	4	0	0	0	0	0	0	0	40	51.4
2300	27	0	0	0	3	4	12	5	2	0	1	0	0	0	0	0	41.2	48.2
<b>07-19</b>	<b>1165</b>	<b>4</b>	<b>26</b>	<b>43</b>	<b>88</b>	<b>320</b>	<b>438</b>	<b>179</b>	<b>51</b>	<b>12</b>	<b>3</b>	<b>1</b>	<b>0</b>	<b>0</b>	<b>0</b>	<b>0</b>	<b>38.2</b>	<b>45.5</b>
<b>06-22</b>	<b>1326</b>	<b>5</b>	<b>28</b>	<b>43</b>	<b>95</b>	<b>357</b>	<b>506</b>	<b>212</b>	<b>61</b>	<b>15</b>	<b>3</b>	<b>1</b>	<b>0</b>	<b>0</b>	<b>0</b>	<b>0</b>	<b>38.5</b>	<b>45.8</b>
<b>06-00</b>	<b>1375</b>	<b>5</b>	<b>28</b>	<b>43</b>	<b>102</b>	<b>368</b>	<b>521</b>	<b>221</b>	<b>67</b>	<b>15</b>	<b>4</b>	<b>1</b>	<b>0</b>	<b>0</b>	<b>0</b>	<b>0</b>	<b>38.5</b>	<b>45.9</b>
<b>00-00</b>	<b>1403</b>	<b>5</b>	<b>28</b>	<b>43</b>	<b>102</b>	<b>374</b>	<b>531</b>	<b>224</b>	<b>72</b>	<b>17</b>	<b>5</b>	<b>2</b>	<b>0</b>	<b>0</b>	<b>0</b>	<b>0</b>	<b>38.7</b>	<b>46.1</b>

01 August 2021

Time	Total	Vbin 6 12	Vbin 12 19	Vbin 19 25	Vbin 25 31	Vbin 31 37	Vbin 37 43	Vbin 43 50	Vbin 50 56	Vbin 56 62	Vbin 62 68	Vbin 68 75	Vbin 75 81	Vbin 81 87	Vbin 87 93	Vbin 93 99	Mean	Vpp 85
0000	9	0	0	0	2	0	3	2	2	0	0	0	0	0	0	0	42.2	-
0100	6	0	0	0	0	1	2	2	1	0	0	0	0	0	0	0	42.9	-
0200	2	0	0	0	0	0	1	1	0	0	0	0	0	0	0	0	42.9	-
0300	2	0	0	0	0	0	0	1	0	1	0	0	0	0	0	0	53.2	-
0400	3	0	0	1	0	0	0	1	1	0	0	0	0	0	0	0	39.9	-
0500	1	0	0	0	1	0	0	0	0	0	0	0	0	0	0	0	27.5	-
0600	7	0	0	0	0	2	2	2	0	1	0	0	0	0	0	0	42.6	-
0700	27	0	0	0	1	4	13	5	4	0	0	0	0	0	0	0	42.1	50.1
0800	28	0	0	2	3	6	8	6	2	1	0	0	0	0	0	0	39	48.2
0900	60	0	1	3	1	12	29	10	4	0	0	0	0	0	0	0	39.3	46.4
1000	68	0	0	3	1	22	30	11	0	0	1	0	0	0	0	0	38.4	45
1100	87	0	2	1	3	30	29	19	3	0	0	0	0	0	0	0	38.8	46
1200	116	0	0	1	4	23	57	27	2	1	0	1	0	0	0	0	40.7	45.1
1300	118	0	3	12	12	47	28	13	3	0	0	0	0	0	0	0	35.1	42.5
1400	95	0	2	4	18	39	23	5	3	0	1	0	0	0	0	0	35.1	41.9
1500	78	0	0	2	4	17	39	14	2	0	0	0	0	0	0	0	39.5	45
1600	92	0	1	3	4	20	52	11	1	0	0	0	0	0	0	0	38.4	43.3
1700	79	0	0	0	2	23	38	13	2	1	0	0	0	0	0	0	39.7	45
1800	62	0	0	0	5	14	26	14	2	1	0	0	0	0	0	0	40.2	44.9
1900	64	0	0	0	3	26	24	11	0	0	0	0	0	0	0	0	38.4	43.9
2000	40	0	0	0	8	11	12	9	0	0	0	0	0	0	0	0	37.9	45.9
2100	31	0	0	3	6	10	8	3	1	0	0	0	0	0	0	0	35.6	42.4
2200	23	0	0	0	0	8	5	4	4	2	0	0	0	0	0	0	43.5	53.9
2300	14	0	0	0	1	7	2	3	1	0	0	0	0	0	0	0	39.1	46.2
<b>07-19</b>	<b>910</b>	<b>0</b>	<b>9</b>	<b>31</b>	<b>58</b>	<b>257</b>	<b>372</b>	<b>148</b>	<b>28</b>	<b>4</b>	<b>2</b>	<b>1</b>	<b>0</b>	<b>0</b>	<b>0</b>	<b>0</b>	<b>38.5</b>	<b>44.7</b>
<b>06-22</b>	<b>1052</b>	<b>0</b>	<b>9</b>	<b>34</b>	<b>75</b>	<b>306</b>	<b>418</b>	<b>173</b>	<b>29</b>	<b>5</b>	<b>2</b>	<b>1</b>	<b>0</b>	<b>0</b>	<b>0</b>	<b>0</b>	<b>38.4</b>	<b>44.7</b>
<b>06-00</b>	<b>1089</b>	<b>0</b>	<b>9</b>	<b>34</b>	<b>76</b>	<b>321</b>	<b>425</b>	<b>180</b>	<b>34</b>	<b>7</b>	<b>2</b>	<b>1</b>	<b>0</b>	<b>0</b>	<b>0</b>	<b>0</b>	<b>38.5</b>	<b>44.9</b>
<b>00-00</b>	<b>1112</b>	<b>0</b>	<b>9</b>	<b>35</b>	<b>79</b>	<b>322</b>	<b>431</b>	<b>187</b>	<b>38</b>	<b>8</b>	<b>2</b>	<b>1</b>	<b>0</b>	<b>0</b>	<b>0</b>	<b>0</b>	<b>38.6</b>	<b>45</b>

02 August 2021

Time	Total	Vbin 6 12	Vbin 12 19	Vbin 19 25	Vbin 25 31	Vbin 31 37	Vbin 37 43	Vbin 43 50	Vbin 50 56	Vbin 56 62	Vbin 62 68	Vbin 68 75	Vbin 75 81	Vbin 81 87	Vbin 87 93	Vbin 93 99	Mean	Vpp 85
0000	3	0	0	1	0	0	1	0	1	0	0	0	0	0	0	0	38.3	-
0100	3	0	0	0	2	1	0	0	0	0	0	0	0	0	0	0	30.2	-
0200	4	0	0	0	0	0	0	2	0	1	1	0	0	0	0	0	53.2	-
0300	6	0	0	0	0	1	3	0	2	0	0	0	0	0	0	0	43.2	-
0400	6	0	0	0	0	1	2	1	2	0	0	0	0	0	0	0	44	-
0500	12	0	0	0	1	1	3	5	1	1	0	0	0	0	0	0	44.1	52.8
0600	58	0	1	2	1	10	9	22	11	2	0	0	0	0	0	0	43.2	50.8
0700	155	0	0	2	3	18	70	54	7	1	0	0	0	0	0	0	42	46.8
0800	115	0	0	0	7	16	48	32	11	0	1	0	0	0	0	0	42	47.4
0900	106	0	0	7	24	39	20	11	3	2	0	0	0	0	0	0	35.5	43.6
1000	88	1	4	16	12	26	21	7	1	0	0	0	0	0	0	0	32.7	41.2
1100	113	0	2	0	10	29	45	24	3	0	0	0	0	0	0	0	39	45.6
1200	107	0	0	2	2	17	48	31	4	2	1	0	0	0	0	0	41.3	47.1
1300	100	0	0	2	2	18	51	21	4	1	1	0	0	0	0	0	41.1	45.3
1400	136	0	3	0	12	37	50	24	10	0	0	0	0	0	0	0	38.9	47.3
1500	165	0	1	6	8	33	78	33	4	2	0	0	0	0	0	0	39.6	45.8
1600	214	0	3	4	8	41	79	60	17	2	0	0	0	0	0	0	40.8	48
1700	219	0	1	0	4	39	94	61	15	4	0	1	0	0	0	0	42.2	47.8
1800	133	0	0	1	4	24	47	36	17	4	0	0	0	0	0	0	42.7	50.2
1900	76	0	0	1	2	10	37	18	6	1	1	0	0	0	0	0	41.9	48.3
2000	46	0	0	1	0	5	16	19	4	1	0	0	0	0	0	0	43.3	49.1
2100	28	0	0	0	2	3	10	4	5	2	1	1	0	0	0	0	45.2	57
2200	31	0	0	0	0	5	10	8	4	4	0	0	0	0	0	0	44.6	55.4
2300	8	0	0	0	0	1	5	1	1	0	0	0	0	0	0	0	41.4	-
<b>07-19</b>	<b>1651</b>	<b>1</b>	<b>14</b>	<b>40</b>	<b>96</b>	<b>337</b>	<b>651</b>	<b>394</b>	<b>96</b>	<b>18</b>	<b>3</b>	<b>1</b>	<b>0</b>	<b>0</b>	<b>0</b>	<b>0</b>	<b>40.2</b>	<b>46.9</b>
<b>06-22</b>	<b>1859</b>	<b>1</b>	<b>15</b>	<b>44</b>	<b>101</b>	<b>365</b>	<b>723</b>	<b>457</b>	<b>122</b>	<b>24</b>	<b>5</b>	<b>2</b>	<b>0</b>	<b>0</b>	<b>0</b>	<b>0</b>	<b>40.5</b>	<b>47.3</b>
<b>06-00</b>	<b>1898</b>	<b>1</b>	<b>15</b>	<b>44</b>	<b>101</b>	<b>371</b>	<b>738</b>	<b>466</b>	<b>127</b>	<b>28</b>	<b>5</b>	<b>2</b>	<b>0</b>	<b>0</b>	<b>0</b>	<b>0</b>	<b>40.6</b>	<b>47.3</b>
<b>00-00</b>	<b>1932</b>	<b>1</b>	<b>15</b>	<b>45</b>	<b>104</b>	<b>375</b>	<b>747</b>	<b>474</b>	<b>133</b>	<b>30</b>	<b>6</b>	<b>2</b>	<b>0</b>	<b>0</b>	<b>0</b>	<b>0</b>	<b>40.6</b>	<b>47.4</b>

03 August 2021

Time	Total	Vbin 6 12	Vbin 12 19	Vbin 19 25	Vbin 25 31	Vbin 31 37	Vbin 37 43	Vbin 43 50	Vbin 50 56	Vbin 56 62	Vbin 62 68	Vbin 68 75	Vbin 75 81	Vbin 81 87	Vbin 87 93	Vbin 93 99	Mean	Vpp 85
0000	9	0	0	0	1	2	5	0	0	0	0	1	0	0	0	0	41.4	-
0100	4	0	0	0	0	0	1	0	1	2	0	0	0	0	0	0	52.4	-
0200	4	0	0	0	0	2	2	0	0	0	0	0	0	0	0	0	36.8	-
0300	3	0	0	0	0	0	2	1	0	0	0	0	0	0	0	0	41.5	-
0400	4	0	0	0	0	2	0	1	1	0	0	0	0	0	0	0	41.3	-
0500	17	0	0	0	1	1	4	7	2	1	1	0	0	0	0	0	45.9	56.4
0600	98	2	2	7	9	21	31	20	4	2	0	0	0	0	0	0	37.4	47.8
0700	178	0	0	6	1	27	65	59	19	0	1	0	0	0	0	0	42	48.6
0800	127	0	0	3	2	20	61	33	7	0	1	0	0	0	0	0	41.3	46.3
0900	116	0	1	2	4	27	48	25	7	1	1	0	0	0	0	0	40.5	46.7
1000	101	0	1	2	10	25	40	17	5	1	0	0	0	0	0	0	38.7	45.5
1100	94	0	0	2	4	21	39	18	8	2	0	0	0	0	0	0	40.5	47.5
1200	120	3	6	11	10	23	41	17	7	1	1	0	0	0	0	0	36.4	45.6
1300	119	0	1	0	4	28	42	32	10	1	1	0	0	0	0	0	41.3	47.9
1400	157	0	1	1	12	28	68	34	11	2	0	0	0	0	0	0	40.3	46.5
1500	186	0	1	0	27	56	72	20	8	2	0	0	0	0	0	0	37.9	43.7
1600	192	12	49	65	40	22	3	0	1	0	0	0	0	0	0	0	22.5	30.9
1700	48	25	21	2	0	0	0	0	0	0	0	0	0	0	0	0	13.1	15.7
<b>07-19</b>	<b>1438</b>	<b>40</b>	<b>81</b>	<b>94</b>	<b>114</b>	<b>277</b>	<b>479</b>	<b>255</b>	<b>83</b>	<b>10</b>	<b>5</b>	<b>0</b>	<b>0</b>	<b>0</b>	<b>0</b>	<b>0</b>	<b>36.7</b>	<b>45.9</b>
<b>06-22</b>	<b>1536</b>	<b>42</b>	<b>83</b>	<b>101</b>	<b>123</b>	<b>298</b>	<b>510</b>	<b>275</b>	<b>87</b>	<b>12</b>	<b>5</b>	<b>0</b>	<b>0</b>	<b>0</b>	<b>0</b>	<b>0</b>	<b>36.7</b>	<b>46.1</b>
<b>06-00</b>	<b>1536</b>	<b>42</b>	<b>83</b>	<b>101</b>	<b>123</b>	<b>298</b>	<b>510</b>	<b>275</b>	<b>87</b>	<b>12</b>	<b>5</b>	<b>0</b>	<b>0</b>	<b>0</b>	<b>0</b>	<b>0</b>	<b>36.7</b>	<b>46.1</b>
<b>00-00</b>	<b>1577</b>	<b>42</b>	<b>83</b>	<b>101</b>	<b>125</b>	<b>305</b>	<b>524</b>	<b>284</b>	<b>91</b>	<b>15</b>	<b>6</b>	<b>1</b>	<b>0</b>	<b>0</b>	<b>0</b>	<b>0</b>	<b>36.9</b>	<b>46.2</b>

**Grand Total**

Time	Total	Vbin 6 12	Vbin 12 19	Vbin 19 25	Vbin 25 31	Vbin 31 37	Vbin 37 43	Vbin 43 50	Vbin 50 56	Vbin 56 62	Vbin 62 68	Vbin 68 75	Vbin 75 81	Vbin 81 87	Vbin 87 93	Vbin 93 99	Mean	Vpp 85
--	17659	163	422	501	1153	4372	6836	3157	780	166	49	22	15	14	2	7	38.7	45.7

# K&M TRAFFIC SURVEYS

SITE: COLLIER ST NORTH

LOCATION: ATTACHED TO SIGN

GRID REFERENCE: 51.177723, 0.454130

DIRECTION: SOUTHBOUND    SPEED LIMIT: 50

22 July 2021

Time	Total	Vbin 6 12	Vbin 12 19	Vbin 19 25	Vbin 25 31	Vbin 31 37	Vbin 37 43	Vbin 43 50	Vbin 50 56	Vbin 56 62	Vbin 62 68	Vbin 68 75	Vbin 75 81	Vbin 81 87	Vbin 87 93	Vbin 93 99	Mean	Vpp 85
0000	6	0	0	0	1	4	1	0	0	0	0	0	0	0	0	0	34.2	-
0100	3	0	0	0	0	2	1	0	0	0	0	0	0	0	0	0	35.1	-
0200	1	0	0	0	0	0	1	0	0	0	0	0	0	0	0	0	37.7	-
0300	3	0	0	1	1	1	0	0	0	0	0	0	0	0	0	0	30.4	-
0400	8	0	0	0	2	5	1	0	0	0	0	0	0	0	0	0	33.4	-
0500	27	0	1	1	11	9	5	0	0	0	0	0	0	0	0	0	31.8	38.8
0600	90	0	2	2	21	47	16	2	0	0	0	0	0	0	0	0	33.1	37.8
0700	238	0	3	7	65	125	38	0	0	0	0	0	0	0	0	0	32.8	37.4
0800	195	0	1	3	51	122	18	0	0	0	0	0	0	0	0	0	32.6	36.3
0900	174	0	1	3	72	88	9	0	1	0	0	0	0	0	0	0	31.7	35.5
1000	142	0	0	7	49	69	15	0	2	0	0	0	0	0	0	0	32.2	36.7
1100	164	0	1	8	56	87	12	0	0	0	0	0	0	0	0	0	31.8	35.6
1200	124	0	0	10	36	65	12	0	0	1	0	0	0	0	0	0	32.4	36.8
1300	133	0	0	7	42	72	10	2	0	0	0	0	0	0	0	0	32.1	36.2
1400	146	0	2	6	44	75	19	0	0	0	0	0	0	0	0	0	32.5	36.8
1500	138	0	0	5	40	73	18	2	0	0	0	0	0	0	0	0	32.9	37.3
1600	196	0	1	3	52	115	25	0	0	0	0	0	0	0	0	0	33	37
1700	182	0	1	6	23	116	33	2	0	1	0	0	0	0	0	0	34.1	38.3
1800	115	0	0	3	37	60	12	2	1	0	0	0	0	0	0	0	32.8	36.9
1900	72	0	2	1	31	32	5	1	0	0	0	0	0	0	0	0	31.8	36.1
2000	55	0	0	2	15	29	6	3	0	0	0	0	0	0	0	0	33.2	37.9
2100	40	0	0	1	11	19	9	0	0	0	0	0	0	0	0	0	33.6	38.2
2200	21	0	0	0	6	10	4	1	0	0	0	0	0	0	0	0	33.9	40.1
2300	14	0	0	1	6	4	3	0	0	0	0	0	0	0	0	0	32.4	41.3
<b>07-19</b>	<b>1947</b>	<b>0</b>	<b>10</b>	<b>68</b>	<b>567</b>	<b>1067</b>	<b>221</b>	<b>8</b>	<b>4</b>	<b>2</b>	<b>0</b>	<b>0</b>	<b>0</b>	<b>0</b>	<b>0</b>	<b>0</b>	<b>32.6</b>	<b>36.8</b>
<b>06-22</b>	<b>2204</b>	<b>0</b>	<b>14</b>	<b>74</b>	<b>645</b>	<b>1194</b>	<b>257</b>	<b>14</b>	<b>4</b>	<b>2</b>	<b>0</b>	<b>0</b>	<b>0</b>	<b>0</b>	<b>0</b>	<b>0</b>	<b>32.6</b>	<b>36.9</b>
<b>06-00</b>	<b>2239</b>	<b>0</b>	<b>14</b>	<b>75</b>	<b>657</b>	<b>1208</b>	<b>264</b>	<b>15</b>	<b>4</b>	<b>2</b>	<b>0</b>	<b>0</b>	<b>0</b>	<b>0</b>	<b>0</b>	<b>0</b>	<b>32.6</b>	<b>36.9</b>
<b>00-00</b>	<b>2287</b>	<b>0</b>	<b>15</b>	<b>77</b>	<b>672</b>	<b>1229</b>	<b>273</b>	<b>15</b>	<b>4</b>	<b>2</b>	<b>0</b>	<b>0</b>	<b>0</b>	<b>0</b>	<b>0</b>	<b>0</b>	<b>32.6</b>	<b>36.9</b>

23 July 2021

Time	Total	Vbin 6 12	Vbin 12 19	Vbin 19 25	Vbin 25 31	Vbin 31 37	Vbin 37 43	Vbin 43 50	Vbin 50 56	Vbin 56 62	Vbin 62 68	Vbin 68 75	Vbin 75 81	Vbin 81 87	Vbin 87 93	Vbin 93 99	Mean	Vpp 85
0000	3	0	0	0	0	2	1	0	0	0	0	0	0	0	0	0	36.8	-
0100	4	0	0	0	0	2	1	1	0	0	0	0	0	0	0	0	39.2	-
0200	3	0	0	0	0	2	1	0	0	0	0	0	0	0	0	0	36.6	-
0300	3	0	0	1	0	2	0	0	0	0	0	0	0	0	0	0	30.3	-
0400	9	0	0	0	0	6	3	0	0	0	0	0	0	0	0	0	35.9	-
0500	29	0	0	0	10	15	4	0	0	0	0	0	0	0	0	0	33.2	37.6
0600	101	1	0	1	21	58	18	2	0	0	0	0	0	0	0	0	33.8	38.3
0700	213	0	3	3	64	116	27	0	0	0	0	0	0	0	0	0	32.5	36.9
0800	177	0	0	9	49	90	26	3	0	0	0	0	0	0	0	0	33.1	37.5
0900	152	0	1	3	62	75	10	1	0	0	0	0	0	0	0	0	31.7	36
1000	152	0	0	9	54	71	16	0	2	0	0	0	0	0	0	0	32.1	36.6
1100	140	0	4	11	37	76	12	0	0	0	0	0	0	0	0	0	31.6	36.3
1200	180	0	5	13	53	99	10	0	0	0	0	0	0	0	0	0	31.4	35.4
1300	156	0	3	7	59	76	10	1	0	0	0	0	0	0	0	0	31.5	35.9
1400	141	0	1	4	40	71	20	4	1	0	0	0	0	0	0	0	33.2	38.1
1500	151	0	3	7	43	80	17	1	0	0	0	0	0	0	0	0	32	36.4
1600	174	0	0	4	47	95	27	1	0	0	0	0	0	0	0	0	33.3	37.8
1700	178	0	0	2	38	99	36	3	0	0	0	0	0	0	0	0	34	38.4
1800	105	0	0	8	22	58	12	4	1	0	0	0	0	0	0	0	33.5	38.2
1900	80	0	1	0	28	32	14	4	1	0	0	0	0	0	0	0	33.7	38.8
2000	53	0	1	3	18	22	9	0	0	0	0	0	0	0	0	0	32.3	38.1
2100	31	0	2	2	11	8	7	1	0	0	0	0	0	0	0	0	31.7	38.7
2200	13	0	0	2	1	5	4	1	0	0	0	0	0	0	0	0	34.3	40.7
2300	12	0	0	0	6	5	1	0	0	0	0	0	0	0	0	0	31.7	37.1
<b>07-19</b>	<b>1919</b>	<b>0</b>	<b>20</b>	<b>80</b>	<b>568</b>	<b>1006</b>	<b>223</b>	<b>18</b>	<b>4</b>	<b>0</b>	<b>0</b>	<b>0</b>	<b>0</b>	<b>0</b>	<b>0</b>	<b>0</b>	<b>32.5</b>	<b>36.8</b>
<b>06-22</b>	<b>2184</b>	<b>1</b>	<b>24</b>	<b>86</b>	<b>646</b>	<b>1126</b>	<b>271</b>	<b>25</b>	<b>5</b>	<b>0</b>	<b>0</b>	<b>0</b>	<b>0</b>	<b>0</b>	<b>0</b>	<b>0</b>	<b>32.6</b>	<b>37</b>
<b>06-00</b>	<b>2209</b>	<b>1</b>	<b>24</b>	<b>88</b>	<b>653</b>	<b>1136</b>	<b>276</b>	<b>26</b>	<b>5</b>	<b>0</b>	<b>0</b>	<b>0</b>	<b>0</b>	<b>0</b>	<b>0</b>	<b>0</b>	<b>32.6</b>	<b>37.1</b>
<b>00-00</b>	<b>2260</b>	<b>1</b>	<b>24</b>	<b>89</b>	<b>663</b>	<b>1165</b>	<b>286</b>	<b>27</b>	<b>5</b>	<b>0</b>	<b>0</b>	<b>0</b>	<b>0</b>	<b>0</b>	<b>0</b>	<b>0</b>	<b>32.6</b>	<b>37.1</b>

24 July 2021

Time	Total	Vbin 6 12	Vbin 12 19	Vbin 19 25	Vbin 25 31	Vbin 31 37	Vbin 37 43	Vbin 43 50	Vbin 50 56	Vbin 56 62	Vbin 62 68	Vbin 68 75	Vbin 75 81	Vbin 81 87	Vbin 87 93	Vbin 93 99	Mean	Vpp 85
0000	7	0	0	0	3	3	1	0	0	0	0	0	0	0	0	0	32.8	-
0100	4	0	0	0	1	1	1	1	0	0	0	0	0	0	0	0	36	-
0200	2	0	0	0	1	0	1	0	0	0	0	0	0	0	0	0	35	-
0300	4	0	0	0	1	2	1	0	0	0	0	0	0	0	0	0	33.5	-
0400	8	0	0	0	1	7	0	0	0	0	0	0	0	0	0	0	32.4	-
0500	8	0	0	1	3	3	1	0	0	0	0	0	0	0	0	0	31.7	-
0600	30	0	1	0	13	11	5	0	0	0	0	0	0	0	0	0	32.1	38
0700	67	0	0	3	22	31	9	2	0	0	0	0	0	0	0	0	32.7	37.7
0800	94	0	1	3	30	46	12	2	0	0	0	0	0	0	0	0	32.7	37.4
0900	113	0	0	5	36	56	15	1	0	0	0	0	0	0	0	0	32.5	37.1
1000	129	0	2	5	46	66	10	0	0	0	0	0	0	0	0	0	31.8	36.3
1100	146	0	2	8	42	73	18	3	0	0	0	0	0	0	0	0	32.2	36.9
1200	129	0	3	3	38	67	17	0	1	0	0	0	0	0	0	0	32.6	37
1300	133	0	5	2	42	68	15	1	0	0	0	0	0	0	0	0	32.2	36.7
1400	115	0	0	6	38	55	15	1	0	0	0	0	0	0	0	0	32.8	36.9
1500	88	0	1	3	24	48	12	0	0	0	0	0	0	0	0	0	32.6	37.1
1600	95	0	1	3	30	46	14	1	0	0	0	0	0	0	0	0	32.8	37.3
1700	76	0	3	1	19	38	15	0	0	0	0	0	0	0	0	0	32.9	38.6
1800	64	0	0	1	14	37	9	2	1	0	0	0	0	0	0	0	33.8	39
1900	56	0	0	1	10	32	9	4	0	0	0	0	0	0	0	0	34.4	39
2000	36	0	0	0	14	13	6	2	1	0	0	0	0	0	0	0	34.2	41.4
2100	26	0	0	1	8	13	4	0	0	0	0	0	0	0	0	0	32.3	37.3
2200	19	0	0	0	5	11	3	0	0	0	0	0	0	0	0	0	33	38.1
2300	10	0	0	0	4	4	1	1	0	0	0	0	0	0	0	0	34.1	-
<b>07-19</b>	<b>1249</b>	<b>0</b>	<b>18</b>	<b>43</b>	<b>381</b>	<b>631</b>	<b>161</b>	<b>13</b>	<b>2</b>	<b>0</b>	<b>0</b>	<b>0</b>	<b>0</b>	<b>0</b>	<b>0</b>	<b>0</b>	<b>32.6</b>	<b>37</b>
<b>06-22</b>	<b>1397</b>	<b>0</b>	<b>19</b>	<b>45</b>	<b>426</b>	<b>700</b>	<b>185</b>	<b>19</b>	<b>3</b>	<b>0</b>	<b>0</b>	<b>0</b>	<b>0</b>	<b>0</b>	<b>0</b>	<b>0</b>	<b>32.7</b>	<b>37.2</b>
<b>06-00</b>	<b>1426</b>	<b>0</b>	<b>19</b>	<b>45</b>	<b>435</b>	<b>715</b>	<b>189</b>	<b>20</b>	<b>3</b>	<b>0</b>	<b>0</b>	<b>0</b>	<b>0</b>	<b>0</b>	<b>0</b>	<b>0</b>	<b>32.7</b>	<b>37.2</b>
<b>00-00</b>	<b>1459</b>	<b>0</b>	<b>19</b>	<b>46</b>	<b>445</b>	<b>731</b>	<b>194</b>	<b>21</b>	<b>3</b>	<b>0</b>	<b>0</b>	<b>0</b>	<b>0</b>	<b>0</b>	<b>0</b>	<b>0</b>	<b>32.7</b>	<b>37.2</b>



25 July 2021

Time	Total	Vbin 6 12	Vbin 12 19	Vbin 19 25	Vbin 25 31	Vbin 31 37	Vbin 37 43	Vbin 43 50	Vbin 50 56	Vbin 56 62	Vbin 62 68	Vbin 68 75	Vbin 75 81	Vbin 81 87	Vbin 87 93	Vbin 93 99	Mean	Vpp 85
0000	10	0	0	0	3	5	1	1	0	0	0	0	0	0	0	0	34.3	-
0100	5	0	0	0	0	1	3	1	0	0	0	0	0	0	0	0	39.5	-
0200	6	0	0	0	3	2	0	1	0	0	0	0	0	0	0	0	34.5	-
0300	2	0	0	0	0	0	2	0	0	0	0	0	0	0	0	0	38.6	-
0400	6	0	0	0	1	3	1	0	1	0	0	0	0	0	0	0	36.3	-
0500	5	0	0	0	1	4	0	0	0	0	0	0	0	0	0	0	34.2	-
0600	11	0	0	0	6	3	2	0	0	0	0	0	0	0	0	0	31.8	39
0700	46	0	1	3	10	23	9	0	0	0	0	0	0	0	0	0	33.2	38.9
0800	46	0	0	1	12	24	8	1	0	0	0	0	0	0	0	0	33.7	38.4
0900	71	0	4	5	18	25	16	3	0	0	0	0	0	0	0	0	32.8	39.8
1000	96	0	4	7	28	48	8	1	0	0	0	0	0	0	0	0	30.9	36
1100	109	0	6	2	40	53	8	0	0	0	0	0	0	0	0	0	30.8	35.5
1200	112	0	0	4	42	56	8	2	0	0	0	0	0	0	0	0	32	36.1
1300	82	0	1	4	27	43	7	0	0	0	0	0	0	0	0	0	31.8	36.5
1400	79	0	0	1	19	46	11	2	0	0	0	0	0	0	0	0	33.5	37.6
1500	87	0	3	1	27	48	8	0	0	0	0	0	0	0	0	0	31.8	35.1
1600	72	0	0	3	28	34	7	0	0	0	0	0	0	0	0	0	32	36
1700	75	0	0	4	21	42	7	1	0	0	0	0	0	0	0	0	33	36.5
1800	51	0	0	0	20	20	9	2	0	0	0	0	0	0	0	0	33.4	38.5
1900	34	0	1	0	10	16	5	2	0	0	0	0	0	0	0	0	33.2	38.6
2000	23	0	0	1	6	13	3	0	0	0	0	0	0	0	0	0	32.8	37.2
2100	17	0	0	0	1	11	4	1	0	0	0	0	0	0	0	0	35.9	41
2200	12	0	0	0	4	7	1	0	0	0	0	0	0	0	0	0	33.6	37.1
2300	4	0	0	0	1	1	1	1	0	0	0	0	0	0	0	0	36.7	-
<b>07-19</b>	<b>926</b>	<b>0</b>	<b>19</b>	<b>35</b>	<b>292</b>	<b>462</b>	<b>106</b>	<b>12</b>	<b>0</b>	<b>0</b>	<b>0</b>	<b>0</b>	<b>0</b>	<b>0</b>	<b>0</b>	<b>0</b>	<b>32.2</b>	<b>36.7</b>
<b>06-22</b>	<b>1011</b>	<b>0</b>	<b>20</b>	<b>36</b>	<b>315</b>	<b>505</b>	<b>120</b>	<b>15</b>	<b>0</b>	<b>0</b>	<b>0</b>	<b>0</b>	<b>0</b>	<b>0</b>	<b>0</b>	<b>0</b>	<b>32.3</b>	<b>36.9</b>
<b>06-00</b>	<b>1027</b>	<b>0</b>	<b>20</b>	<b>36</b>	<b>320</b>	<b>513</b>	<b>122</b>	<b>16</b>	<b>0</b>	<b>0</b>	<b>0</b>	<b>0</b>	<b>0</b>	<b>0</b>	<b>0</b>	<b>0</b>	<b>32.4</b>	<b>37</b>
<b>00-00</b>	<b>1061</b>	<b>0</b>	<b>20</b>	<b>36</b>	<b>328</b>	<b>528</b>	<b>129</b>	<b>19</b>	<b>1</b>	<b>0</b>	<b>0</b>	<b>0</b>	<b>0</b>	<b>0</b>	<b>0</b>	<b>0</b>	<b>32.5</b>	<b>37.1</b>

26 July 2021

Time	Total	Vbin 6 12	Vbin 12 19	Vbin 19 25	Vbin 25 31	Vbin 31 37	Vbin 37 43	Vbin 43 50	Vbin 50 56	Vbin 56 62	Vbin 62 68	Vbin 68 75	Vbin 75 81	Vbin 81 87	Vbin 87 93	Vbin 93 99	Mean	Vpp 85
0000	0	0	0	0	0	0	0	0	0	0	0	0	0	0	0	0	-	-
0100	2	0	0	0	1	1	0	0	0	0	0	0	0	0	0	0	34.1	-
0200	4	0	0	0	0	2	2	0	0	0	0	0	0	0	0	0	36	-
0300	1	0	0	0	0	1	0	0	0	0	0	0	0	0	0	0	32.3	-
0400	8	0	0	0	3	3	1	0	0	0	0	0	0	0	0	0	34.1	-
0500	23	0	0	0	3	15	5	0	0	0	0	0	0	0	0	0	34.4	39
0600	79	0	1	0	15	49	11	3	0	0	0	0	0	0	0	0	33.5	38.3
0700	214	0	0	5	74	106	27	2	0	0	0	0	0	0	0	0	32.6	36.9
0800	190	0	6	11	66	84	22	1	0	0	0	0	0	0	0	0	31.4	36.6
0900	124	0	1	5	36	71	11	0	0	0	0	0	0	0	0	0	32.3	36
1000	156	1	3	5	60	72	9	5	1	0	0	0	0	0	0	0	31.7	35.4
1100	106	0	4	2	40	47	12	1	0	0	0	0	0	0	0	0	31.5	36.8
1200	109	0	3	3	33	60	10	0	0	0	0	0	0	0	0	0	32	36.3
1300	113	0	2	4	44	52	9	2	0	0	0	0	0	0	0	0	31.7	36.1
1400	102	0	1	7	31	48	14	1	0	0	0	0	0	0	0	0	31.9	37.3
1500	123	0	2	4	33	67	17	0	0	0	0	0	0	0	0	0	32.6	37.1
1600	171	0	0	5	56	95	15	0	0	0	0	0	0	0	0	0	32.2	36.3
1700	170	0	0	3	41	86	36	4	0	0	0	0	0	0	0	0	34.1	39
1800	107	0	1	3	28	54	17	4	0	0	0	0	0	0	0	0	33.8	38.3
1900	60	0	2	3	19	31	3	1	0	1	0	0	0	0	0	0	32	36.2
2000	42	0	0	0	12	19	11	0	0	0	0	0	0	0	0	0	34	38.7
2100	24	0	0	0	6	11	6	1	0	0	0	0	0	0	0	0	34.4	40.2
2200	18	0	0	0	8	3	5	2	0	0	0	0	0	0	0	0	34.3	42.4
2300	7	0	0	0	2	2	3	0	0	0	0	0	0	0	0	0	35.7	-
<b>07-19</b>	<b>1685</b>	<b>1</b>	<b>23</b>	<b>57</b>	<b>542</b>	<b>842</b>	<b>199</b>	<b>20</b>	<b>1</b>	<b>0</b>	<b>0</b>	<b>0</b>	<b>0</b>	<b>0</b>	<b>0</b>	<b>0</b>	<b>32.3</b>	<b>36.9</b>
<b>06-22</b>	<b>1890</b>	<b>1</b>	<b>26</b>	<b>60</b>	<b>594</b>	<b>952</b>	<b>230</b>	<b>25</b>	<b>1</b>	<b>1</b>	<b>0</b>	<b>0</b>	<b>0</b>	<b>0</b>	<b>0</b>	<b>0</b>	<b>32.4</b>	<b>37</b>
<b>06-00</b>	<b>1915</b>	<b>1</b>	<b>26</b>	<b>60</b>	<b>604</b>	<b>957</b>	<b>238</b>	<b>27</b>	<b>1</b>	<b>1</b>	<b>0</b>	<b>0</b>	<b>0</b>	<b>0</b>	<b>0</b>	<b>0</b>	<b>32.5</b>	<b>37.1</b>
<b>00-00</b>	<b>1953</b>	<b>1</b>	<b>26</b>	<b>60</b>	<b>611</b>	<b>979</b>	<b>246</b>	<b>28</b>	<b>1</b>	<b>1</b>	<b>0</b>	<b>0</b>	<b>0</b>	<b>0</b>	<b>0</b>	<b>0</b>	<b>32.5</b>	<b>37.1</b>

27 July 2021

Time	Total	Vbin 6 12	Vbin 12 19	Vbin 19 25	Vbin 25 31	Vbin 31 37	Vbin 37 43	Vbin 43 50	Vbin 50 56	Vbin 56 62	Vbin 62 68	Vbin 68 75	Vbin 75 81	Vbin 81 87	Vbin 87 93	Vbin 93 99	Mean	Vpp 85
0000	1	0	0	0	1	0	0	0	0	0	0	0	0	0	0	0	26.7	-
0100	3	0	0	0	1	1	1	0	0	0	0	0	0	0	0	0	34	-
0200	1	0	0	0	0	1	0	0	0	0	0	0	0	0	0	0	34.2	-
0300	0	0	0	0	0	0	0	0	0	0	0	0	0	0	0	0	-	-
0400	7	0	0	0	3	2	2	0	0	0	0	0	0	0	0	0	33.3	-
0500	25	0	0	0	8	13	4	0	0	0	0	0	0	0	0	0	33.5	38.6
0600	69	0	0	0	28	29	9	2	0	1	0	0	0	0	0	0	33.3	38.1
0700	224	0	0	1	70	122	29	2	0	0	0	0	0	0	0	0	33	37
0800	203	0	1	9	78	102	12	1	0	0	0	0	0	0	0	0	31.7	35.6
0900	119	0	2	8	48	54	7	0	0	0	0	0	0	0	0	0	30.8	35.2
1000	120	0	2	5	35	62	15	1	0	0	0	0	0	0	0	0	32.3	37.1
1100	108	0	2	8	41	47	8	1	1	0	0	0	0	0	0	0	31.4	36.4
1200	105	0	0	2	40	55	8	0	0	0	0	0	0	0	0	0	31.8	35.3
1300	109	0	0	4	37	59	9	0	0	0	0	0	0	0	0	0	32.2	36.5
1400	124	0	0	9	40	66	9	0	0	0	0	0	0	0	0	0	31.6	35.2
1500	107	0	0	2	40	55	10	0	0	0	0	0	0	0	0	0	31.9	36
1600	174	0	0	5	51	98	19	1	0	0	0	0	0	0	0	0	32.8	36.8
1700	184	2	4	5	51	91	29	2	0	0	0	0	0	0	0	0	32.5	37.8
1800	109	1	2	2	30	52	18	4	0	0	0	0	0	0	0	0	33.3	38.9
1900	82	0	0	2	21	45	13	1	0	0	0	0	0	0	0	0	33.6	37.5
2000	50	0	0	1	14	22	10	3	0	0	0	0	0	0	0	0	34.1	38.9
2100	26	0	0	1	8	11	4	2	0	0	0	0	0	0	0	0	33.5	40.5
2200	13	0	0	0	7	3	3	0	0	0	0	0	0	0	0	0	32.8	40.3
2300	9	0	0	0	1	7	1	0	0	0	0	0	0	0	0	0	34.7	-
<b>07-19</b>	<b>1686</b>	<b>3</b>	<b>13</b>	<b>60</b>	<b>561</b>	<b>863</b>	<b>173</b>	<b>12</b>	<b>1</b>	<b>0</b>	<b>0</b>	<b>0</b>	<b>0</b>	<b>0</b>	<b>0</b>	<b>0</b>	<b>32.2</b>	<b>36.5</b>
<b>06-22</b>	<b>1913</b>	<b>3</b>	<b>13</b>	<b>64</b>	<b>632</b>	<b>970</b>	<b>209</b>	<b>20</b>	<b>1</b>	<b>1</b>	<b>0</b>	<b>0</b>	<b>0</b>	<b>0</b>	<b>0</b>	<b>0</b>	<b>32.4</b>	<b>36.8</b>
<b>06-00</b>	<b>1935</b>	<b>3</b>	<b>13</b>	<b>64</b>	<b>640</b>	<b>980</b>	<b>213</b>	<b>20</b>	<b>1</b>	<b>1</b>	<b>0</b>	<b>0</b>	<b>0</b>	<b>0</b>	<b>0</b>	<b>0</b>	<b>32.4</b>	<b>36.8</b>
<b>00-00</b>	<b>1972</b>	<b>3</b>	<b>13</b>	<b>64</b>	<b>653</b>	<b>997</b>	<b>220</b>	<b>20</b>	<b>1</b>	<b>1</b>	<b>0</b>	<b>0</b>	<b>0</b>	<b>0</b>	<b>0</b>	<b>0</b>	<b>32.4</b>	<b>36.9</b>

28 July 2021

Time	Total	Vbin 6 12	Vbin 12 19	Vbin 19 25	Vbin 25 31	Vbin 31 37	Vbin 37 43	Vbin 43 50	Vbin 50 56	Vbin 56 62	Vbin 62 68	Vbin 68 75	Vbin 75 81	Vbin 81 87	Vbin 87 93	Vbin 93 99	Mean	Vpp 85
0000	6	0	0	0	3	1	2	0	0	0	0	0	0	0	0	0	32.5	-
0100	1	0	0	0	0	1	0	0	0	0	0	0	0	0	0	0	36.6	-
0200	1	0	0	0	0	1	0	0	0	0	0	0	0	0	0	0	32.5	-
0300	1	0	0	0	0	1	0	0	0	0	0	0	0	0	0	0	37	-
0400	3	0	0	0	0	2	1	0	0	0	0	0	0	0	0	0	34.7	-
0500	27	0	0	0	6	16	5	0	0	0	0	0	0	0	0	0	34.4	38.7
0600	81	0	0	3	26	44	8	0	0	0	0	0	0	0	0	0	32.5	36.4
0700	239	0	2	3	76	130	27	0	1	0	0	0	0	0	0	0	32.6	36.4
0800	187	0	2	8	57	97	22	1	0	0	0	0	0	0	0	0	32.3	36.5
0900	124	0	6	8	35	61	11	3	0	0	0	0	0	0	0	0	31.4	36.2
1000	151	0	2	14	53	68	14	0	0	0	0	0	0	0	0	0	31.3	35.8
1100	134	1	2	5	65	50	11	0	0	0	0	0	0	0	0	0	31	36
1200	113	0	1	6	43	54	9	0	0	0	0	0	0	0	0	0	31.5	36.1
1300	103	0	0	0	33	53	16	1	0	0	0	0	0	0	0	0	33.5	38.1
1400	123	0	5	3	38	62	15	0	0	0	0	0	0	0	0	0	32.1	36.9
1500	117	0	2	0	26	73	14	2	0	0	0	0	0	0	0	0	33.5	37.2
1600	165	0	2	3	40	91	29	0	0	0	0	0	0	0	0	0	33.1	37.7
1700	192	0	0	1	43	107	36	5	0	0	0	0	0	0	0	0	34.2	38.1
1800	126	0	1	5	23	69	27	1	0	0	0	0	0	0	0	0	33.9	38.5
1900	88	0	3	0	19	49	13	1	1	2	0	0	0	0	0	0	34.4	38.3
2000	52	0	1	2	8	26	14	1	0	0	0	0	0	0	0	0	34	38.9
2100	22	0	0	0	6	13	3	0	0	0	0	0	0	0	0	0	33.6	37.8
2200	16	0	0	1	4	6	3	1	1	0	0	0	0	0	0	0	35.3	43.5
2300	8	0	0	0	2	6	0	0	0	0	0	0	0	0	0	0	33.1	-
<b>07-19</b>	<b>1774</b>	<b>1</b>	<b>25</b>	<b>56</b>	<b>532</b>	<b>915</b>	<b>231</b>	<b>13</b>	<b>1</b>	<b>0</b>	<b>0</b>	<b>0</b>	<b>0</b>	<b>0</b>	<b>0</b>	<b>0</b>	<b>32.6</b>	<b>37</b>
<b>06-22</b>	<b>2017</b>	<b>1</b>	<b>29</b>	<b>61</b>	<b>591</b>	<b>1047</b>	<b>269</b>	<b>15</b>	<b>2</b>	<b>2</b>	<b>0</b>	<b>0</b>	<b>0</b>	<b>0</b>	<b>0</b>	<b>0</b>	<b>32.7</b>	<b>37.1</b>
<b>06-00</b>	<b>2041</b>	<b>1</b>	<b>29</b>	<b>62</b>	<b>597</b>	<b>1059</b>	<b>272</b>	<b>16</b>	<b>3</b>	<b>2</b>	<b>0</b>	<b>0</b>	<b>0</b>	<b>0</b>	<b>0</b>	<b>0</b>	<b>32.7</b>	<b>37.2</b>
<b>00-00</b>	<b>2080</b>	<b>1</b>	<b>29</b>	<b>62</b>	<b>606</b>	<b>1081</b>	<b>280</b>	<b>16</b>	<b>3</b>	<b>2</b>	<b>0</b>	<b>0</b>	<b>0</b>	<b>0</b>	<b>0</b>	<b>0</b>	<b>32.7</b>	<b>37.2</b>

**Grand Total**

Time	Total	Vbin 6 12	Vbin 12 19	Vbin 19 25	Vbin 25 31	Vbin 31 37	Vbin 37 43	Vbin 43 50	Vbin 50 56	Vbin 56 62	Vbin 62 68	Vbin 68 75	Vbin 75 81	Vbin 81 87	Vbin 87 93	Vbin 93 99	Mean	Vpp 85
--	13072	6	146	434	3978	6710	1628	146	18	6	0	0	0	0	0	0	32.6	37

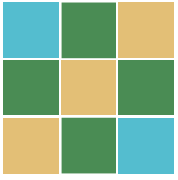

COTSWOLD  
TRANSPORT  
PLANNING

## Appendix C

Proposed Access Arrangements

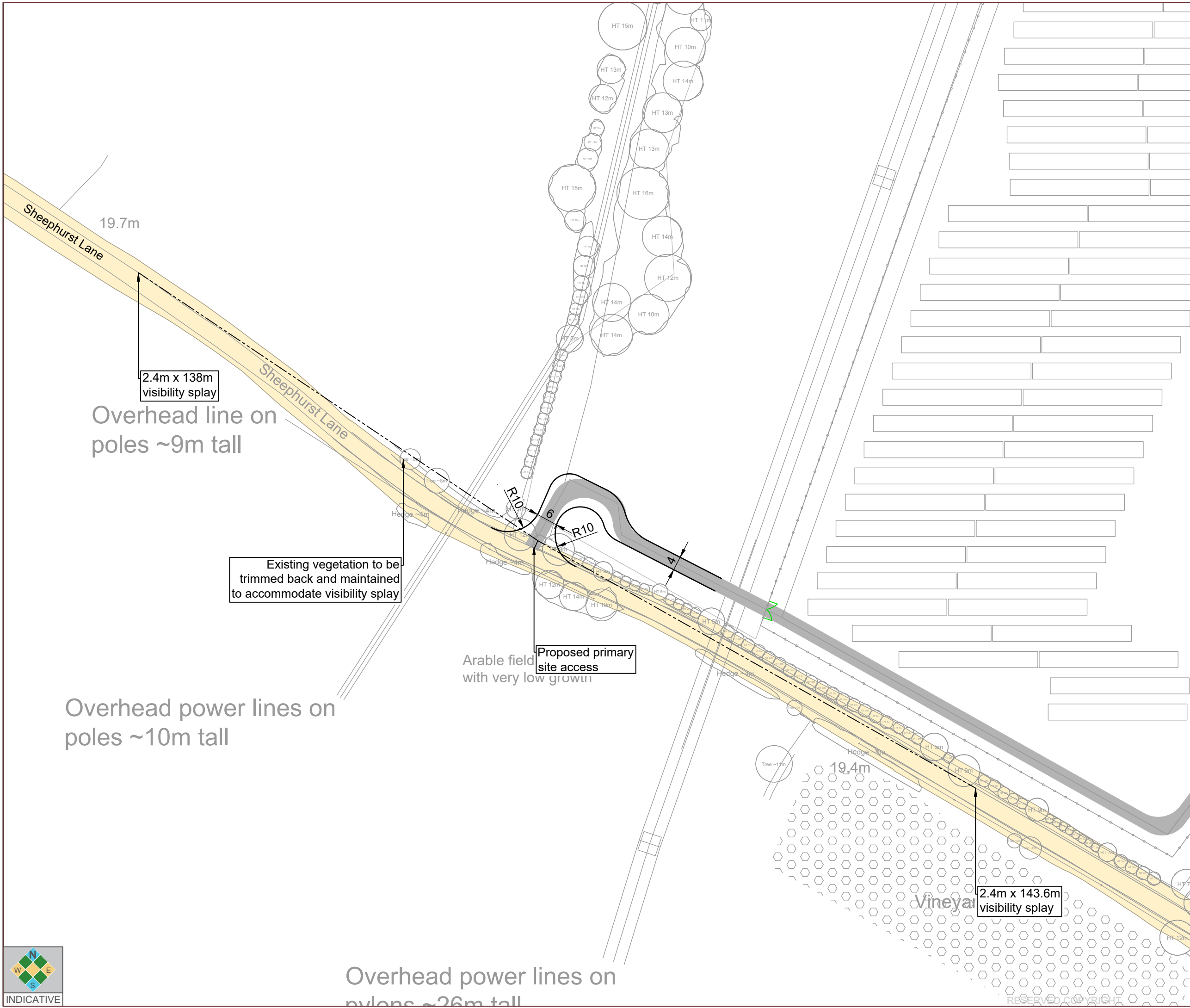

**Notes:**

1. Do not scale from this drawing. All dimensions are in metres, unless stated otherwise.
2. This drawing is based on the Architects layout received from Origin Power Services Limited on 14 February 2022.
3. Ordnance Survey, (c) Crown Copyright 2020. All rights reserved. Licence number 100022432.

**Key:**

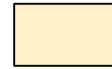
 Extent of adopted highway maintainable at public expense

Rev	Date	Details	Drawn by	Checked by
A	21/02/22	Site layout proposals amended	KPS	KPS



CLIENT: **Statkraft**

PROJECT: **Sheepwash Solar Energy Farm Marden Kent**

TITLE: **Sheephurst Lane Primary Site Access**

STATUS: **INFORMATION**

SCALE @ A3:	DATE:	DRAWN:	CHECKED:	APPROVED:
1:1000	07/01/22	KPS	CE	CE
JOB NO:	DRAWING NO:	REVISION:		
21-0354	SK01	A		



RECEIVED COPYRIGHT

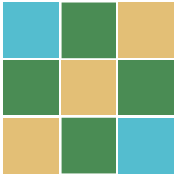

COTSWOLD  
TRANSPORT  
PLANNING

## Appendix D

### Swept Path Analysis



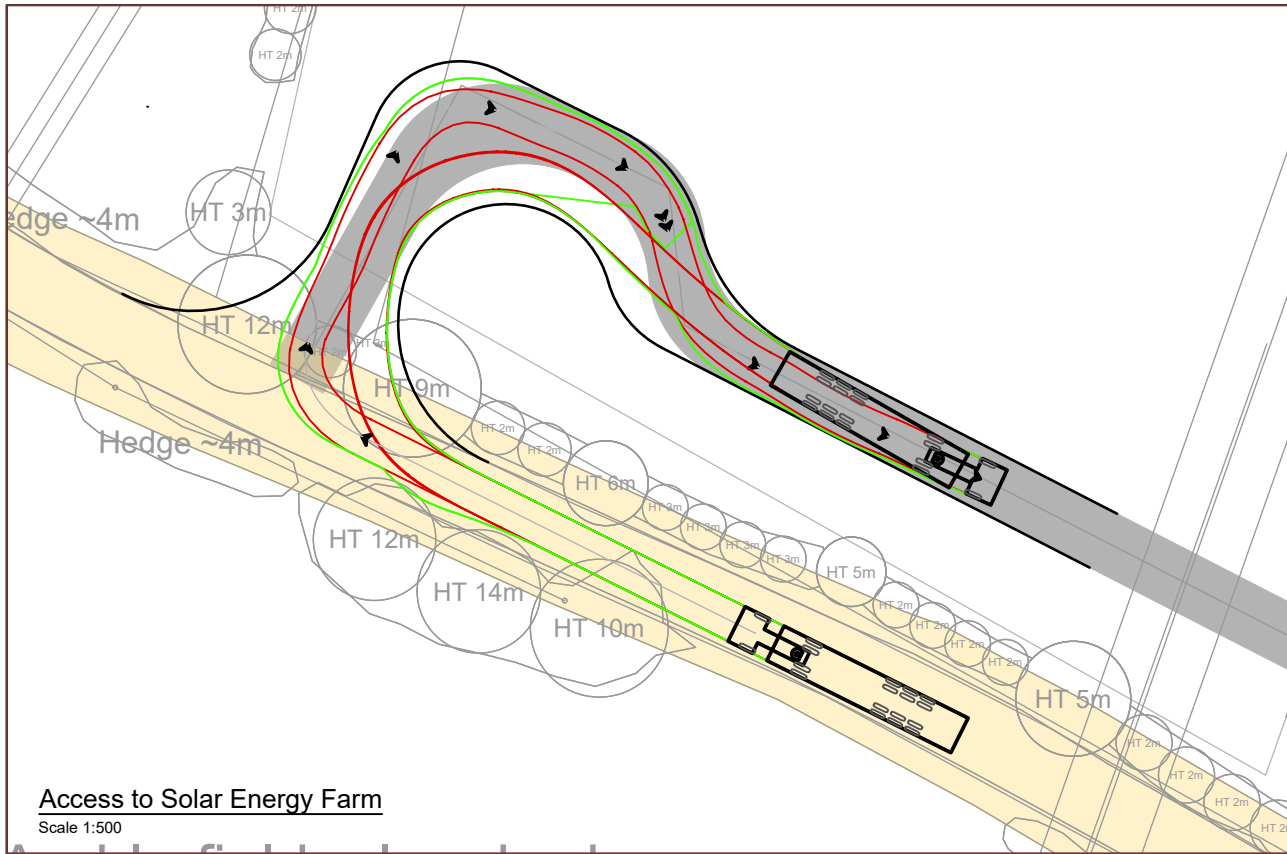

**Access to Solar Energy Farm**

Scale 1:500

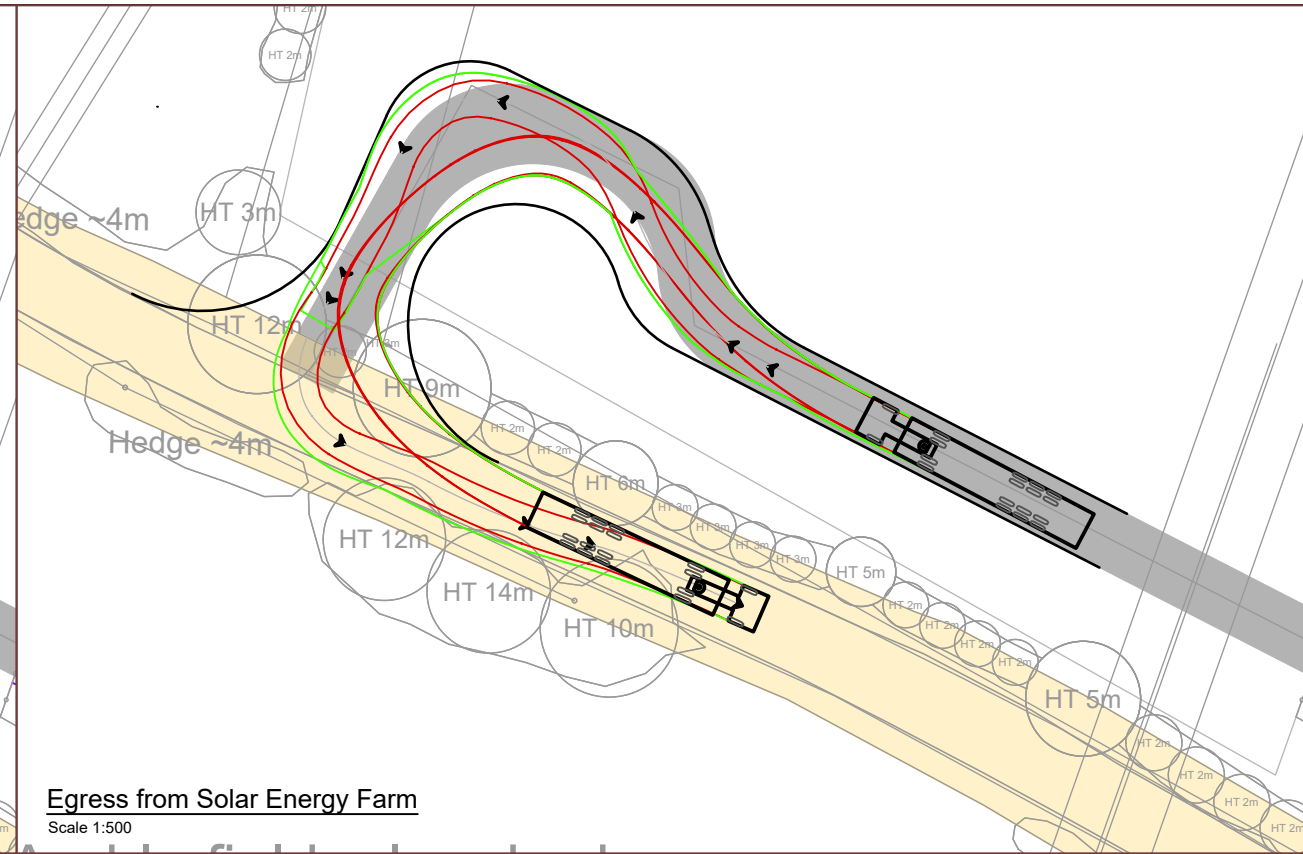

**Egress from Solar Energy Farm**

Scale 1:500

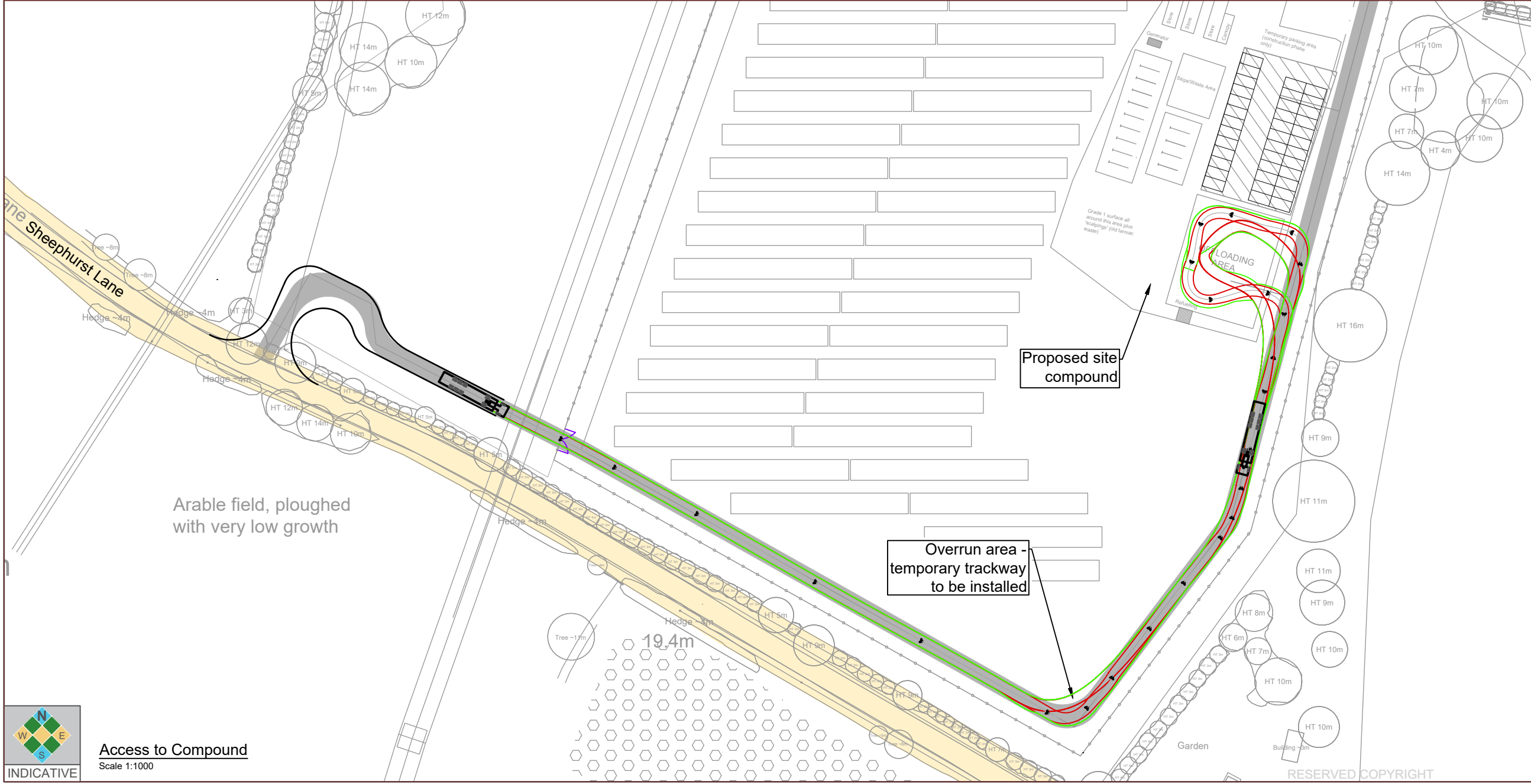

**Access to Compound**

Scale 1:1000



**Notes:**

1. Do not scale from this drawing. All dimensions are in metres, unless stated otherwise.
2. This drawing is based on the Architects layout received from Origin Power Services Limited on 14 February 2022.
3. Ordnance Survey, (c) Crown Copyright 2020. All rights reserved. Licence number 100022432.

**Key:**

Extent of adopted highway maintainable at public expense

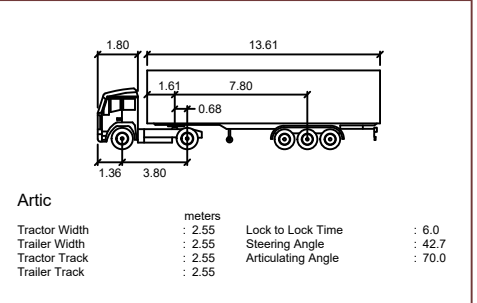

Rev	Date	Details	Drawn by	Checked by
B	18.08.22	Site compound and swept path analysis amended	KPS	CE
A	21/02/22	Site layout proposals amended	KPS	KPS



CLIENT: **Statkraft**

PROJECT: **Sheepwash Solar Energy Farm  
Marden  
Kent**

TITLE: **Sheephurst Lane  
Primary Site Access  
Swept Path Analysis**

STATUS: **INFORMATION**

SCALE @ A3:	DATE:	DRAWN:	CHECKED:	APPROVED:
As shown	07/01/22	KPS	CE	CE
JOB NO:	DRAWING NO:	REVISION:		
21-0354	SP01	B		

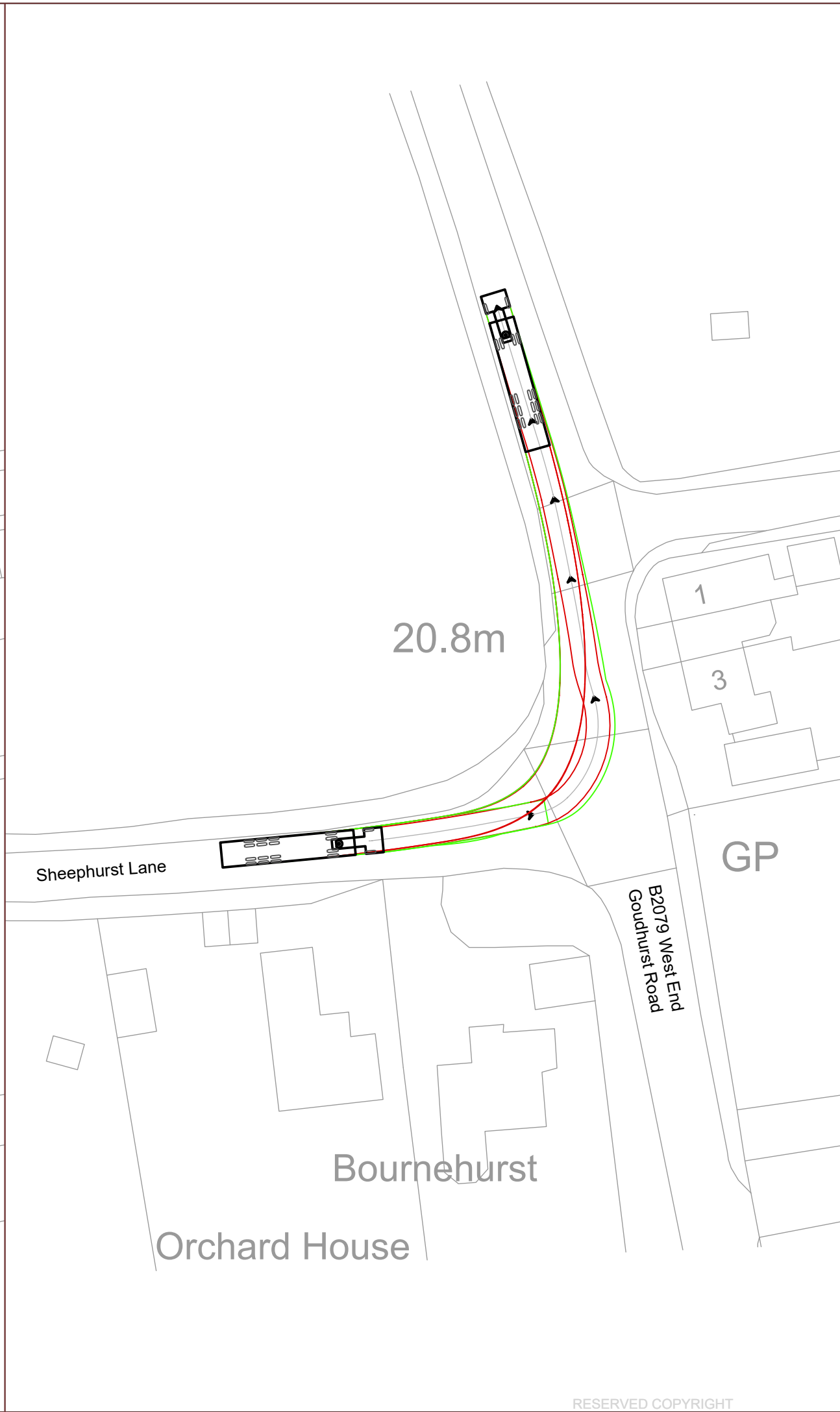
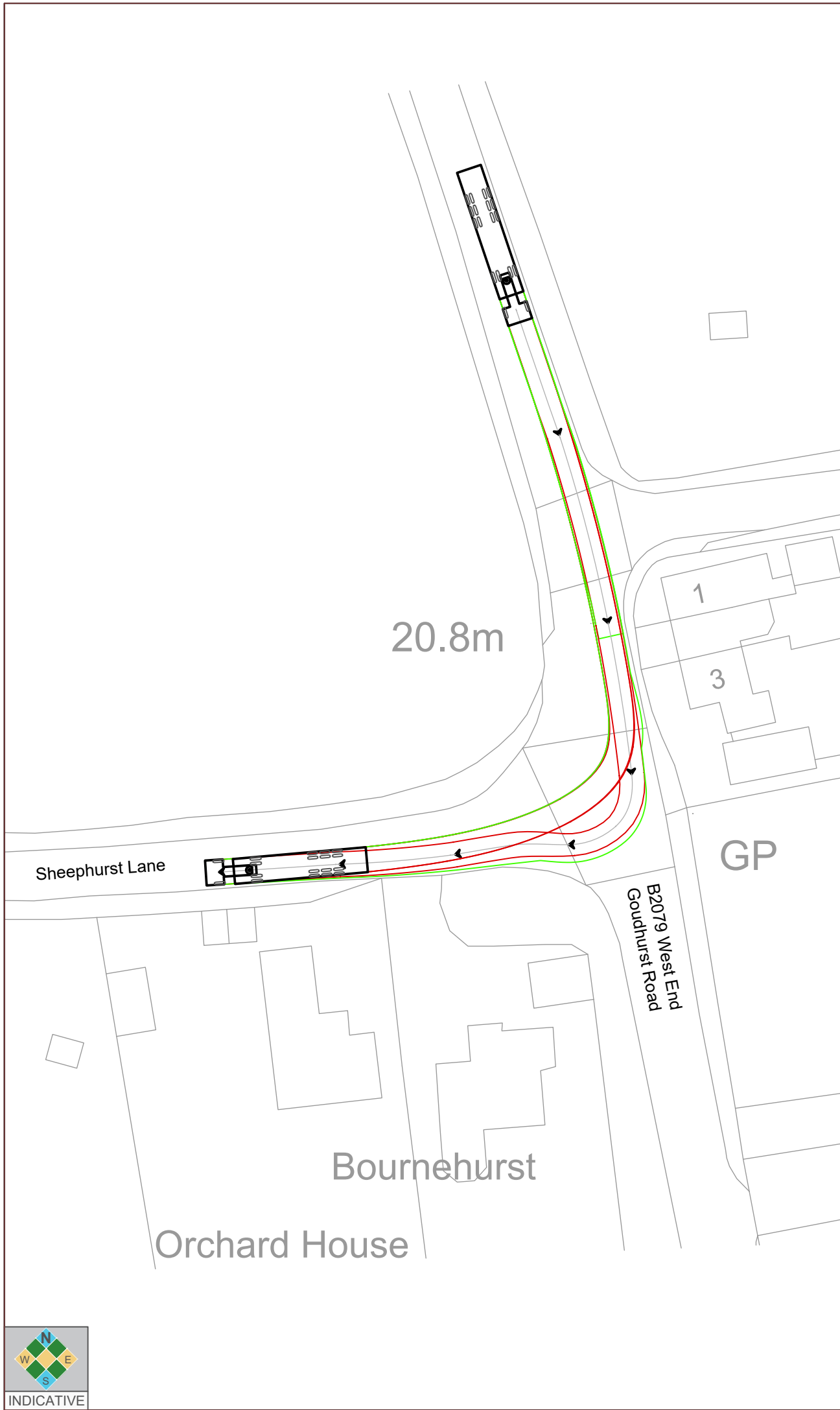

**Notes:**

1. Do not scale from this drawing. All dimensions are in metres, unless stated otherwise.
2. This drawing is based on the Architects layout received from Origin Power Services Limited on 23 December 2021.
3. Ordnance Survey, (c) Crown Copyright 2020. All rights reserved. Licence number 100022432.

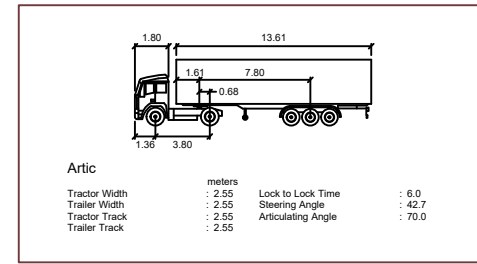

Rev	Date	Details	Drawn by	Checked by
A	18.08.22	Swept path analysis amended	KPS	CE



CLIENT: **Statkraft**

PROJECT: **Sheepwash Solar Energy Farm  
Marden  
Kent**

TITLE: **Plain Road / B2079 West End  
Goudhurst Road / Sheephurst Lane  
Swept Path Analysis**

STATUS: **INFORMATION**

SCALE @ A3:	DATE:	DRAWN:	CHECKED:	APPROVED:
1:500	07/01/22	KPS	CE	CE
JOB NO:	DRAWING NO:	REVISION:		
21-0354	SP02	A		



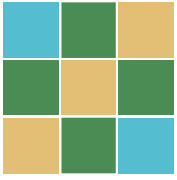

COTSWOLD  
TRANSPORT  
PLANNING

## Appendix E

Site Compound Layout

**Notes:**

1. Do not scale from this drawing. All dimensions are in metres, unless stated otherwise.
2. This drawing is based on the Architects layout received from Origin Power Services Limited on 14 February 2022.
3. Ordnance Survey, (c) Crown Copyright 2020. All rights reserved. Licence number 100022432.

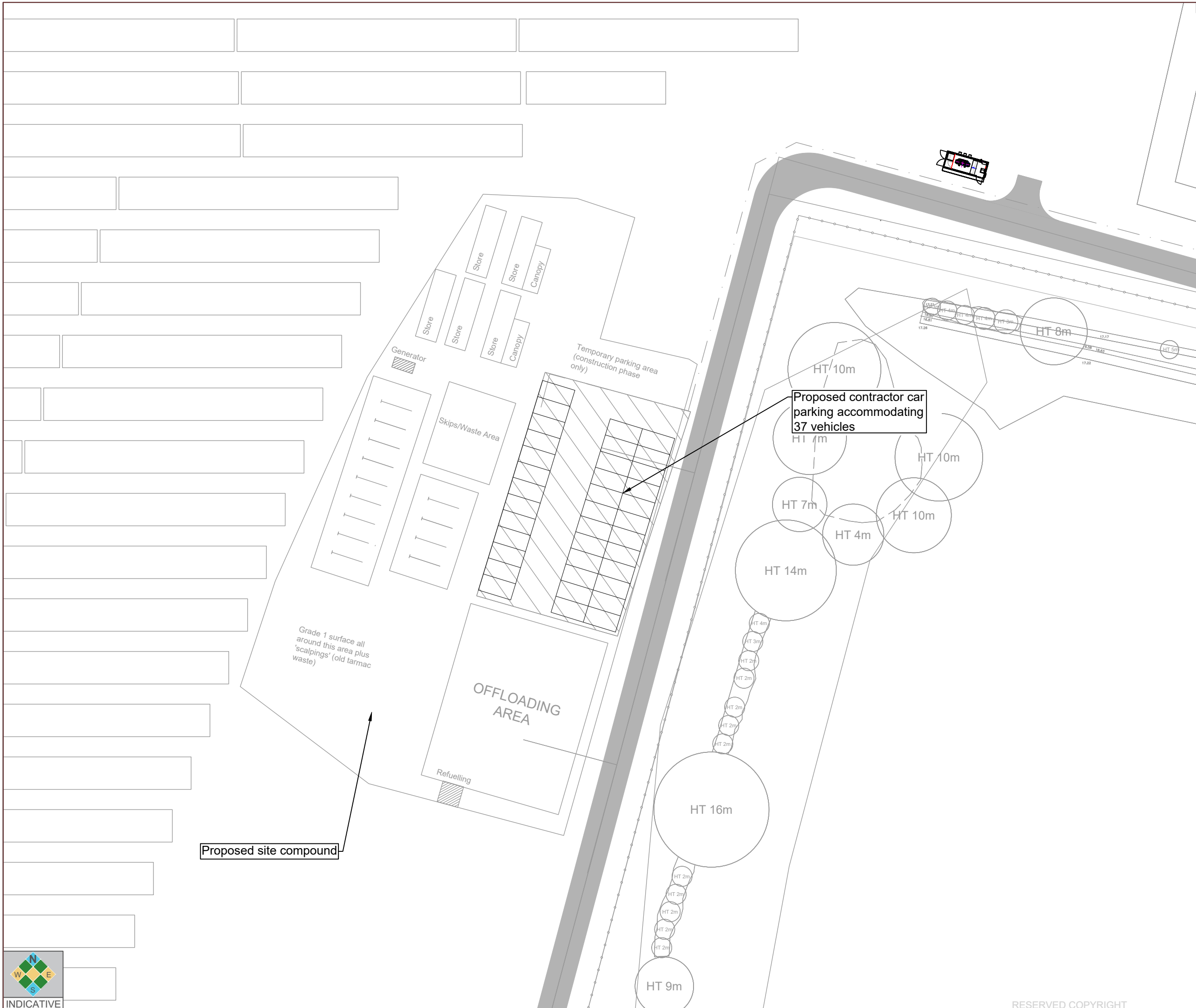

Rev	Date	Details	Drawn by	Checked by



CLIENT: **Statkraft**

PROJECT: **Sheepwash Solar Energy Farm Marden Kent**

TITLE: **Shephurst Lane Proposed Site Compound**

STATUS: **INFORMATION**

SCALE @ A3: 1:500	DATE: 18/08/22	DRAWN: KPS	CHECKED: CE	APPROVED: CE
JOB NO: 21-0354	DRAWING NO: SK04	REVISION: -		

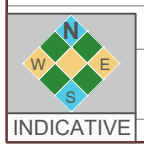

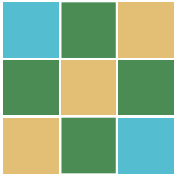

COTSWOLD  
TRANSPORT  
PLANNING

## Appendix F

Junction Visibility Splays





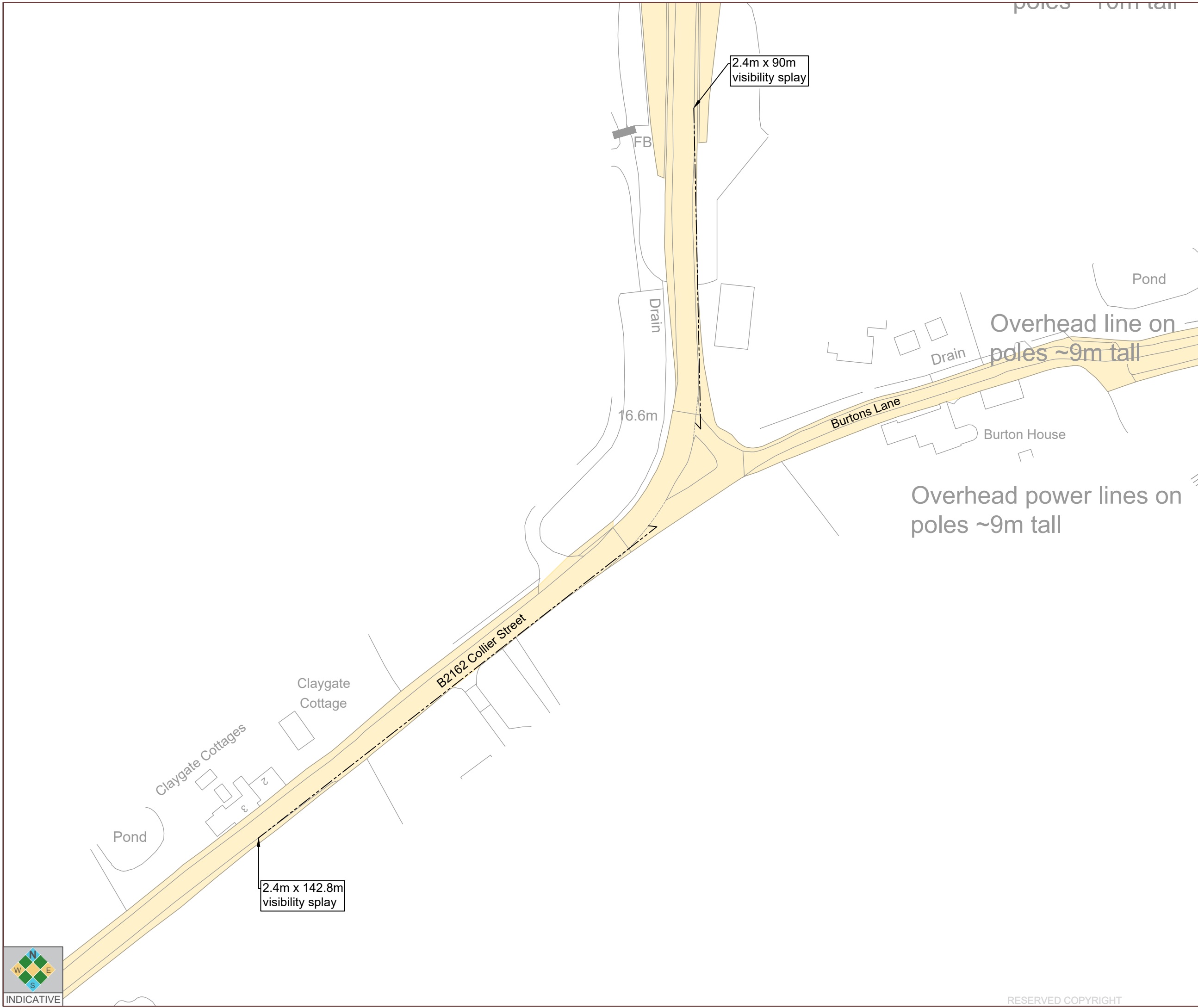

**Notes:**

1. Do not scale from this drawing. All dimensions are in metres, unless stated otherwise.
2. This drawing is based on the Architects layout received from Origin Power Services Limited on 23 December 2021.
3. Ordnance Survey, (c) Crown Copyright 2020. All rights reserved. Licence number 100022432.

**Key:**

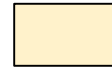
 Extent of adopted highway maintainable at public expense

Rev	Date	Details	Drawn by	Checked by



CLIENT: **Statkraft**

PROJECT: **Sheepwash Solar Energy Farm  
Marden  
Kent**

TITLE: **Collier Street / Burtons Lane  
Junction  
Visibility Splays**

STATUS: **INFORMATION**

SCALE @ A3: 1:1000	DATE: 07/01/22	DRAWN: KPS	CHECKED: CE	APPROVED: CE
-----------------------	-------------------	---------------	----------------	-----------------

JOB NO: Junction	DRAWING NO: SK02	REVISION: -
---------------------	---------------------	----------------



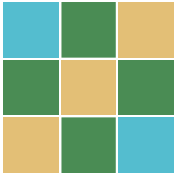

COTSWOLD  
TRANSPORT  
PLANNING

## Appendix G

Construction Traffic Routing

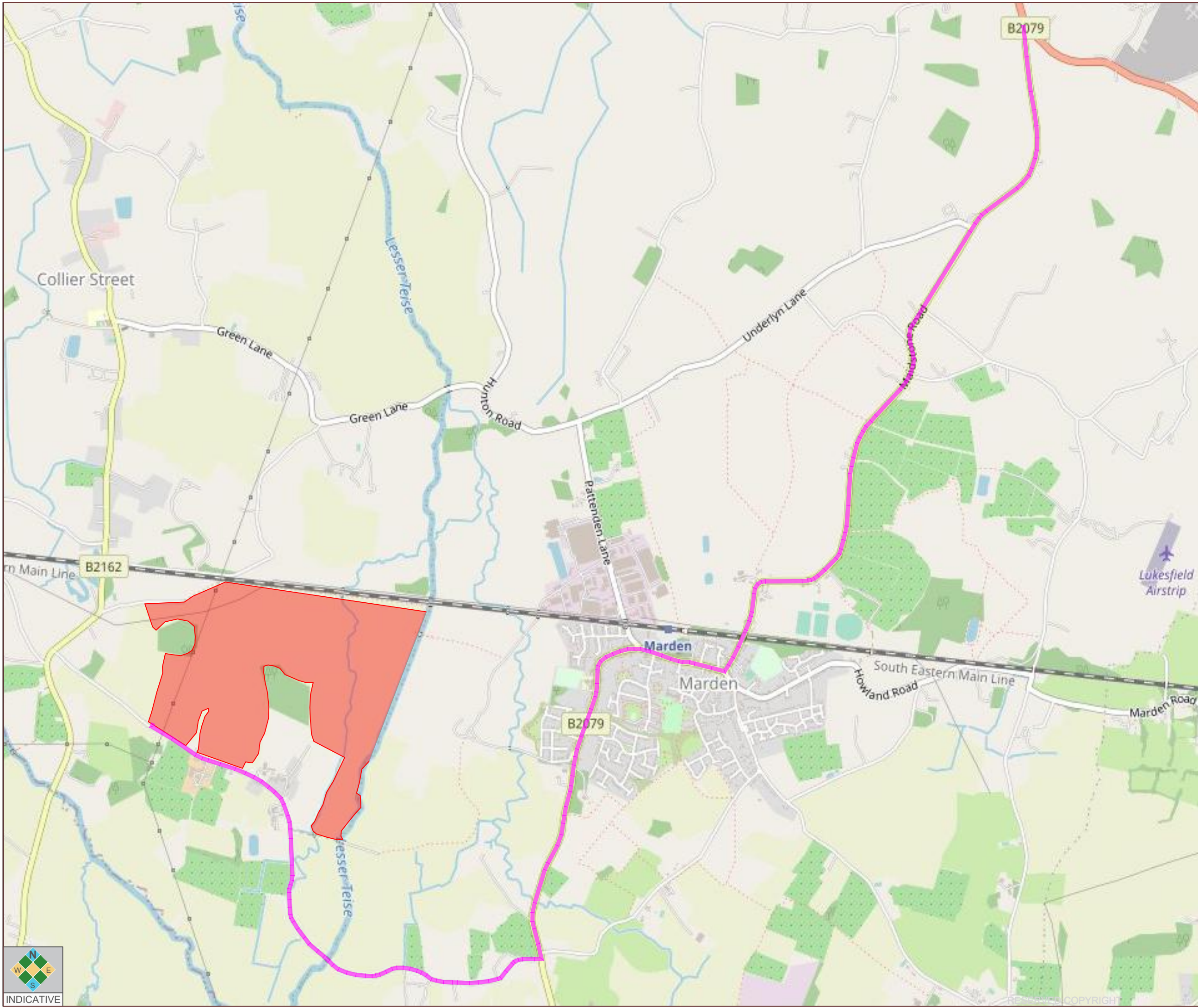

**Notes:**

1. Do not scale from this drawing. All dimensions are in metres, unless stated otherwise.
2. Ordnance Survey, (c) Crown Copyright 2020. All rights reserved. Licence number 100022432.

**Key:**

- Site Location (approximate)
- Proposed Construction Traffic Route

Rev	Date	Details	Drawn by	Checked by
A	18.08.22	Construction traffic routing amended	KPS	CE



**COTSWOLD  
TRANSPORT  
PLANNING**

CLIENT: **Statkraft**

PROJECT: **Sheepwash Solar Energy Farm  
Marden  
Kent**

TITLE: **Construction Traffic Routing**

STATUS: **INFORMATION**

SCALE @ A3: N.T.S.	DATE: 07/01/22	DRAWN: KPS	CHECKED: CE	APPROVED: CE
JOB NO: 21-0354	DRAWING NO: SK03	REVISION: A		

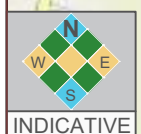

INDICATIVE

ORDNANCE SURVEY COPYRIGHT