



**STRATKRAFT LTD**

**SWANSEA NORTH GREENER GRID PARK**

**FLOOD CONSEQUENCE ASSESSMENT**

**FEBRUARY 2023**

**DATE ISSUED: FEBRUARY 2023**  
**JOB NUMBER: ST19905**  
**REPORT NUMBER: 0011**  
**VERSION: V2.0**  
**STATUS FINAL**

**STATKRAFT LTD**

**SWANSEA NORTH GREENER GRID PARK**

**FLOOD CONSEQUENCE ASSESSMENT**

**FEBRUARY 2023**

**PREPARED BY:**

J Allen Flood Risk Consultant



B Griffiths Senior Environmental Scientist



**REVIEWED BY**

E Keegan Associate Director



**APPROVED BY:**

A Burnham Service Area Director – Civil and Structural Engineering



*This report has been prepared by Wardell Armstrong LLP with all reasonable skill, care and diligence, within the terms of the Contract with the Client. The report is confidential to the Client and Wardell Armstrong LLP accepts no responsibility of whatever nature to third parties to whom this report may be made known.*

*No part of this document may be reproduced without the prior written approval of Wardell Armstrong LLP.*



## CONTENTS

1	INTRODUCTION.....	1
2	SITE SETTING.....	5
3	DEVELOPMENT PROPOSALS.....	7
4	FLOOD CONSEQUENCE ASSESSMENT.....	8
5	POST-DEVELOPMENT FLOOD RISK ASSESSMENT.....	13
6	FLOOD RISK MITIGATION MEASURES AND RESIDUAL RISK.....	15
7	DRAINAGE STRATEGY.....	16
8	CONCLUSIONS.....	21

## APPENDICES

Appendix 1	Utilities Report
Appendix 2	Greenfield Runoff Rates
Appendix 3	Attenuation Estimates

## DRAWINGS

20221205	Site Layout
230116	Topographical Survey
ST19905-019	Indicative Surface Water Management

## 1 INTRODUCTION

### 1.1 General

1.1.1 Wardell Armstrong LLP (WA) has been commissioned by Statkraft UK Ltd (the Client) to prepare a Flood Consequence Assessment (FCA) for a proposed 'Greener Grid Park' development at the existing Swansea North Substation.

1.1.2 This assessment has been carried out in accordance with guidance set out in the Welsh Government Technical Advice Note 15 'Development and Flood Risk' (TAN15).

### 1.2 Methodology

1.2.1 The methodology for this FCA has comprised a desktop study and liaison with the supplemented by liaison with the Lead Local Flood Authority (City and Council of Swansea Council) and Natural Resources Wales (NRW).

1.2.2 In accordance with TAN15, the following has been carried out in preparing this assessment:

- an assessment of the consequences of flooding to the development from a range of sources;
- an assessment of the consequences of flooding from the proposed development site; and
- consideration of recommendations for the management of the identified consequences.

1.2.3 In carrying out this assessment, reference has been made to relevant plans and documents, including:

- Swansea City and County Preliminary Flood Risk Assessment 2011;
- Swansea City Flood Risk Management Plan 2015.

### 1.3 Planning Policy Wales

1.3.1 Technical Advice Note 15 (TAN15) "Development and Flood Risk" was published in July 2004 by the Welsh Assembly Government (WAG) and supplements the policy set out in Planning Policy Wales (PPW), 2016 (Edition 9). It gives guidance to planning authorities in Wales on how to respond on flood risk grounds to development proposals. TAN15 expects planning authorities to apply a risk-based approach to development planning and control through a Sequential Test involving location justification, type of development and flooding consequences.

1.3.2 In October 2017, the Welsh Government published the latest TAN15 Development Advice Maps (DAMs) which show areas potentially at risk from flood events of a 0.1% annual probability for river, tidal or coastal areas (ie 1 in 1,000 year). The Development Advice Maps divide the land area of Wales into three flood risk zones. These are denoted A, B and C, with Zone C further sub-divided into Zones C1 and C2. The Flood Zones are described in further detail in Table 1 below.

<b>Table 1: TAN15 Development Advice Map Flood Zones</b>		
<b>Zone</b>	<b>Description</b>	<b>Use within the precautionary framework</b>
A	Considered to be at little or no risk of fluvial or tidal/coastal flooding.	Used to indicate that Justification Test is not applicable and no need to consider flood risk further.
B	Areas known to have been flooded in the past evidenced by sedimentary deposits.	Used as part of a precautionary approach to indicate where site levels should be checked against the extreme (0.1%) flood level. If site levels are greater than the flood levels used to define adjacent extreme flood outline there is no need to consider flood risk further.
C	Based on Environment Agency extreme flood outline, equal to or greater than 0.1% (river, tidal or coastal).	Used to indicate that flooding issues should be considered as an integral part of decision making by the application of the Justification Test including assessment of consequences.
C1	Areas of the floodplain which are developed and served by significant infrastructure, including flood defences.	Used to indicate that development can take place subject to application of Justification Test, including acceptability of consequences.
C2	Areas of the floodplain without significant flood defence infrastructure.	Used to indicate that only less vulnerable development should be considered subject to application of Justification Test, including acceptability of consequences. Emergency services and highly vulnerable development should not be considered.

1.3.3 Section 5 of TAN15 categorises development according to its vulnerability to flooding. There are three categories: emergency services; highly vulnerable development; and less vulnerable development. All residential premises and vulnerable industrial developments are categorised as highly vulnerable developments. Commercial, retail, and general industrial development are categorised as less vulnerable developments.

#### 1.4 Flood Risk Vulnerability

1.4.1 It is considered that the proposed development is classified as a ‘*Less Vulnerable*’ development (‘*General industrial, employment, commercial and retail development*’) based on Section 5 of TAN15.

#### 1.5 Justification Test

1.5.1 The Justification Test aims to direct new development away from Zone C and towards land in Zone A (or otherwise Zone B). A new ‘*Less Vulnerable*’ development would only be permitted within Zone C if it is deemed to be justified in that location. A development would only be justified if it demonstrates that:

- I. its location in zone C is necessary to assist, or be part of, a local authority regeneration initiative or a local authority strategy required to sustain an existing settlement; or
- II. its location in zone C is necessary to contribute to key employment objectives supported by the local authority, and other key partners, to sustain an existing settlement or region;

AND

- III. it concurs with the aims of PPW and meets the definition of previously developed land; and
- IV. the potential consequences of a flooding event for the development have been considered and are found to be acceptable.

1.5.2 As the site is located within Flood Zone A the Justification Test is passed.

#### ***Swansea Council Preliminary Flood Risk Assessment***

1.5.3 A Preliminary Flood Risk Assessment (PFRA) is a high-level screening exercise to identify areas where there is significant flood risk from local sources, namely ordinary watercourses, surface water runoff and groundwater. It does not directly consider flooding from main rivers or from sewers. PFRAs have been produced by Lead Local Flood Authorities (LLFAs) to fulfil statutory requirements in the Flood Risk Regulations 2009. In this case the LLFA is Swansea Council and an updated PFRA was published in 2017<sup>1</sup>.

---

<sup>1</sup>City and County of Swansea (2011) Preliminary Flood Risk Assessment  
ST19905/2.0/FINAL  
FEBRUARY 2023

---

***Swansea Council Local Flood Risk Management Strategy***

- 1.5.4 The Local Flood Risk Management Strategy (LFRMS) report sets out the principles, objectives, and measures for the management of local flood risk by Swansea Council as the LLFA (where “local flood risk” is defined as “*surface water runoff, ground water and ordinary watercourses and included any lake, pond or other body of water that feeds from an ordinary watercourse*”). The report<sup>2</sup> was published in February 2013.

---

<sup>2</sup> Gwynedd Council (2013) *Gwynedd Local Flood Risk Management Strategy*  
ST19905/2.0/FINAL  
FEBRUARY 2023

## 2 SITE SETTING

### 2.1 Site Description and Location

2.1.1 A summary of the site and its characteristics is provided in Table 2.

<b>Table 2: Site Location Summary</b>	
<b>Site Name</b>	Swansea North Greener Grid Park
<b>Site Address</b>	Land off Rhydhpany Road, Morriston, Swansea SA5 7NN
<b>Site Area (ha)</b>	3
<b>National Grid Reference</b>	SN 65299 01149
<b>Existing Land Use</b>	Agricultural Land
<b>Proposed Land Use</b>	Greener Grid Park
<b>Lead Local Flood Authority</b>	The City and County of Swansea
<b>Local Planning Authority</b>	The City and County of Swansea
<b>Sewerage Undertaker</b>	Welsh Water

2.1.2 The site is located in south-west Wales approximately 2.8km to the north-west of Morriston. The Greener Grid Park site is approximately 3ha in size and is currently undeveloped agricultural land. The site is bounded to the north, south, east, and west by further agricultural land. The 299MW Abergelli Gas Fired Power Station has a Development Consent Order (DCO) application approved and is proposed to cut through the southeast corner of the site at a southwest to northeast orientation.

1.1.1 The site is located at National Grid Reference NGR E 265322, N 201125, the location of the site is shown on Figure 1. As shown on Drawing No. 230116 'Topographical Survey' the site is generally sloped to the southwest with ground levels ranging from approximately 84mAOD to 89mAOD. The site existing access is located adjacent to the southern boundary of the site.

### 2.2 Existing Watercourses and Waterbodies

2.2.1 The Afon Llan (Main River) is located approximately 400m to the south-east of the site. The river flows south-west passed the site and discharges into the Nant y Gors approximately 1.3km further to the south-east.

2.2.2 There are no watercourses within the site, with the closest being an unnamed ordinary watercourse adjacent to the western boundary of the site, which flows northwards to the north-western corner of the site, before extending westwards away from the site.



2.2.3 There is also a field drain approximately 30m beyond the north-eastern corner of the site, flowing north-westwards away from the site. It is assumed to provide drainage for the adjacent access track.

2.2.4 Drawing No. 230116 Topographical Survey shows a ditch adjacent to the southern boundary of the site. It is assumed that this is a field drain discharging to the ordinary watercourse adjacent to the south-western corner of the site. A section of the ditch becomes culverted to facilitate the sites existing access.

## 2.3 Ground Conditions

2.3.1 The online British Geological Survey (BGS)<sup>3</sup> 'Geology of Britain Viewer' shows that the site is underlain by mudstone, sandstone and conglomerate of the Grovesend Formation. The online DEFRA 'Magic' mapping classifies this as a 'Secondary A' aquifer, defined as *'permeable layers capable of supporting water supplies at a local rather than strategic scale, and in some cases forming an important source of base flow to rivers'*.

2.3.2 BGS mapping also shows that the site is underlain by superficial deposits of till, classified as an 'Unproductive' aquifer, defined as *'areas comprised of rocks that have negligible significance for water supply or baseflow to rivers, lakes and wetlands'*.

1.1.2 The Cranfield Soil and Agrifood Institute 'Soilscapes' mapping<sup>4</sup> classifies the underlying soils as *'slowly permeable seasonally wet acid peaty'* soils.

## 2.4 Existing Drainage

2.4.1 The utilities report provided by Promap in December 2022, and included in Appendix 1, does not identify any public sewers within the site area. Due to the rural nature of the site, it is also assumed that there are no private sewers. All agricultural land will, therefore, drain naturally by a combination of infiltration, transpiration, and evaporation. Surface water runoff exceeding the rate of infiltration will generally flow overland towards the ordinary watercourse adjacent to the western boundary of the site.

---

<sup>3</sup> BRITISH GEOLOGICAL SURVEY 'Geology of Britain Viewer' Available at: <http://mapapps.bgs.ac.uk/geologyofbritain/home.html>

<sup>4</sup> CRANFIELD SOIL AND AGRIFOOD INSTITUTE 'Soilscapes' Available at: <https://www.landis.org.uk/soilscapes/>

### 3 DEVELOPMENT PROPOSALS

#### 3.1 Description of the Proposed Development

3.1.1 It is proposed to construct a compound area with three energy management systems, along with a series of, inverter units, transformers, and associated structures. The access for the site is shared with a proposed access track for the approved Abergelli Power Station and, therefore, will not be considered as part of this FRA.

#### 3.2 Development Advice Map

3.2.1 The 'Development Advice Map' for flood risk obtained from the Natural Resources Wales website (see Figure 2) shows that the site is located within Zone A, described in TAN15 as an area '*considered to be at little or no risk of fluvial or tidal/coastal flooding*'.

3.2.2 The nearest area of Flood Zone C2 associated with the Afon Llan is located approximately 350m to the south-east of the site. Flood Zone C2 is defined as '*areas of flood plain without significant flood defence infrastructure*'.

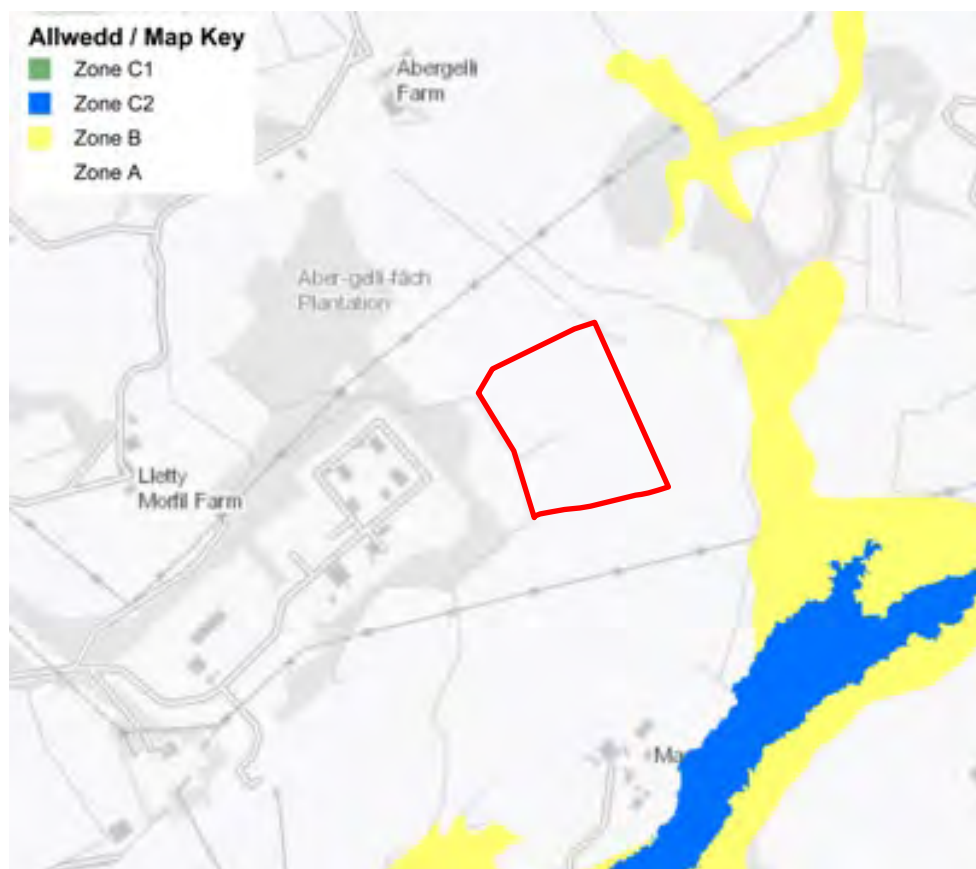

Figure 1. NRW Development Advice Map

## 4 FLOOD CONSEQUENCE ASSESSMENT

### 4.1 Historical Flooding

4.1.1 The Natural Resources Wales 'Recorded Flood Extents' mapping does not show any recorded flooding events in the vicinity of the site.

4.1.2 The Swansea Council Flood Risk Management Plan refers to the location of historic flooding events in Swansea. Mapping shows that the nearest location with records of past flooding is approximately 750m to the northwest of the site in Waun y Garn-wen. There is no information regarding the cause of flooding in this instance.

4.1.3 The Swansea Council Preliminary Flood Risk Assessment also includes mapping locating areas across Swansea with 'Areas above the Flood Risk Threshold' for groundwater flooding. There are no areas within the site or its vicinity that are categorised as above the flood risk threshold.

### 4.2 Consequences of Flooding to the Development

4.2.1 Flooding can occur from a range of sources including, but not limited to rivers, tidal waters and the sea, surface water runoff, groundwater, sewers and drains, and artificial sources such as canals and reservoirs. The presence of a potential flooding source does not, however, necessarily translate into a high risk of flooding. Following the source-pathway-receptor approach, flooding can only affect the site (receptor) if there is a pathway from the identified sources.

### 4.3 Flooding Consequences to the Proposed Development

#### ***Fluvial Sources***

4.3.1 The Natural Resources Wales fluvial flood map assigns Low, Medium and High risk to areas susceptible to fluvial flooding. These are defined as follows:

- Very Low – each year, these areas have a chance of flooding of less than 1 in 1000 years (<0.1%);
- Low – each year, these areas have a chance of flooding of between 1 in 1000 years (0.1%) and 1 in 100 years (1%);
- Medium – each year, these areas have a chance of flooding of between 1 in 100 years (1%) and 1 in 30 years (3.3%);
- High – each year, these areas have a chance of flooding of greater than 1 in 30 years (>3.3%).

4.3.2 As shown in Figure 3, the site is located wholly within an area of Very Low risk. The nearest area of High risk of flooding from rivers is located approximately 350m to the south-west of the site.

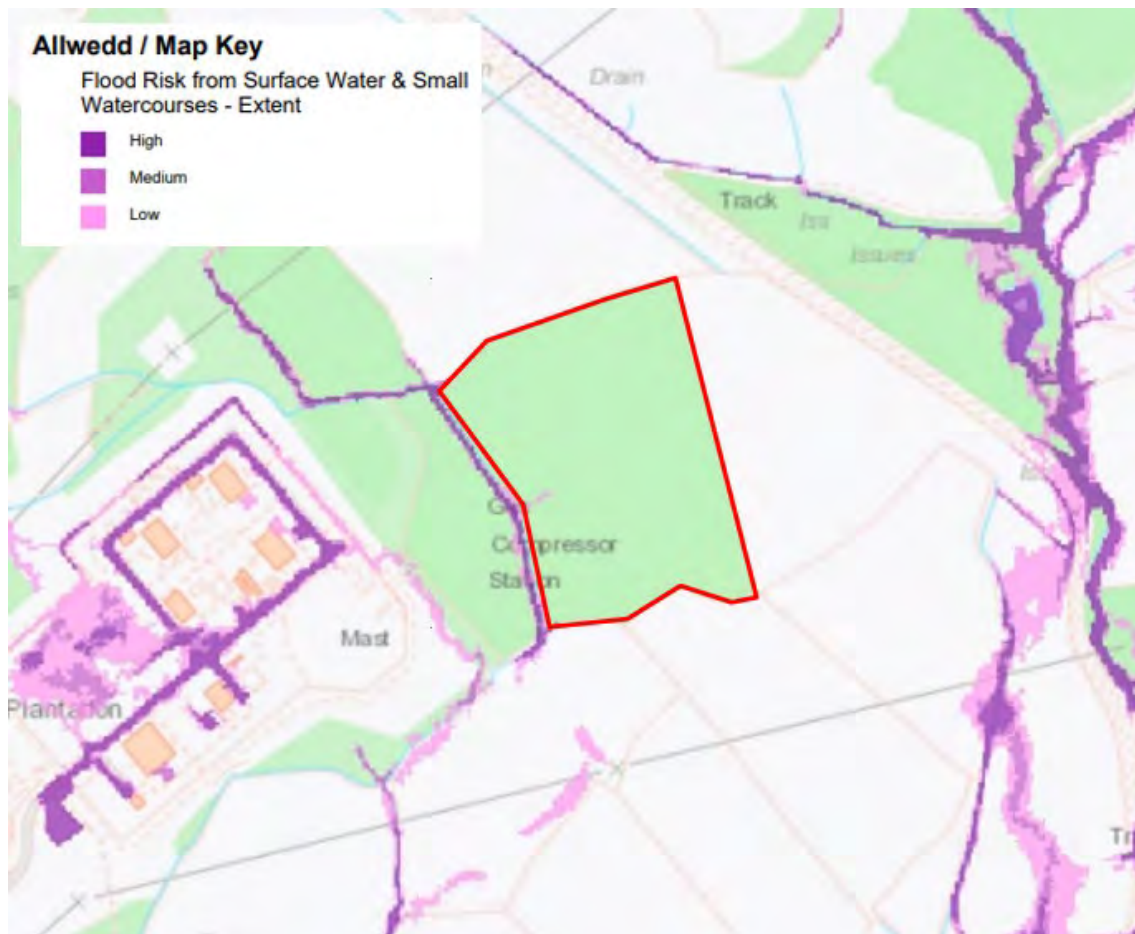

**Figure 2. NRW Fluvial Flood Risk Map**

#### 4.4 Surface Water Flooding

4.4.1 Natural Resources Wales 'Surface Water and Small Watercourses' mapping (Figure 4), shows that the majority of the site area is located in an area at Very Low risk of flooding from surface water (with a less than 0.1% annual probability of flooding).

4.4.2 The watercourse adjacent to the western boundary is shown to be at an increased risk of flooding and a small section of land at a Low risk of flooding extends into the site, with an annual probability of flooding of between 1 in 100 years and 1 in 1000 years (ie 1% - 0.1%). This land is coincident with an area of low-lying ground and does not pose a risk of flooding to the wider site.



**Figure 3. NRW Flood Risk from Surface Water and Small Watercourses Map**

#### 4.5 Groundwater Flooding

4.5.1 Groundwater flooding can occur when prolonged rainfall causes the groundwater table to rise above ground level. Groundwater flooding can occur at the same time as flooding from other sources such as overland flow.

4.5.2 The Preliminary Flood Risk Assessment, states that historically, there are no records of any significant groundwater flooding, and no areas 'Above the Flood Risk Threshold' in the City and County of Swansea.

4.5.3 As the site is adjacent to an ordinary watercourse to the west, there is a possibility that lower areas of the site will be in continuity with the water table.

#### 4.6 Sewer Flooding

4.6.1 Flooding could occur on site from localised, high intensity storms of a relatively short duration that might exceed the capacity of the local drainage network.

4.6.2 The utilities report included as Appendix 1 does not identify any public sewers within the site area. Due to the rural nature of the site, it is also assumed that there are no private sewers. It is considered, therefore, that the site is not at risk of sewer flooding.

#### 4.7 Artificial Sources

4.7.1 Artificial sources of flooding include reservoirs, canals and any other impounded water body which is elevated above the site. Flooding can occur when the impounding structures such as dams and embankments fail, when culverts become blocked, or during extreme rainfall events when the waterbodies overflow.

4.7.2 The NRW 'Flood Risk from Reservoirs' map shows that the site is located outside of an area of an area at risk of flooding from reservoirs.

4.7.3 The site currently comprises a culverted section of the southern watercourse at the site access. However, the culvert area is covered by the proposed 'Abergelli DCO shared access' as shown in Drawing No. 20221205 'Site Layout'. Under the DCO application it is assumed that the culvert will be adequately designed to convey flow beneath the road, and that any risk to the surrounding area will be mitigated.

4.7.4 There are no canals or other impounded water bodies in the vicinity of the site.

#### 4.8 Potential Sources of Flooding

4.8.1 Table 3 summarises the flood consequences to the proposed development. The risk is described in further detail in this section.

<b>Table 3: Summary of Flood Consequences to the Site</b>			
<b>Type</b>	<b>Source</b>	<b>Pathway</b>	<b>Risk</b>
Fluvial Flooding (Rivers)	<b>Y</b>	<b>N</b>	-
Tidal Flooding	<b>N</b>	-	-
Surface Water Runoff	<b>Y</b>	<b>Y</b>	<b>Very Low</b>
Groundwater Flooding	<b>Y</b>	<b>Y</b>	<b>Low</b>
Sewer/Drain Flooding	<b>N</b>	-	-
Artificial Flooding	<b>N</b>	-	-

4.8.2 The potential sources of flooding with a pathway to the site are, therefore, surface water and groundwater flooding.

### ***Groundwater Flood Risk***

Based on the information available, there is a pathway for groundwater to enter the site through the underlying geology. However, proposed ground levels at the site suggest this is unlikely, at approximately 86.5mAOD whereas the watercourse is at approximately 83mAOD. Therefore, the risk of groundwater flooding at the site is considered to be **LOW**.

### ***Surface Water Flood Risk***

- 4.8.3 Based on Figure 4 the pathway for surface water flooding into the site is located adjacent to the west boundary. The pathway is associated with the ordinary watercourse to the west of the site. The local topography would convey surface water flooding to the west away from the development, into the ordinary watercourse. Therefore, the risk of surface water flooding to the site is considered to be **VERY LOW**.

## 5 POST-DEVELOPMENT FLOOD RISK ASSESSMENT

5.1.1 New development can pose a risk of flooding to neighbouring properties and areas downstream of the site, often as a result of an increase in impermeable area which has the effect of increasing the rate and volume of surface water runoff. In addition, climate change can be expected to cause an increase in rainfall intensity and surface water runoff over the lifetime of the development.

5.1.2 Flood risk can also be increased as a result of new development if the development reduces the floodplain storage area or alters flood flow paths, ultimately displacing flood water and resulting in an increased risk to the surrounding area.

### 5.2 Fluvial Flooding

5.2.1 The proposed development is located wholly within Flood Zone A, remote from any significant watercourses. There will, therefore, be no loss of floodplain storage or impact on any fluvial flood flow routes as a result of the proposed development.

### 5.3 Surface Water Flooding (Pluvial Flooding)

5.3.1 Overland flow routes will not be impeded or diverted as a result of the proposed development and it is considered, therefore, that the risk of surface water flooding will not increase as a result of the proposed development.

### 5.4 Surface Water Runoff

5.4.1 The existing agricultural land is considered to be wholly permeable, with any surface water runoff dispersing naturally by infiltration, evaporation or uptake by vegetation or flowing overland following the local topography to enter the ordinary watercourse to the west of the development.

5.4.2 The proposed development will comprise a hardstanding platform, and a semi permeable porous gravel surface, along with battery units, inverter units, transformers and other associated structures. The total impermeable area post-development will be approximately 1.18ha. The rate and volume of surface water runoff could, therefore, potentially increase as a result of the proposed development.

### 5.5 Climate Change

5.5.1 It is also necessary to take account of climate change for the lifetime of the development when assessing future flood risk. NRW and UK Government guidance provides predictions of anticipated changes to peak river flows and rainfall intensity for consideration on new developments. In assessing fluvial flooding from the proposed development, the climate change predictions for peak rainfall intensity for



the lifetime of the development need to be taken into account. An increase of intensity and frequency of rainfall is likely to raise river levels and increase the likelihood of a river overtopping its banks.

5.5.2 An increase in rainfall intensity could also increase the rate and volume of surface water generated during a storm event and this should be considered when assessing surface water flood risk. The Welsh Government 'Flood Consequences Assessment: Climate Change Allowances' report states that non-residential development should have an assumed lifespan of 75 years and, based on Table 2 of the report (reproduced as Table 4 below), a 40% increase in rainfall intensity should be considered.

<b>Table 4: Peak Rainfall Intensity Allowances</b>			
<b>Time Period</b>	<b>'2020s' (2015 – 2039)</b>	<b>'2050s' 2040 – 2069</b>	<b>'2080s' 2070 – 2115</b>
Peak Rainfall Intensity – Upper End	10%	20%	40%
Peak Rainfall Intensity – Central	5%	10%	20%

5.5.3 It is considered, therefore, that the risk of surface water flooding could increase as a result of the proposed development and that mitigation measures are required.

## **6 FLOOD RISK MITIGATION MEASURES AND RESIDUAL RISK**

### **6.1 Surface Water Management**

6.1.1 The assessment has identified that the development proposals and climate change could result in increased surface water runoff rates and volumes, which could impact areas downstream of the site.

6.1.2 To reduce the potential increase in flood risk posed by the proposed development, it is proposed to manage and disperse surface water runoff within the proposed development with no discharge off site. Sufficient attenuation will be provided within the site for two consecutive 1 in 100 year storm events including appropriate allowances for climate change.

6.1.3 The surface water management proposals are discussed in further detail below.

### **6.2 Residual Risk**

6.2.1 There is always a possibility of a storm event that exceeds the design standards of the proposed flood risk management measures for new developments. Potential risks include the exceedance of the surface water attenuation facilities during extreme storm events.

6.2.2 Surface water attenuation features within the site will be designed to provide sufficient attenuation for two consecutive 1 in 100 year (plus climate change) storm events. If the capacity of the attenuation features is exceeded by an extreme storm event, exceedance flows will follow the existing topography northwards and north-westwards, with no increased risk to areas previously unaffected by surface water runoff.

## 7 DRAINAGE STRATEGY

### 7.1 Surface Water Drainage Strategy

7.1.1 Surface water runoff from the development will be controlled on site to ensure that there is no increase in the risk of flooding to areas downstream of the site and to the development itself.

7.1.2 Standard S1 of the Sustainable Drainage Systems Standards for Wales H stipulates a hierarchy for the disposal of surface water which should be followed as part of any surface water drainage design. This hierarchy is as follows:

- Priority Level 1: Surface water runoff is collected for use;
- Priority Level 2: Surface water runoff is infiltrated to ground;
- Priority Level 3: Surface water runoff is discharged to a surface water body;
- Priority Level 4: Surface water runoff is discharged to a surface water sewer, highway drain, or another drainage system.

7.1.3 In accordance with this hierarchy, it is proposed that SuDS features are designed to promote infiltration. However, due to the impermeable 'peaty' soils at the site it is assumed that this will not be the primary form of discharge from the site. Detailed permeability testing will be carried out at the detailed design stage in accordance with BRE 365 in order to assess the permeability of the underlying ground and determine the feasibility of infiltration drainage.

7.1.4 The proposed surface water management plan is shown on Drawing No. ST19905-019-P0 'Indicative Surface Water Management Plan'. Surface water runoff from the site access will discharge to the drainage ditch adjacent to the southern boundary. Surface water runoff from the proposed development will discharge to the ordinary watercourse to the west of the development in accordance with item (ii) of the hierarchy. Discharge will be restricted to the QBAR greenfield runoff rate for all storm events up to and including the 1 in 100 year storm event (plus a 40% climate change allowance) with all flows in excess of this rate attenuated within the proposed development.

### 7.2 Greenfield Runoff Rate

7.2.1 Based on Drawing No. 20221205 'Site Layout', there will be approximately 1.51ha of 'impermeable' area within the proposed development, including a 0.69ha hardstanding platform, 0.16ha of structures, and 0.66ha of semi permeable porous gravel. The porous gravel has been considered as 50% impermeable as a conservative

estimate, therefore, contributing an effective impermeable area of approximately 0.33ha. Therefore, the total effective impermeable area for the site is 1.18ha.

7.2.2 The existing greenfield runoff rates for the 2.24ha developable area have been calculated following the IH124 methodology. The greenfield calculations are contained in Appendix 2 and are summarised in Table 5 below.

Table 5. Greenfield Runoff Rates		
Return Period	Greenfield Runoff Rate (l/s)	Greenfield Runoff Rate (l/s per hectare)
QBAR	14.96	6.68
1 in 1 year	13.15	5.87
1 in 30 year	26.61	11.88
1 in 100 year	32.59	14.55

### 7.3 Surface Water Attenuation Estimates

7.3.1 Preliminary estimates of the volume of attenuation required during the 1 in 30 year (40%) and 1 in 100 year (+40) storm events were made using the Storage Estimate module in Causeway’s ‘Flow’ software package.

7.3.2 Attenuation calculations for the proposed development are contained in Appendix 3 and are summarised in Table 6 below.

Table 6. Preliminary Attenuation Estimates				
Catchment	Contributing Effective Impermeable Area (ha)	Discharge Rate (l/s)	1 in 30 year + 40% Climate Change (m <sup>3</sup> )	1 in 100 year +40% Climate Change (m <sup>3</sup> )
Main Site	1.08	12.9	972	1245.5
Access Road	0.1	2	57	76.5
1. Attenuations estimates are based off an infiltration rate of 0 as a ‘worst case’ scenario				

### 7.4 Surface Water Quality

7.4.1 Following the Simple Index Approach outlined in the CIRIA SuDS Manual, appropriate treatment will be provided within the proposed development to ensure that water quality standards are met.

- 7.4.2 The Simple Index Approach identifies Pollution Hazard Indices for Total Suspended Solids, Metals and Hydrocarbons, for different types of land use. Access roads and areas of car parking will have a ‘Medium’ pollution hazard level, and the building roofs and footpaths with no vehicular access will have a ‘Low’ pollution hazard level.
- 7.4.3 To ensure that water quality standards are met, the Pollution Mitigation Indices provided by the sustainable drainage features need to be greater than or equal to the Pollution Hazard Indices.
- 7.4.4 Surface water treatment will be provided primarily by filter trenches around the perimeter of the hardstanding.
- 7.4.5 The Pollution Hazard Indices and the Pollution Mitigation Indices for the proposed development, based on Table 26.2 and 26.3 of the SuDS Manual, are presented in Table 7 below. Table 7 confirms that sufficient treatment will be provided within the proposed surface water drainage network for the proposed land uses.

<b>Table 7. CIRIA Simple Index Approach Assessment</b>			
	<b>TSS</b>	<b>Metals</b>	<b>Hydrocarbons</b>
Pollution Hazard Indices – Commercial Yard (Low)	0.7	0.6	0.7
Pollution Mitigation Indices – Filter Drain	0.4	0.4	0.4
Pollution Mitigation Indices – Proprietary Treatment Systems (eg oil interceptors)	These shall demonstrate that they can address each of the contaminant types to acceptable levels for frequent events up to approximately the 1 in 1 year return period event, for inflow concentrations relevant to the contributing drainage area.		
<b>Sufficient or Additional Treatment Required</b>	<b>Sufficient</b>	<b>Sufficient</b>	<b>Sufficient</b>

7.4.6 Additional SuDS features which may be appropriate within the proposed development, are included in Table 8 below. The final Surface Water Drainage Strategy will be fully designed post-planning and following appropriate BRE365 testing.

<b>Table 8. Sustainable Drainage System (SuDS) Options and Suitability</b>			
<b>Type</b>	<b>Device</b>	<b>Description</b>	<b>Suitability</b>
<b>Source Control</b>	Green roof	Green roofs are systems which cover a building's roof with vegetation. They are laid over a drainage layer, with other layers providing protection, waterproofing and insulation.	Green roofs may be suitable for commercial rooftops
	Infiltration devices	Infiltration devices temporarily store runoff from a development and allow it to percolate into the ground.	Detailed permeability testing will be carried out at the design stage in accordance with BRE365 in order to assess the permeability of the underlying ground to determine the feasibility of infiltration drainage
	Pervious surfaces	Pervious surfaces allow rainwater to infiltrate through the surface into an underlying storage layer, where water is stored before infiltration to the ground, reuse, or release to surface water or sewers.	Permeable paving would be suitable in the area of porous gravel in this site. This would allow surface water to be filtered through the paving as a means of treatment. The base of the permeable paving could be unlined to promote any infiltration or lined to collect runoff and discharge to attenuation areas, based on the results of the infiltration testing in line with BRE365.
	Bioretention systems	Shallow landscaped depressions (eg tree pits, rain gardens) generally used for intercepting, managing and treating runoff from frequent rainfall events.	Suitable for use in open space. Runoff would be filtered through soils and vegetation and collected in an underdrain system to infiltrate to ground or discharge to attenuation areas.

<b>Table 8. Sustainable Drainage System (SuDS) Options and Suitability</b>			
<b>Type</b>	<b>Device</b>	<b>Description</b>	<b>Suitability</b>
Passive treatment/ end of pipe treatment	Underground attenuation	Underground attenuation can be used where other forms of SuDS are not appropriate for the site. Underground attenuation stores water for volumes above the allowable discharge rate and releases the water at the restricted discharge rate.	Underground attenuation would be suitable for use on the site. Unlined underground attenuation would allow some infiltration to ground.

## 8 CONCLUSIONS

- 8.1.1 This report gives detailed of the Flood Consequences Assessment, which has been carried out in accordance with TAN15. The site is located within Flood Zone A, described in TAN15 as an area '*considered to be at little or no risk of fluvial or tidal/coastal flooding*' on the Welsh Government's Development Advice Map.
- 8.1.2 The proposed development is a 'Greener Grid Park' energy centre which is categorised as 'Less Vulnerable' development and, based on Figure 2 of TAN15, a Less Vulnerable development is permitted in Flood Zone A. Therefore, the Justification Test is not required.
- 8.1.3 The risk of fluvial, surface water, and artificial flooding are considered to be Very Low, and the risk of groundwater flooding is considered to be Low. Tidal and sewer flooding are both discounted.
- 8.1.4 Flood risk management measures will be put in place to ensure that the risk of flooding to areas downstream of the site are not increased as a result of the development. This will include a surface water drainage strategy that will mimic greenfield performance for a range of storm events.
- 8.1.5 A Surface Water Management Plan will demonstrate that on-site attenuation will be provided by Sustainable Drainage Systems (SuDS) features to accommodate flows in exceedance of the discharge rate up to and including the 1 in 100 year storm event, including an appropriate allowance for climate change.
- 8.1.6 As the risk of flooding to the site is generally considered to be Low to Very Low, and the risk of flooding to surrounding areas will not increase as a result of the proposed development, it is considered that, from a flood risk and drainage perspective, the site is suitable for the type of development proposal.







## APPENDICES

**APPENDIX 1**  
**Utilities Report**



# Utilities Report

## Utility Type

	Electricity	STATUS: AFFECTED NUMBER AFFECTED: 3
	Gas	STATUS: AFFECTED NUMBER AFFECTED: 1
	Water and Sewerage	STATUS: AFFECTED NUMBER AFFECTED: 1
	Telecoms	STATUS: AFFECTED NUMBER AFFECTED: 3
	Other	STATUS: AFFECTED NUMBER AFFECTED: 2

Total Number of Utility Companies Contacted: 19

## Report Information

	Works Description: Building works (low rise) including tree planting and Installation of fencing, barriers, bollards, signage.
	Batch: A

Status: Awaiting Further Responses

This report is issued for the site described as:

**Site near Rhydypany Road, Felindre, Swansea**

Report Number  
**LM / 115410**

National Grid Reference  
**265249 200946,265428 201045,264081 200648,265375 201253,264083 200639**

Customer Reference  
**304591610\_1**

Report Date  
**07 December 2022**

## CONTACT DETAILS

If you require any assistance, please contact our customer services team on:

**0844 844 9960**

or by email at:  
**customerservice@promap.co.uk**

# Utilities Report

## Understanding this report

We have asked a comprehensive list of Utility companies whether they have any apparatus or underground services in the vicinity of the site.

---

### Report Summary

The table provides a breakdown of the number of responses received by utility category; however, it must be noted that some utility companies provide services across multiple categories. As a result, the total number of responses gathered will often be greater than the total number of utility companies contacted.

### Location Map

This shows the plan that was dispatched to the Utility companies. The companies have been asked to return information on the area outlined, which will encompass your chosen site.

### Request Status Report

This will confirm the current status of the information requests. We list which responses we have received and whether the company is affected. The Status Report will be divided into the following sections.

**Affected Utilities** – We have received plans/information

**No Response Received** – We are still awaiting a full response

**Not affected Utilities** – We have received a not affected/no plant present response

### Responses

Affected responses are listed by company. Any responses from companies confirming they are not affected are provided at the back of the report for your records.

### ‘Awaiting Further Responses’ or ‘Pack Complete’?

We do not include Local Authority requests when indicating if the pack is ‘Complete’ or ‘Awaiting Further Responses’ as Local Authorities are not obliged to reply to these enquiries.

The local authority for the area is contacted to see if they have any council owned property that may be affected by works. In general, these plant enquiries go to the highways department for responses regarding street lighting and drainage. However, the responses we receive can vary each time depending on resources available at the council and we often don’t receive replies from local authorities at all

# Utilities Report

## Landmark Utilities Report Service PAS 128 Statement

---

Prepared for: **Landmark Information Group Ltd**  
Practitioner: **Atkins**  
Report Number: LM / 115410  
Client Reference: 304591610\_1  
Site Name: Site near Rhydybandy Road, Felindre, Swansea  
Date of Order: 01 December 2022  
Date of Issue: 07 December 2022

Thank you for using our Utility Report Service.

**This report has been completed in accordance with the standards defined under Survey Category D of PAS128, a Publicly Available Specification for underground utility detection, verification and location published by the British Standards Institution.**

**Positional accuracy of plant is not guaranteed from information presented in a desktop search alone and the location of underground utilities should be verified through other means prior to breaking ground.**

Information relating to the presence of Radio Frequency Identification Devices (RFIDs) has been requested from relevant utility companies or taken from mapping systems where available.

Utility companies who have not responded to enquiries are referenced on the enclosed Status Report accordingly. Their response will be chased and forwarded on for a period of up to four working weeks. Whilst we cannot guarantee that a utility company will respond to our enquiries, we endeavour to obtain responses from those that have not responded.

Any responses contained within this report have been obtained between the start date of the order and the date of issue.

If you want to discuss your report further with us, please contact Landmark Customer Services.

# Utilities Report

 Search data map

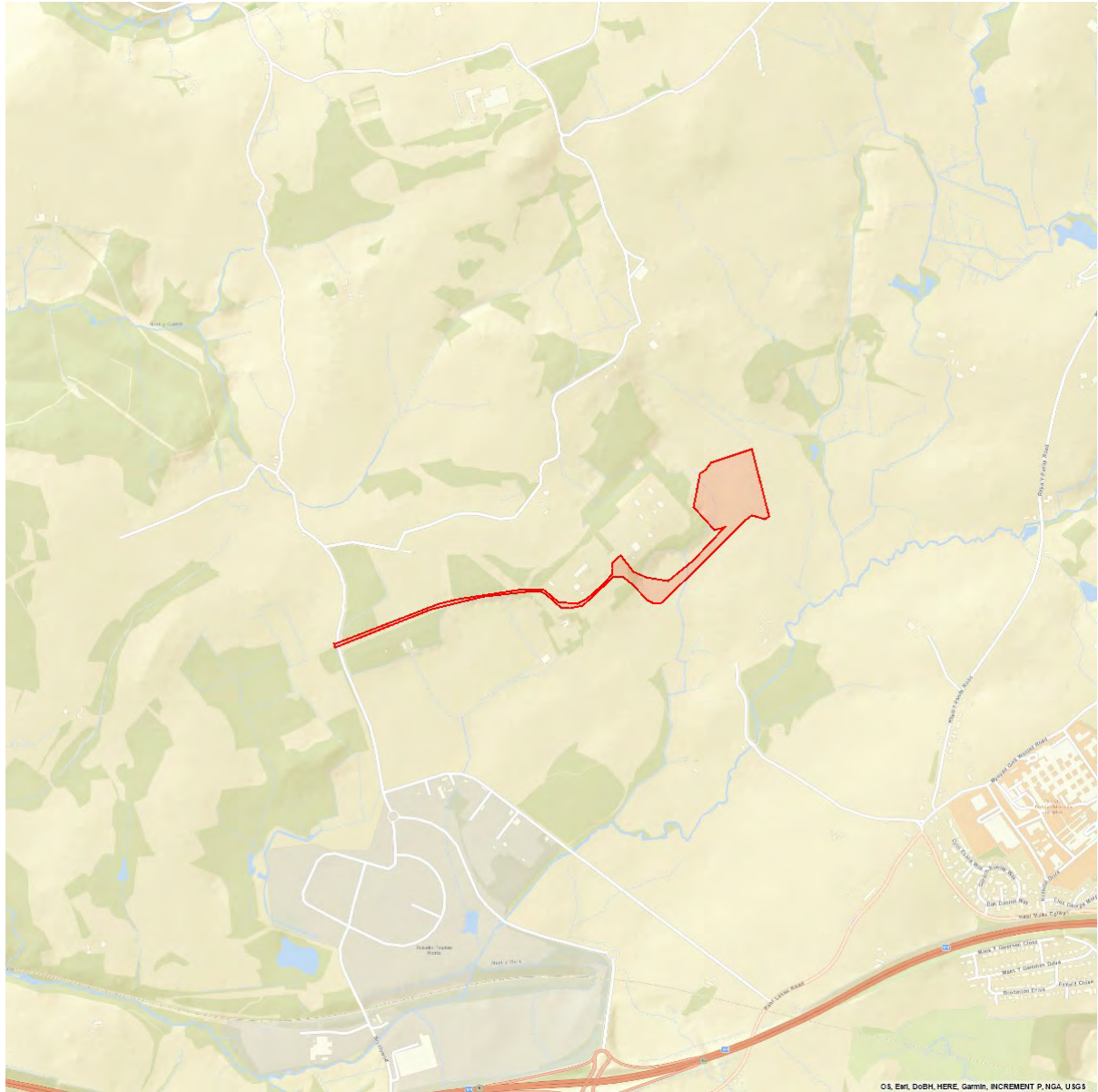

**Please ensure that search data covers the COMPLETE AREA within the boundary lines on this map. This is marked by **

Landmark will not be held responsible for any incident or accident arising from the use of the information associated with this particular Statutory Search. The details provided are given in good faith, but no liability whatsoever can be accepted in respect thereof.

Client Reference:  
304591610\_1

Route:  
Site near Rhydypany Road, Felindre, Swansea

Postcode:

OSGR:  
265170 201010

Check by:  
BRK

# Utilities Report

## Request Status Report

Route:  
Site near Rhydypany Road,  
Felindre, Swansea

Postcode:

OSGR:  
265170 201010

Date Requested:  
01 December 2022

Client Reference:  
304591610\_1

Report Number:  
LM / 115410

Checked and Validated By:  
AB

Validation Date:  
07 December 2022

### Affected Utilities

We have received plans/information from the following companies. Please see the enclosed response.

Utility	Category	Date Issued	Notes
Dŵr Cymru Welsh Water	Water, Sewerage	07 December 2022	Water - affected. Sewer - not affected.
LinesearchbeforeUdig	Other	07 December 2022	National Grid Electricity Distribution, National Grid Electricity Transmission, National Grid Gas Transmission, Wales and West Utilities - identified as affected. See separate responses.
National Grid Electricity Distribution	Electric, Telecom	07 December 2022	
National Grid Electricity Transmission	Electric	07 December 2022	See response.
Natural Resources Wales	Environmental Agency	07 December 2022	See response.
Openreach - [British Telecommunications]	Telecom	07 December 2022	
Utility Assets	Electric	07 December 2022	See response.
Vodafone	Telecom	07 December 2022	See response. Only affected sent.
Wales and West Utilities	Gas	07 December 2022	

# Utilities Report

## No Response Received

We are still awaiting a full response from the following companies.

Utility	Category	Date Issued	Notes
C.A. Telecom UK - [Colt Technology Services]	Telecom		

## Not Affected Utilities

We have received a not affected/no plant present response from the following companies.

Utility	Category	Date Issued	Notes
City and County of Swansea Council	Council	07 December 2022	
CityFibre	Telecom	07 December 2022	
GTC	Telecom, Gas, Electric, Water	07 December 2022	
Instalcom - [CenturyLink, Global Crossing, Fibernet & Fibrespan]	Telecom	07 December 2022	
National Grid Gas Transmission	Gas	07 December 2022	
Network Rail	Rail	07 December 2022	
SKY Telecommunications Services	Telecom	07 December 2022	
Verizon	Telecom	07 December 2022	
Virgin Media	Telecom	07 December 2022	





## Affected Utilities







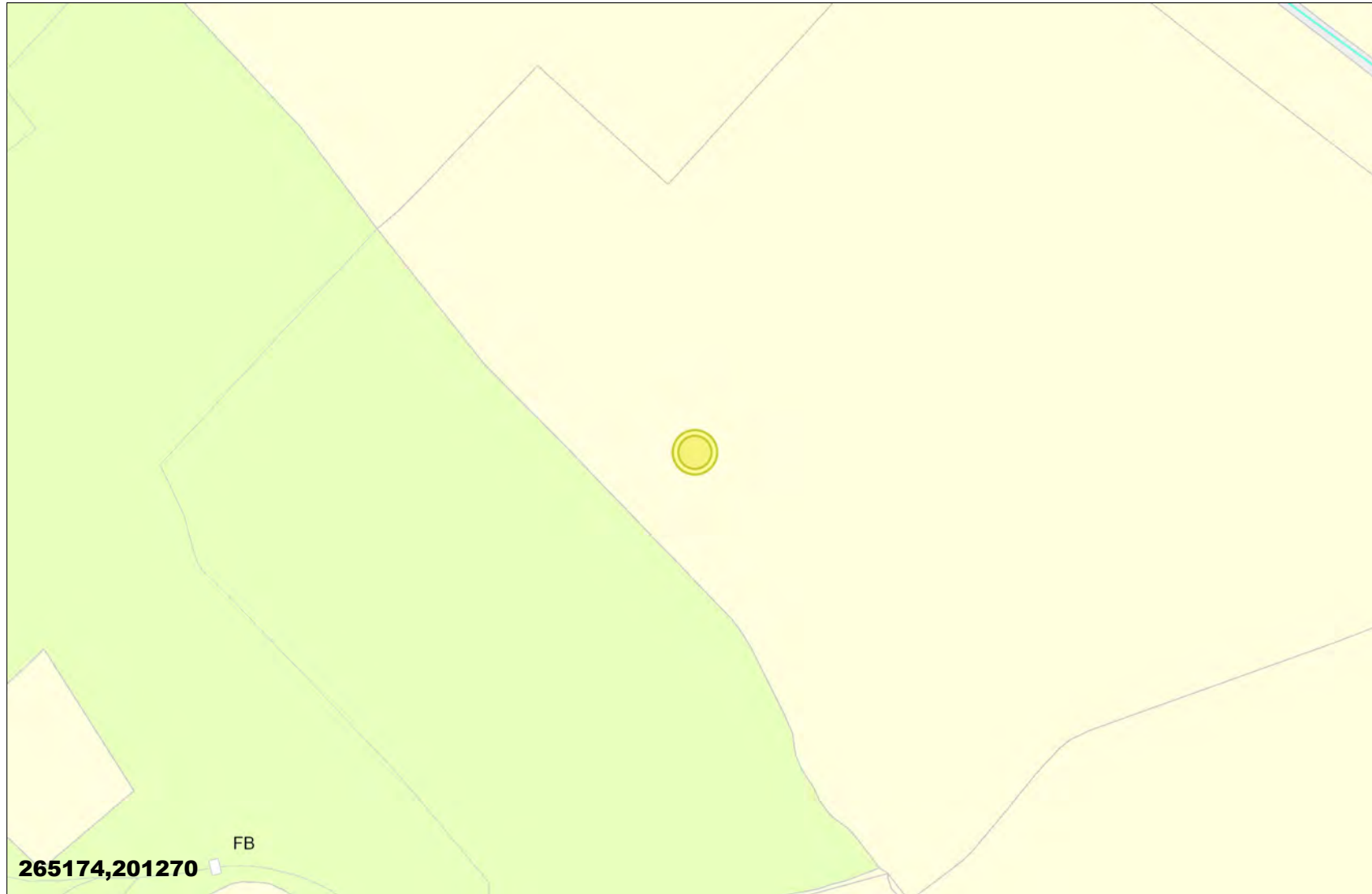



Affected Utilities

Dŵr Cymru Welsh Water



LEGEND















Clean Water

-  Sluice Val
-  Air Val, SINGLE
-  Tap
-  Pressure Reducing Valve
-  Meter
-  BULK Meter
-  FH
-  Cap

Existing Main

-  Existing Main
-  NON COMPANY

Sewerage External

-  Foul
-  Surface Water
-  Combined
-  Rising Main
-  Private
-  Treatment Works
-  Pumping Station
-  Special Purpose
-  Unknown End
-  Change, Combined Overflow
-  Outfall, FOUL
-  Lamp Hole, Foul
-  Private Sewer Transfer
-  Lateral Drain
-  Inspection Chamber

265174,201270

FB

Dwr Cymru Cyfyngedig ('the Company') gives this information as to the position of its underground apparatus by way of general guidance only and on the strict understanding that it is based on the best information available and no warranty as to its correctness is relied upon. In the event of excavations or other works made in the vicinity of the company's apparatus and any onus of locating the apparatus before carrying out any excavations rests entirely on you. The information which is supplied hereby the company, is done so in accordance with statutory requirements of sections 198 and 199 of the water industry Act 1991 based upon the best information available and in particular, but without prejudice to the generality of the foregoing, it should be noted that the records that are available to the Company may not disclose the existence of a drain sewer or disposal main laid before 1 September 1989, or if they do, the particulars thereof including their position underground may not be accurate. It must be understood that the furnishing of this information is entirely without prejudice to the provision of the New Roads and Street Works Act 1991 and the company's right to be compensated for any damage to its apparatus.

**EXACT LOCATION OF ALL APPARATUS TO BE DETERMINED ON SITE**











Reproduced from the Ordnance Survey's maps with the permission of the Controller of Her Majesty's Stationary Office. Crown Copyright. Licence No: WU298565.

Whilst every reasonable effort has been taken to correctly record the pipe material of DCWW assets, there is a possibility that in some cases pipe material (other than Asbestos Cement or Pitch Fibre) may be found to be Asbestos Cement (AC) or Pitch Fibre (PF). It is therefore advisable that the possible presence of AC or PF pipes be anticipated and considered as part of any risk assessment prior to excavation.





**LEGEND**

**Clean Water**

-  Sluice Val
-  Air Val, SINGLE
-  Tap
-  Pressure Reducing Valve
-  Meter
-  BULK Meter
-  FH
-  Cap
-  Existing Main
-  NON COMPANY

**Sewerage External**

-  Foul
-  Surface Water
-  Combined
-  Rising Main
-  Private
-  Treatment Works
-  Pumping Station
-  Special Purpose
-  Unknown End
-  Change, Combined Overflow
-  Outfall, FOUL
-  Lamp Hole, Foul
-  Private Sewer Transfer
-  Lateral Drain
-  Inspection Chamber

265439,201270

Dwr Cymru Cyfyngedig ('the Company') gives this information as to the position of its underground apparatus by way of general guidance only and on the strict understanding that it is based on the best information available and no warranty as to its correctness is relied upon in the event of excavations or other works made in the vicinity of the company's apparatus and any onus of locating the apparatus before carrying out any excavations rests entirely on you. The information which is supplied hereby by the company, is done so in accordance with statutory requirements of sections 198 and 199 of the Water Industry Act 1991 based upon the best information available and in particular, but without prejudice to the generality of the foregoing, it should be noted that the records that are available to the Company may not disclose the existence of a drain sewer or disposal main laid before 1 September 1989, or if they do, the particulars thereof including their position underground may not be accurate. It must be understood that the furnishing of this information is entirely without prejudice to the provision of the New Roads and Street Works Act 1991 and the company's right to be compensated for any damage to its apparatus.

**EXACT LOCATION OF ALL APPARATUS TO BE DETERMINED ON SITE**





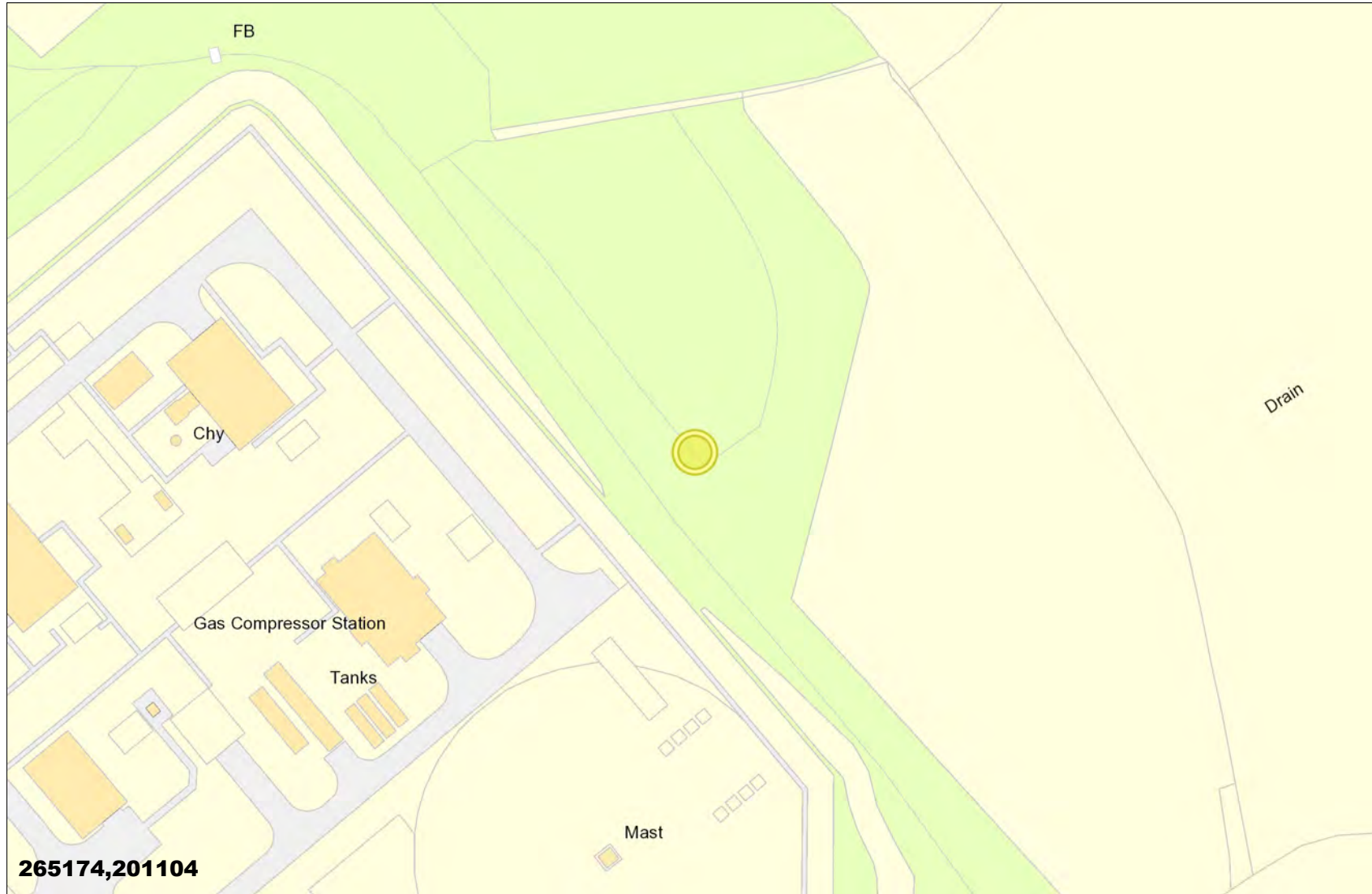



Reproduced from the Ordnance Survey's maps with the permission of the Controller of Her Majesty's Stationary Office. Crown Copyright. Licence No: WU298565.

Whilst every reasonable effort has been taken to correctly record the pipe material of DCWW assets, there is a possibility that in some cases pipe material (other than Asbestos Cement or Pitch Fibre) may be found to be Asbestos Cement (AC) or Pitch Fibre (PF). It is therefore advisable that the possible presence of AC or PF pipes be anticipated and considered as part of any risk assessment prior to excavation.



**LEGEND**















**Clean Water**

-  Sluice Val
-  Air Val, SINGLE
-  Tap
-  Pressure Reducing Valve
-  Meter
-  BULK Meter
-  FH
-  Cap

**Existing Main**

-  Existing Main
-  NON COMPANY

**Sewerage External**

-  Foul
-  Surface Water
-  Combined
-  Rising Main
-  Private
-  Treatment Works
-  Pumping Station
-  Special Purpose
-  Unknown End
-  Change, Combined Overflow
-  Outfall, FOUL
-  Lamp Hole, Foul
-  Private Sewer Transfer
-  Lateral Drain
-  Inspection Chamber

Dwr Cymru Cyfyngedig ('the Company') gives this information as to the position of its underground apparatus by way of general guidance only and on the strict understanding that it is based on the best information available and no warranty as to its correctness is relied upon in the event of excavations or other works made in the vicinity of the company's apparatus and any onus of locating the apparatus before carrying out any excavations rests entirely on you. The information which is supplied hereby by the company, is done so in accordance with statutory requirements of sections 198 and 199 of the water industry Act 1991 based upon the best information available and in particular, but without prejudice to the generality of the foregoing, it should be noted that the records that are available to the Company may not disclose the existence of a drain sewer or disposal main laid before 1 September 1989, or if they do, the particulars thereof including their position underground may not be accurate. It must be understood that the furnishing of this information is entirely without prejudice to the provision of the New Roads and Street Works Act 1991 and the company's right to be compensated for any damage to its apparatus.

**EXACT LOCATION OF ALL APPARATUS TO BE DETERMINED ON SITE**

Reproduced from the Ordnance Survey's maps with the permission of the Controller of Her Majesty's Stationary Office. Crown Copyright. Licence No: WU298565.











Whilst every reasonable effort has been taken to correctly record the pipe material of DCWW assets, there is a possibility that in some cases pipe material (other than Asbestos Cement or Pitch Fibre) may be found to be Asbestos Cement (AC) or Pitch Fibre (PF). It is therefore advisable that the possible presence of AC or PF pipes be anticipated and considered as part of any risk assessment prior to excavation.

















**265439,201104**

**LEGEND**

**Clean Water**

-  Sluice Val
-  Air Val, SINGLE
-  Tap
-  Pressure Reducing Valve
-  Meter
-  BULK Meter
-  FH
-  Cap
-  Existing Main
-  NON COMPANY

**Sewerage External**

-  Foul
-  Surface Water
-  Combined
-  Rising Main
-  Private
-  Treatment Works
-  Pumping Station
-  Special Purpose
-  Unknown End
-  Change, Combined Overflow
-  Outfall, FOUL
-  Lamp Hole, Foul
-  Private Sewer Transfer
-  Lateral Drain
-  Inspection Chamber

Dwr Cymru Cyfyngedig ('the Company') gives this information as to the position of its underground apparatus by way of general guidance only and on the strict understanding that it is based on the best information available and no warranty as to its correctness is relied upon. In the event of excavations or other works made in the vicinity of the company's apparatus and any onus of locating the apparatus before carrying out any excavations rests entirely on you. The information which is supplied hereby the company, is done so in accordance with statutory requirements of sections 198 and 199 of the water industry Act 1991 based upon the best information available and in particular, but without prejudice to the generality of the foregoing, it should be noted that the records that are available to the Company may not disclose the existence of a drain sewer or disposal main laid before 1 September 1989, or if they do, the particulars thereof including their position underground may not be accurate. It must be understood that the furnishing of this information is entirely without prejudice to the provision of the New Roads and Street Works Act 1991 and the company's right to be compensated for any damage to its apparatus.

**EXACT LOCATION OF ALL APPARATUS TO BE DETERMINED ON SITE**





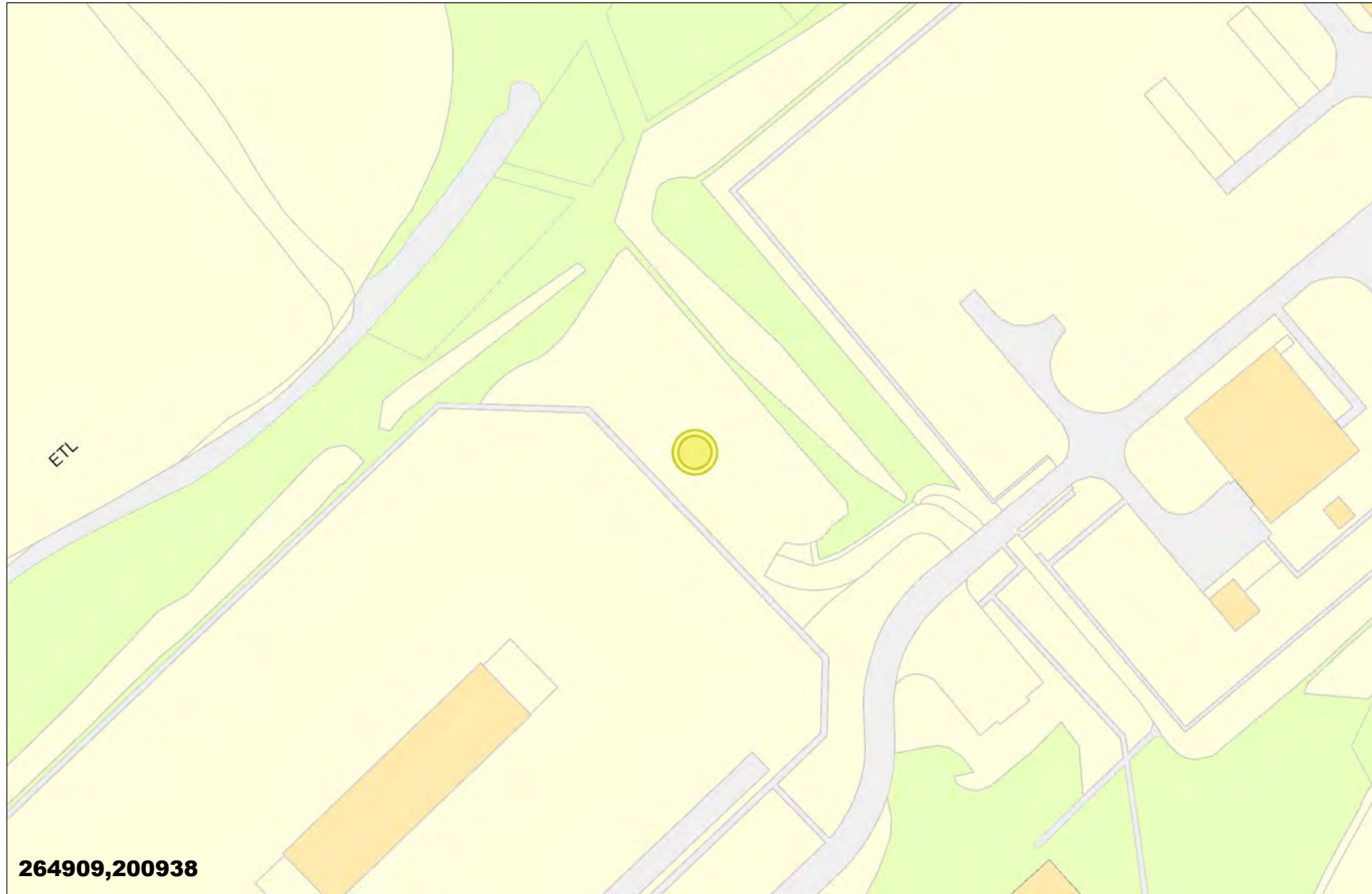





Reproduced from the Ordnance Survey's maps with the permission of the Controller of Her Majesty's Stationary Office. Crown Copyright. Licence No: WU298565.

Whilst every reasonable effort has been taken to correctly record the pipe material of DCWW assets, there is a possibility that in some cases pipe material (other than Asbestos Cement or Pitch Fibre) may be found to be Asbestos Cement (AC) or Pitch Fibre (PF). It is therefore advisable that the possible presence of AC or PF pipes be anticipated and considered as part of any risk assessment prior to excavation.

















**LEGEND**

**Clean Water**

-  Sluice Val
-  Air Val, SINGLE
-  Tap
-  Pressure Reducing Valve
-  Meter
-  BULK Meter
-  FH
-  Cap
-  Existing Main
-  NON COMPANY

**Sewerage External**

-  Foul
-  Surface Water
-  Combined
-  Rising Main
-  Private
-  Treatment Works
-  Pumping Station
-  Special Purpose
-  Unknown End
-  Change, Combined Overflow
-  Outfall, FOUL
-  Lamp Hole, Foul
-  Private Sewer Transfer
-  Lateral Drain
-  Inspection Chamber

**264909,200938**

Dwr Cymru Cyfyngedig ('the Company') gives this information as to the position of its underground apparatus by way of general guidance only and on the strict understanding that it is based on the best information available and no warranty as to its correctness is relied upon in the event of excavations or other works made in the vicinity of the company's apparatus and any onus of locating the apparatus before carrying out any excavations rests entirely on you. The information which is supplied hereby by the company, is done so in accordance with statutory requirements of sections 198 and 199 of the water industry Act 1991 based upon the best information available and in particular, but without prejudice to the generality of the foregoing, it should be noted that the records that are available to the Company may not disclose the existence of a drain sewer or disposal main laid before 1 September 1989, or if they do, the particulars thereof including their position underground may not be accurate. It must be understood that the furnishing of this information is entirely without prejudice to the provision of the New Roads and Street Works Act 1991 and the company's right to be compensated for any damage to its apparatus.

**EXACT LOCATION OF ALL APPARATUS TO BE DETERMINED ON SITE**





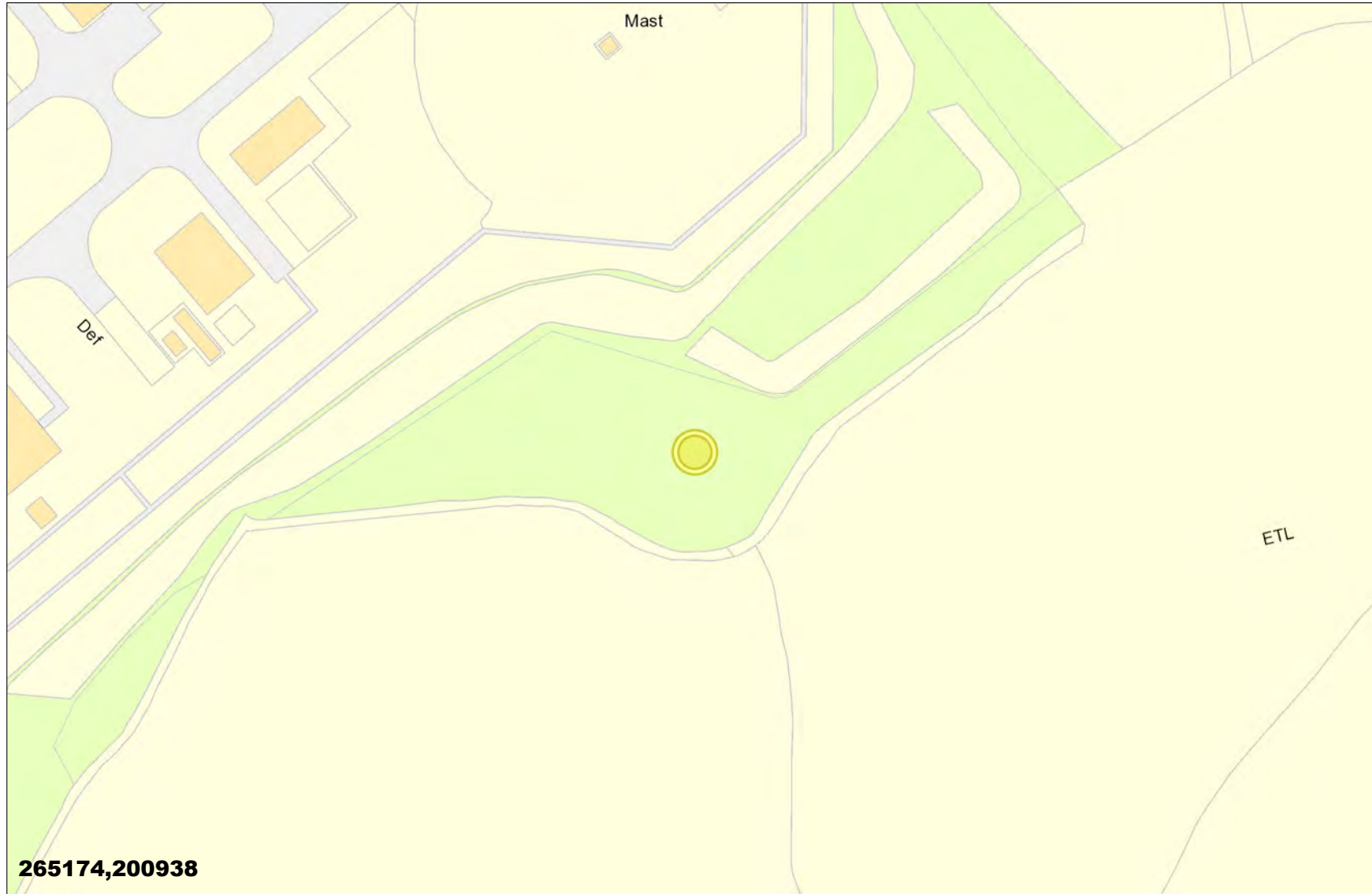





Reproduced from the Ordnance Survey's maps with the permission of the Controller of Her Majesty's Stationary Office. Crown Copyright. Licence No: WU298565.

Whilst every reasonable effort has been taken to correctly record the pipe material of DCWW assets, there is a possibility that in some cases pipe material (other than Asbestos Cement or Pitch Fibre) may be found to be Asbestos Cement (AC) or Pitch Fibre (PF). It is therefore advisable that the possible presence of AC or PF pipes be anticipated and considered as part of any risk assessment prior to excavation.



**LEGEND**

**Clean Water**

-  Sluice Val
-  Air Val, SINGLE
-  Tap
-  Pressure Reducing Valve
-  Meter
-  BULK Meter
-  FH
-  Cap
-  Existing Main
-  NON COMPANY

**Sewerage External**

-  Foul
-  Surface Water
-  Combined
-  Rising Main
-  Private
-  Treatment Works
-  Pumping Station
-  Special Purpose
-  Unknown End
-  Change, Combined Overflow
-  Outfall, FOUL
-  Lamp Hole, Foul
-  Private Sewer Transfer
-  Lateral Drain
-  Inspection Chamber

**265174,200938**

**EXACT LOCATION OF ALL APPARATUS TO BE DETERMINED ON SITE**

Dwr Cymru Cyfyngedig ('the Company') gives this information as to the position of its underground apparatus by way of general guidance only and on the strict understanding that it is based on the best information available and no warranty as to its correctness is relied upon in the event of excavations or other works made in the vicinity of the company's apparatus and any onus of locating the apparatus before carrying out any excavations rests entirely on you. The information which is supplied hereby the company, is done so in accordance with statutory requirements of sections 198 and 199 of the water industry Act 1991 based upon the best information available and in particular, but without prejudice to the generality of the foregoing, it should be noted that the records that are available to the Company may not disclose the existence of a drain sewer or disposal main laid before 1 September 1989, or if they do, the particulars thereof including their position underground may not be accurate. It must be understood that the furnishing of this information is entirely without prejudice to the provision of the New Roads and Street Works Act 1991 and the company's right to be compensated for any damage to its apparatus.

Reproduced from the Ordnance Survey's maps with the permission of the Controller of Her Majesty's Stationary Office. Crown Copyright. Licence No: WU298565.

Whilst every reasonable effort has been taken to correctly record the pipe material of DCWW assets, there is a possibility that in some cases pipe material (other than Asbestos Cement or Pitch Fibre) may be found to be Asbestos Cement (AC) or Pitch Fibre (PF). It is therefore advisable that the possible presence of AC or PF pipes be anticipated and considered as part of any risk assessment prior to excavation.



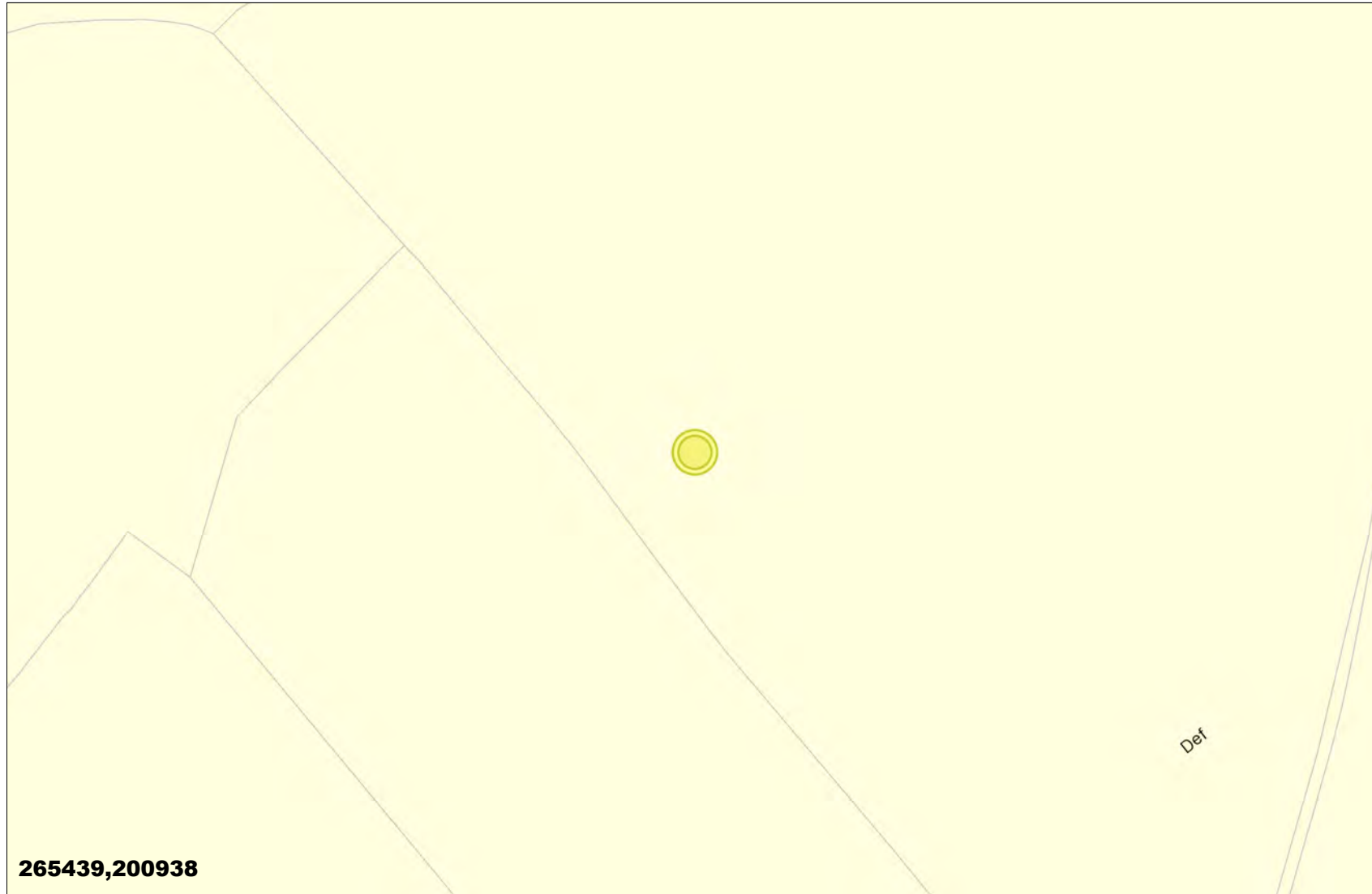







**265439,200938**

**LEGEND**











**Clean Water**

-  Sluice Val
-  Air Val, SINGLE
-  Tap
-  Pressure Reducing Valve
-  Meter
-  BULK Meter
-  FH
-  Cap

**Existing Main**

-  Existing Main
-  NON COMPANY

**Sewerage External**

-  Foul
-  Surface Water
-  Combined
-  Rising Main
-  Private
-  Treatment Works
-  Pumping Station
-  Special Purpose
-  Unknown End
-  Change, Combined Overflow
-  Outfall, FOUL
-  Lamp Hole, Foul
-  Private Sewer Transfer
-  Lateral Drain
-  Inspection Chamber

Dwr Cymru Cyfyngedig ('the Company') gives this information as to the position of its underground apparatus by way of general guidance only and on the strict understanding that it is based on the best information available and no warranty as to its correctness is relied upon. In the event of excavations or other works made in the vicinity of the company's apparatus and any onus of locating the apparatus before carrying out any excavations rests entirely on you. The information which is supplied hereby the company, is done so in accordance with statutory requirements of sections 198 and 199 of the water industry Act 1991 based upon the best information available and in particular, but without prejudice to the generality of the foregoing, it should be noted that the records that are available to the Company may not disclose the existence of a drain sewer or disposal main laid before 1 September 1989, or if they do, the particulars thereof including their position underground may not be accurate. It must be understood that the furnishing of this information is entirely without prejudice to the provision of the New Roads and Street Works Act 1991 and the company's right to be compensated for any damage to its apparatus.

**EXACT LOCATION OF ALL APPARATUS TO BE DETERMINED ON SITE**

Reproduced from the Ordnance Survey's maps with the permission of the Controller of Her Majesty's Stationary Office. Crown Copyright. Licence No: WU298565.



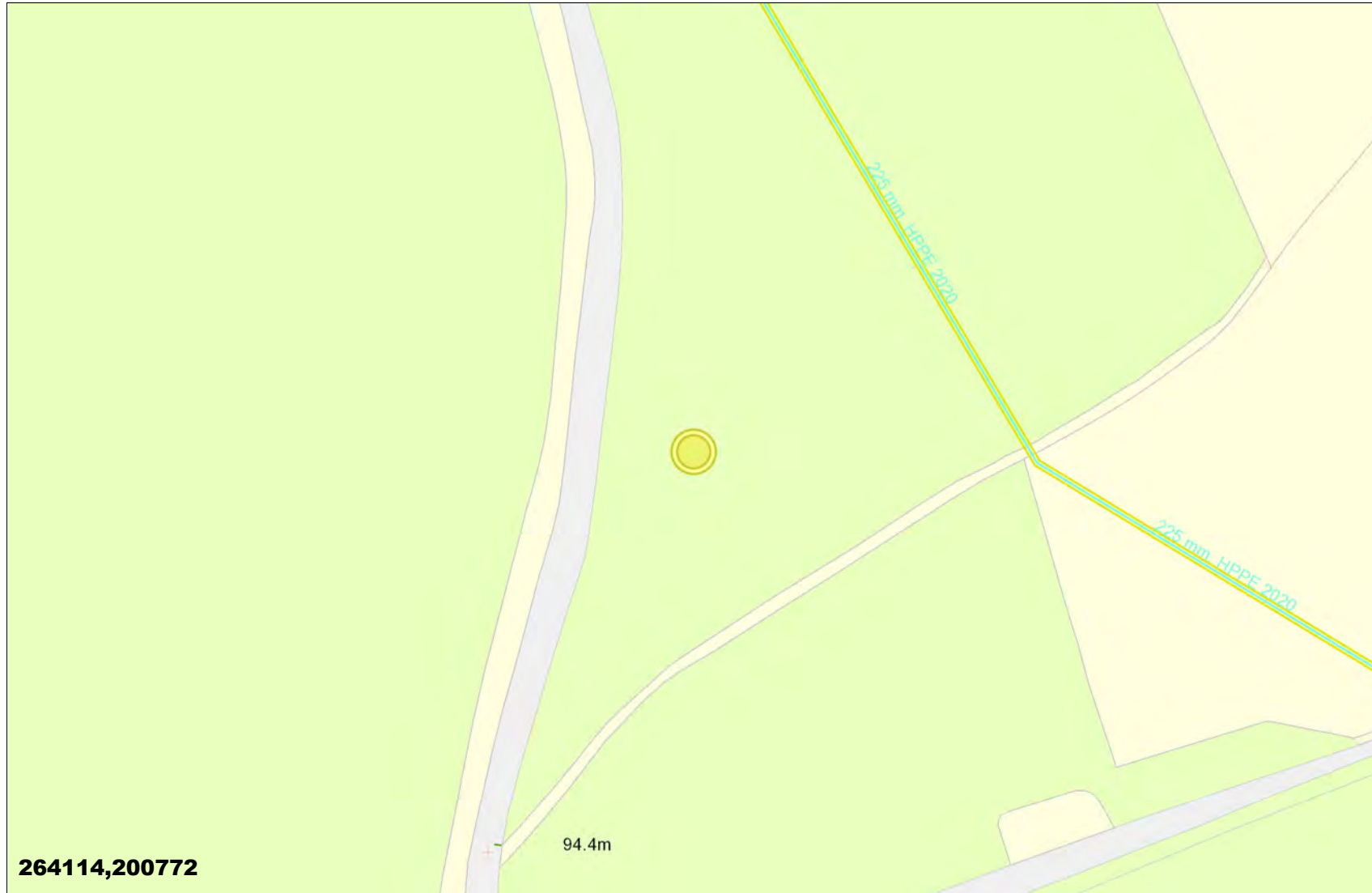







Whilst every reasonable effort has been taken to correctly record the pipe material of DCWW assets, there is a possibility that in some cases pipe material (other than Asbestos Cement or Pitch Fibre) may be found to be Asbestos Cement (AC) or Pitch Fibre (PF). It is therefore advisable that the possible presence of AC or PF pipes be anticipated and considered as part of any risk assessment prior to excavation.













**264114,200772**

**LEGEND**

**Clean Water**

-  Sluice Val
-  Air Val, SINGLE
-  Tap
-  Pressure Reducing Valve
-  Meter
-  BULK Meter
-  FH
-  Cap
-  Existing Main
-  NON COMPANY

**Sewerage External**

-  Foul
-  Surface Water
-  Combined
-  Rising Main
-  Private
-  Treatment Works
-  Pumping Station
-  Special Purpose
-  Unknown End
-  Change, Combined Overflow
-  Outfall, FOUL
-  Lamp Hole, Foul
-  Private Sewer Transfer
-  Lateral Drain
-  Inspection Chamber

Dwr Cymru Cyfyngedig ('the Company') gives this information as to the position of its underground apparatus by way of general guidance only and on the strict understanding that it is based on the best information available and no warranty as to its correctness is relied upon. In the event of excavations or other works made in the vicinity of the company's apparatus and any onus of locating the apparatus before carrying out any excavations rests entirely on you. The information which is supplied hereby the company, is done so in accordance with statutory requirements of sections 198 and 199 of the water industry Act 1991 based upon the best information available and in particular, but without prejudice to the generality of the foregoing, it should be noted that the records that are available to the Company may not disclose the existence of a drain sewer or disposal main laid before 1 September 1989, or if they do, the particulars thereof including their position underground may not be accurate. It must be understood that the furnishing of this information is entirely without prejudice to the provision of the New Roads and Street Works Act 1991 and the company's right to be compensated for any damage to its apparatus.

**EXACT LOCATION OF ALL APPARATUS TO BE DETERMINED ON SITE**





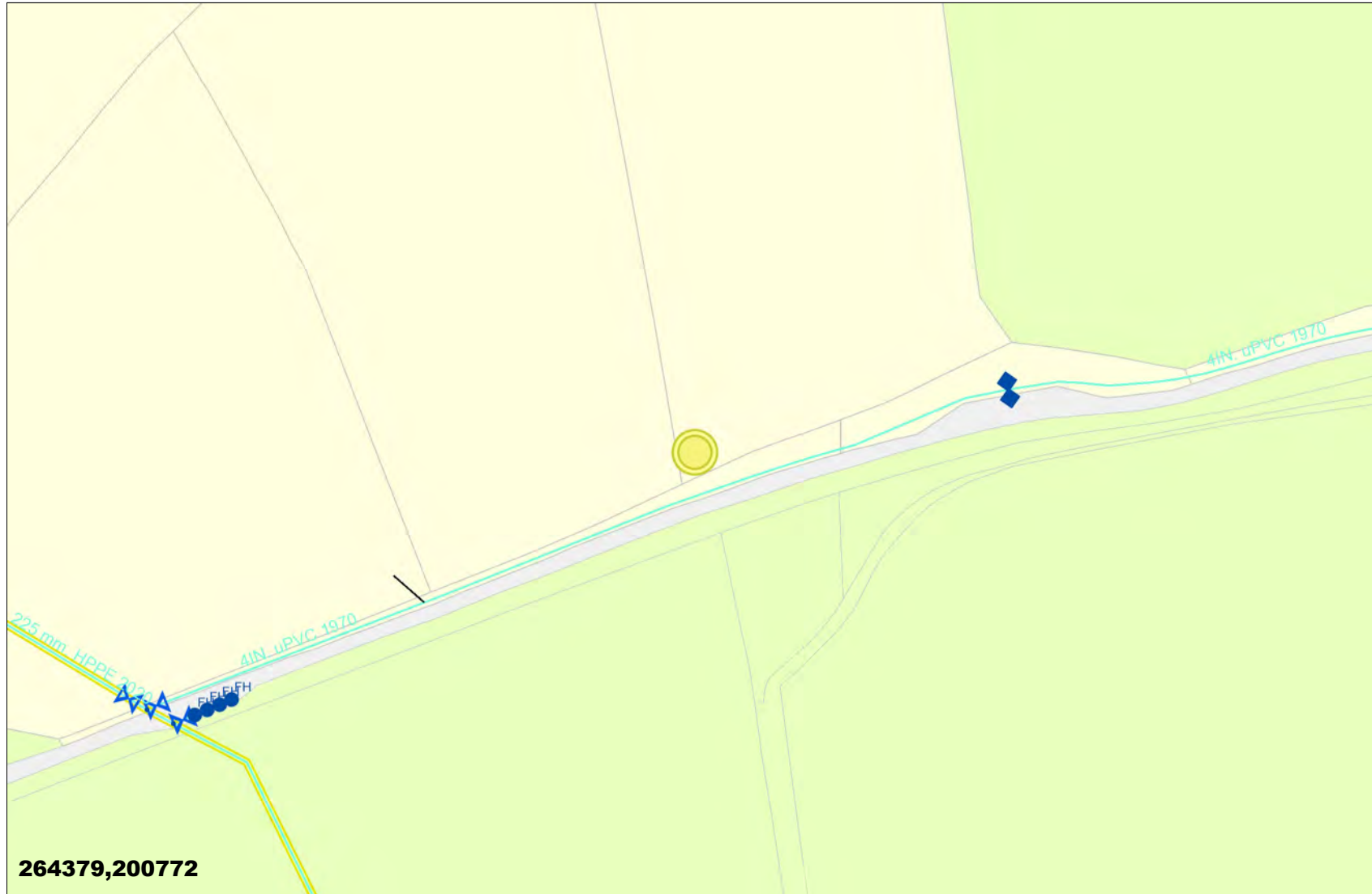





Reproduced from the Ordnance Survey's maps with the permission of the Controller of Her Majesty's Stationary Office. Crown Copyright. Licence No: WU298565.

Whilst every reasonable effort has been taken to correctly record the pipe material of DCWW assets, there is a possibility that in some cases pipe material (other than Asbestos Cement or Pitch Fibre) may be found to be Asbestos Cement (AC) or Pitch Fibre (PF). It is therefore advisable that the possible presence of AC or PF pipes be anticipated and considered as part of any risk assessment prior to excavation.





**LEGEND**

**Clean Water**

-  Sluice Val
-  Air Val, SINGLE
-  Tap
-  Pressure Reducing Valve
-  Meter
-  BULK Meter
-  FH
-  Cap
-  Existing Main
-  NON COMPANY

**Sewerage External**

-  Foul
-  Surface Water
-  Combined
-  Rising Main
-  Private
-  Treatment Works
-  Pumping Station
-  Special Purpose
-  Unknown End
-  Change, Combined Overflow
-  Outfall, FOUL
-  Lamp Hole, Foul
-  Private Sewer Transfer
-  Lateral Drain
-  Inspection Chamber

264379,200772

Dwr Cymru Cyfyngedig ('the Company') gives this information as to the position of its underground apparatus by way of general guidance only and on the strict understanding that it is based on the best information available and no warranty as to its correctness is relied upon in the event of excavations or other works made in the vicinity of the company's apparatus and any onus of locating the apparatus before carrying out any excavations rests entirely on you. The information which is supplied hereby by the company, is done so in accordance with statutory requirements of sections 198 and 199 of the Water Industry Act 1991 based upon the best information available and in particular, but without prejudice to the generality of the foregoing, it should be noted that the records that are available to the Company may not disclose the existence of a drain sewer or disposal main laid before 1 September 1989, or if they do, the particulars thereof including their position underground may not be accurate. It must be understood that the furnishing of this information is entirely without prejudice to the provision of the New Roads and Street Works Act 1991 and the company's right to be compensated for any damage to its apparatus.

**EXACT LOCATION OF ALL APPARATUS TO BE DETERMINED ON SITE**





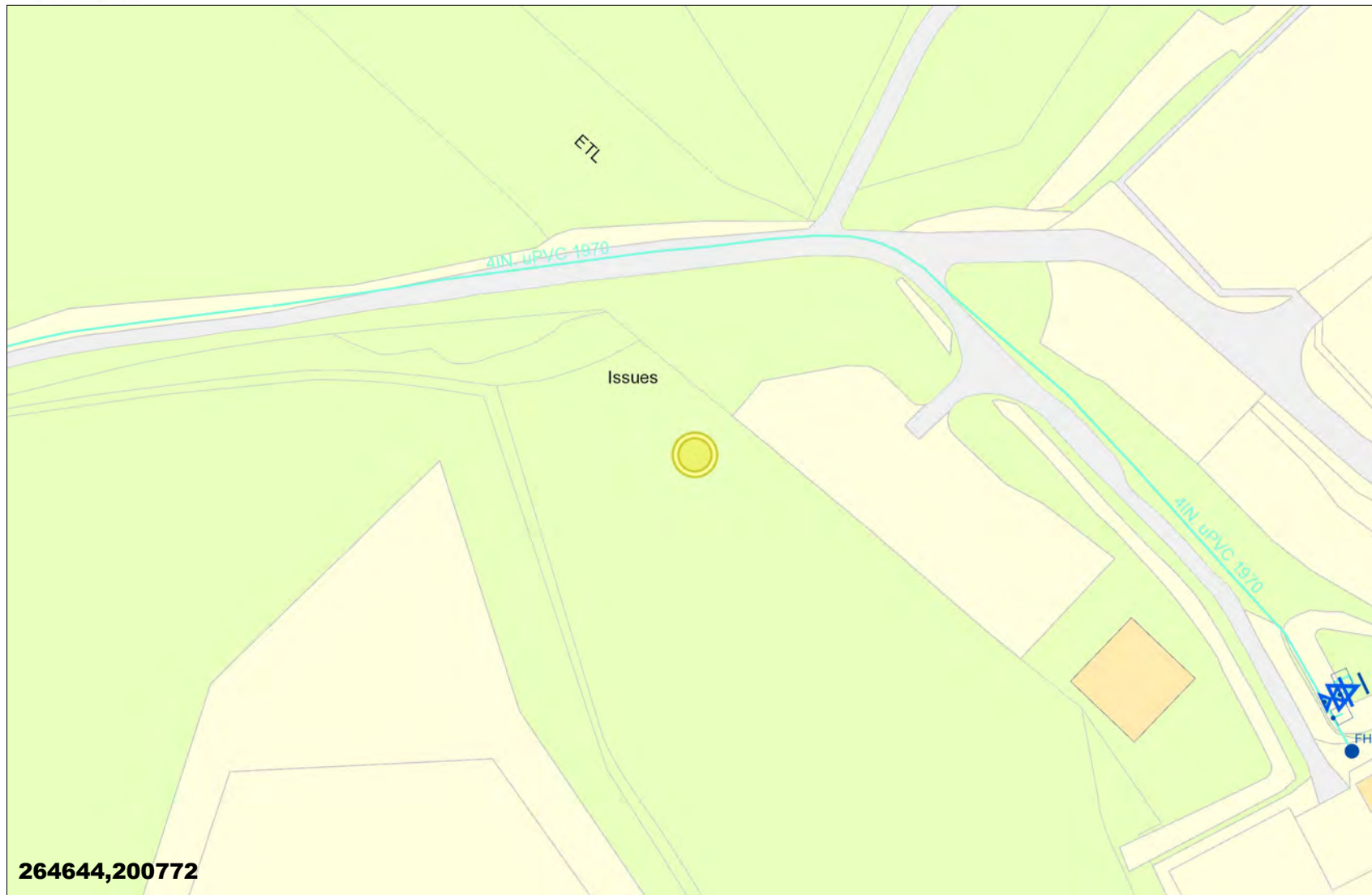





Reproduced from the Ordnance Survey's maps with the permission of the Controller of Her Majesty's Stationary Office. Crown Copyright. Licence No: WU298565.

Whilst every reasonable effort has been taken to correctly record the pipe material of DCWW assets, there is a possibility that in some cases pipe material (other than Asbestos Cement or Pitch Fibre) may be found to be Asbestos Cement (AC) or Pitch Fibre (PF). It is therefore advisable that the possible presence of AC or PF pipes be anticipated and considered as part of any risk assessment prior to excavation.



**LEGEND**

**Clean Water**

-  Sluice Val
-  Air Val, SINGLE
-  Tap
-  Pressure Reducing Valve
-  Meter
-  BULK Meter
-  FH
-  Cap
-  Existing Main
-  NON COMPANY

**Sewerage External**

-  Foul
-  Surface Water
-  Combined
-  Rising Main
-  Private
-  Treatment Works
-  Pumping Station
-  Special Purpose
-  Unknown End
-  Change, Combined Overflow
-  Outfall, FOUL
-  Lamp Hole, Foul
-  Private Sewer Transfer
-  Lateral Drain
-  Inspection Chamber

**264644,200772**

Dwr Cymru Cyfyngedig ('the Company') gives this information as to the position of its underground apparatus by way of general guidance only and on the strict understanding that it is based on the best information available and no warranty as to its correctness is relied upon. In the event of excavations or other works made in the vicinity of the company's apparatus and any onus of locating the apparatus before carrying out any excavations rests entirely on you. The information which is supplied hereby by the company, is done so in accordance with statutory requirements of sections 198 and 199 of the water industry Act 1991 based upon the best information available and in particular, but without prejudice to the generality of the foregoing, it should be noted that the records that are available to the Company may not disclose the existence of a drain sewer or disposal main laid before 1 September 1989, or if they do, the particulars thereof including their position underground may not be accurate. It must be understood that the furnishing of this information is entirely without prejudice to the provision of the New Roads and Street Works Act 1991 and the company's right to be compensated for any damage to its apparatus.

**EXACT LOCATION OF ALL APPARATUS TO BE DETERMINED ON SITE**

Reproduced from the Ordnance Survey's maps with the permission of the Controller of Her Majesty's Stationary Office. Crown Copyright. Licence No: WU298565.



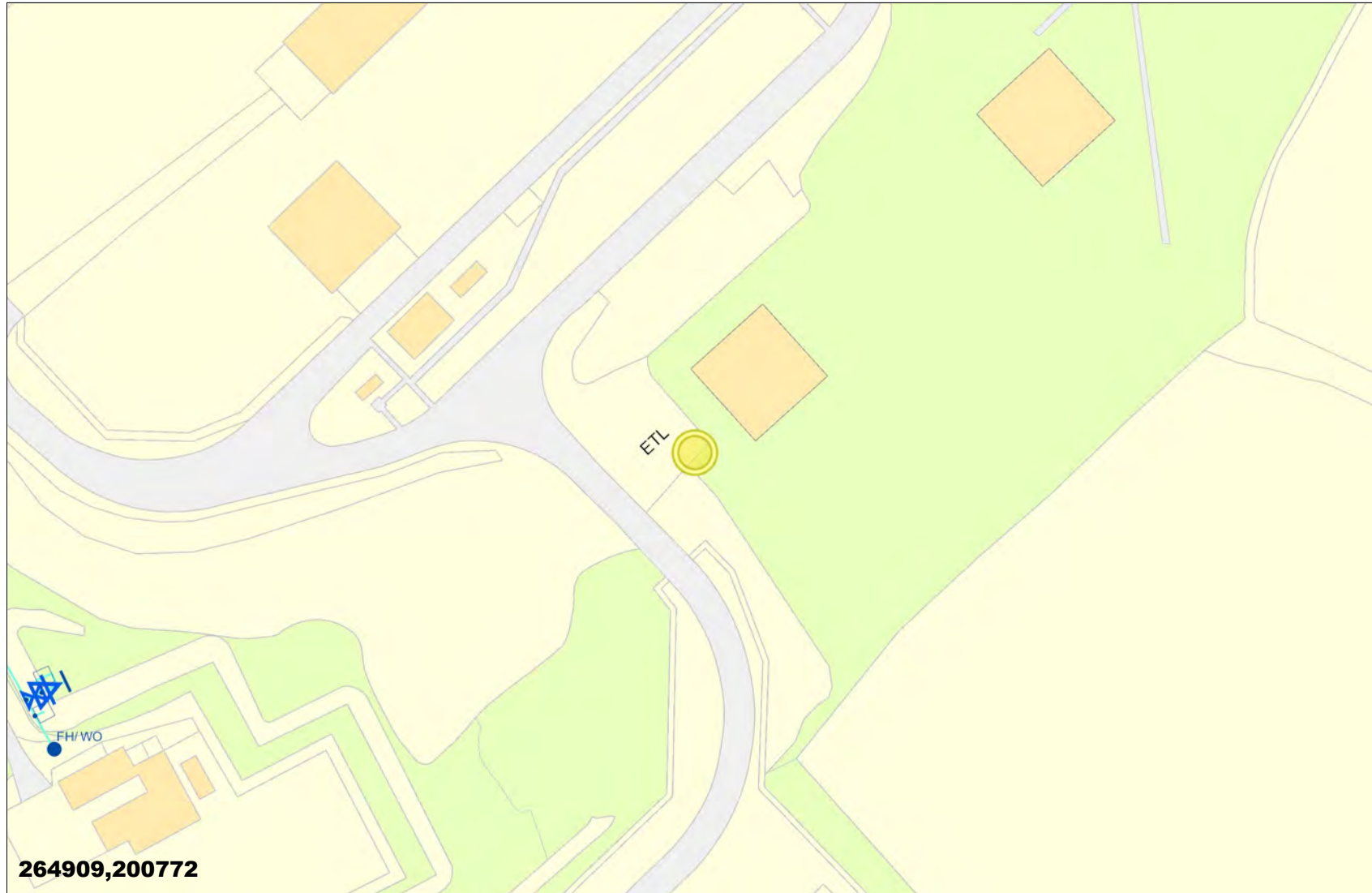







Whilst every reasonable effort has been taken to correctly record the pipe material of DCWW assets, there is a possibility that in some cases pipe material (other than Asbestos Cement or Pitch Fibre) may be found to be Asbestos Cement (AC) or Pitch Fibre (PF). It is therefore advisable that the possible presence of AC or PF pipes be anticipated and considered as part of any risk assessment prior to excavation.





**264909,200772**

**LEGEND**

**Clean Water**

-  Sluice Val
-  Air Val, SINGLE
-  Tap
-  Pressure Reducing Valve
-  Meter
-  BULK Meter
-  FH
-  Cap
-  Existing Main
-  NON COMPANY

**Sewerage External**

-  Foul
-  Surface Water
-  Combined
-  Rising Main
-  Private
-  Treatment Works
-  Pumping Station
-  Special Purpose
-  Unknown End
-  Change, Combined Overflow
-  Outfall, FOUL
-  Lamp Hole, Foul
-  Private Sewer Transfer
-  Lateral Drain
-  Inspection Chamber

Dwr Cymru Cyfyngedig ('the Company') gives this information as to the position of its underground apparatus by way of general guidance only and on the strict understanding that it is based on the best information available and no warranty as to its correctness is relied upon in the event of excavations or other works made in the vicinity of the company's apparatus and any onus of locating the apparatus before carrying out any excavations rests entirely on you. The information which is supplied hereby by the company, is done so in accordance with statutory requirements of sections 198 and 199 of the Water Industry Act 1991 based upon the best information available and in particular, but without prejudice to the generality of the foregoing, it should be noted that the records that are available to the Company may not disclose the existence of a drain sewer or disposal main laid before 1 September 1989, or if they do, the particulars thereof including their position underground may not be accurate. It must be understood that the furnishing of this information is entirely without prejudice to the provision of the New Roads and Street Works Act 1991 and the company's right to be compensated for any damage to its apparatus.

**EXACT LOCATION OF ALL APPARATUS TO BE DETERMINED ON SITE**





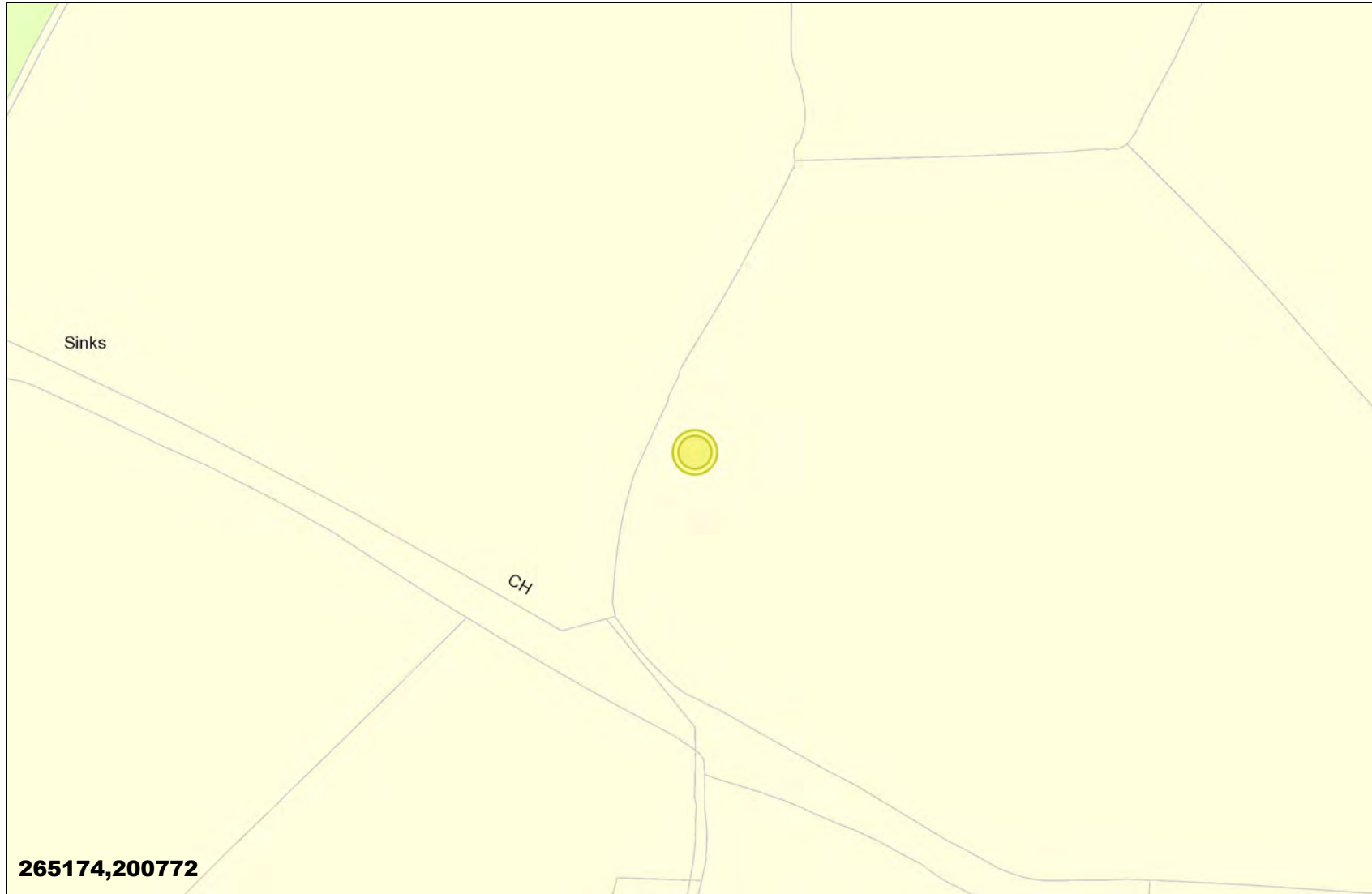





Reproduced from the Ordnance Survey's maps with the permission of the Controller of Her Majesty's Stationary Office. Crown Copyright. Licence No: WU298565.

Whilst every reasonable effort has been taken to correctly record the pipe material of DCWW assets, there is a possibility that in some cases pipe material (other than Asbestos Cement or Pitch Fibre) may be found to be Asbestos Cement (AC) or Pitch Fibre (PF). It is therefore advisable that the possible presence of AC or PF pipes be anticipated and considered as part of any risk assessment prior to excavation.













**LEGEND**

**Clean Water**

-  Sluice Val
-  Air Val, SINGLE
-  Tap
-  Pressure Reducing Valve
-  Meter
-  BULK Meter
-  FH
-  Cap
-  Existing Main
-  NON COMPANY

**Sewerage External**

-  Foul
-  Surface Water
-  Combined
-  Rising Main
-  Private
-  Treatment Works
-  Pumping Station
-  Special Purpose
-  Unknown End
-  Change, Combined Overflow
-  Outfall, FOUL
-  Lamp Hole, Foul
-  Private Sewer Transfer
-  Lateral Drain
-  Inspection Chamber

**265174,200772**

Dwr Cymru Cyfyngedig ('the Company') gives this information as to the position of its underground apparatus by way of general guidance only and on the strict understanding that it is based on the best information available and no warranty as to its correctness is relied upon. In the event of excavations or other works made in the vicinity of the company's apparatus and any onus of locating the apparatus before carrying out any excavations rests entirely on you. The information which is supplied hereby the company, is done so in accordance with statutory requirements of sections 198 and 199 of the water industry Act 1991 based upon the best information available and in particular, but without prejudice to the generality of the foregoing, it should be noted that the records that are available to the Company may not disclose the existence of a drain sewer or disposal main laid before 1 September 1989, or if they do, the particulars thereof including their position underground may not be accurate. It must be understood that the furnishing of this information is entirely without prejudice to the provision of the New Roads and Street Works Act 1991 and the company's right to be compensated for any damage to its apparatus.

**EXACT LOCATION OF ALL APPARATUS TO BE DETERMINED ON SITE**





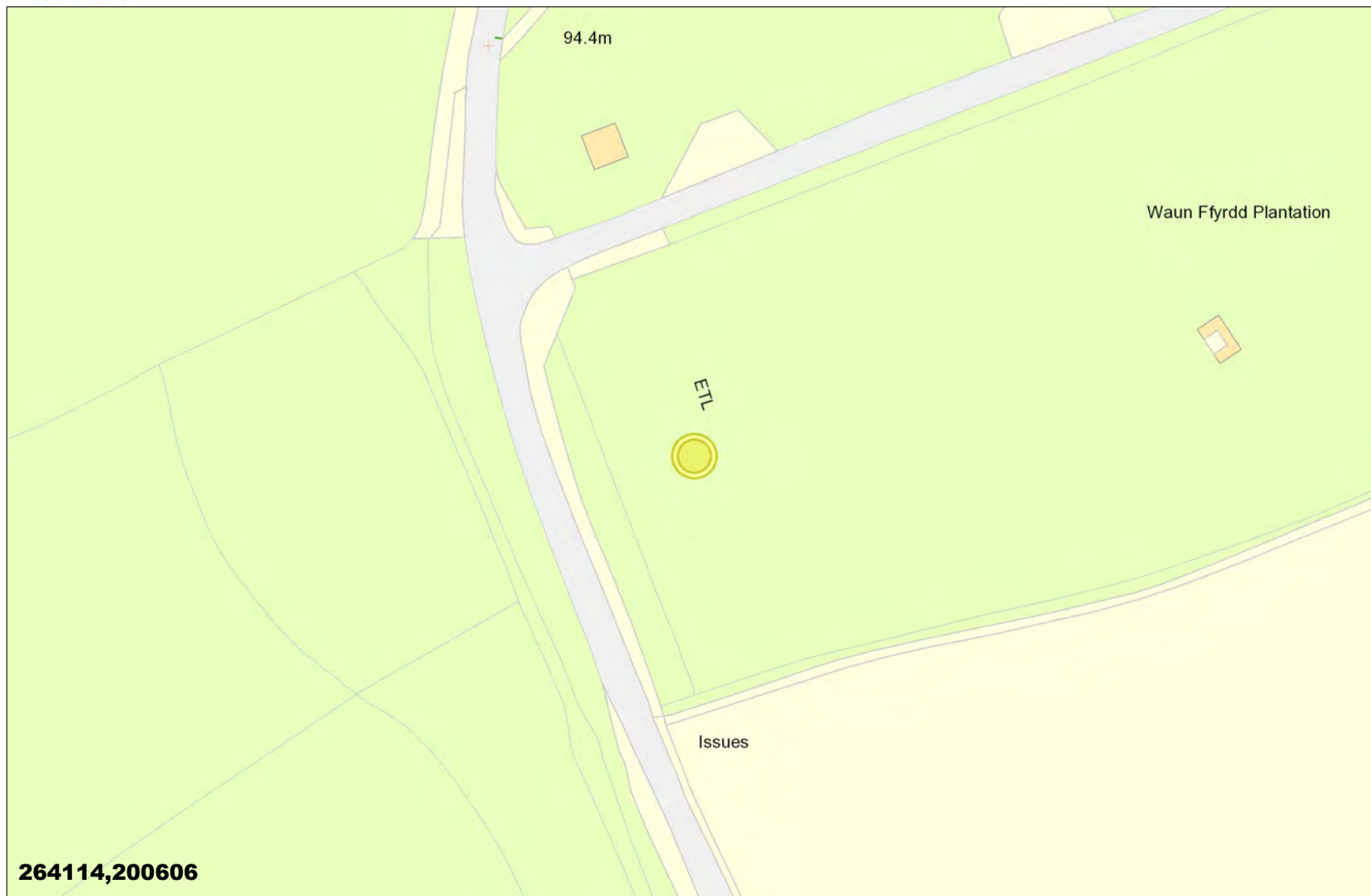





Reproduced from the Ordnance Survey's maps with the permission of the Controller of Her Majesty's Stationary Office. Crown Copyright. Licence No: WU298565.

Whilst every reasonable effort has been taken to correctly record the pipe material of DCWW assets, there is a possibility that in some cases pipe material (other than Asbestos Cement or Pitch Fibre) may be found to be Asbestos Cement (AC) or Pitch Fibre (PF). It is therefore advisable that the possible presence of AC or PF pipes be anticipated and considered as part of any risk assessment prior to excavation.



**LEGEND**

**Clean Water**

-  Sluice Val
-  Air Val, SINGLE
-  Tap
-  Pressure Reducing Valve
-  Meter
-  BULK Meter
-  FH
-  Cap
-  Existing Main
-  NON COMPANY

**Sewerage External**

-  Foul
-  Surface Water
-  Combined
-  Rising Main
-  Private
-  Treatment Works
-  Pumping Station
-  Special Purpose
-  Unknown End
-  Change, Combined Overflow
-  Outfall, FOUL
-  Lamp Hole, Foul
-  Private Sewer Transfer
-  Lateral Drain
-  Inspection Chamber

**264114,200606**

Dwr Cymru Cyfyngedig ('the Company') gives this information as to the position of its underground apparatus by way of general guidance only and on the strict understanding that it is based on the best information available and no warranty as to its correctness is relied upon in the event of excavations or other works made in the vicinity of the company's apparatus and any onus of locating the apparatus before carrying out any excavations rests entirely on you. The information which is supplied hereby by the company, is done so in accordance with statutory requirements of sections 198 and 199 of the water industry Act 1991 based upon the best information available and in particular, but without prejudice to the generality of the foregoing, it should be noted that the records that are available to the Company may not disclose the existence of a drain sewer or disposal main laid before 1 September 1989, or if they do, the particulars thereof including their position underground may not be accurate. It must be understood that the furnishing of this information is entirely without prejudice to the provision of the New Roads and Street Works Act 1991 and the company's right to be compensated for any damage to its apparatus.

**EXACT LOCATION OF ALL APPARATUS TO BE DETERMINED ON SITE**





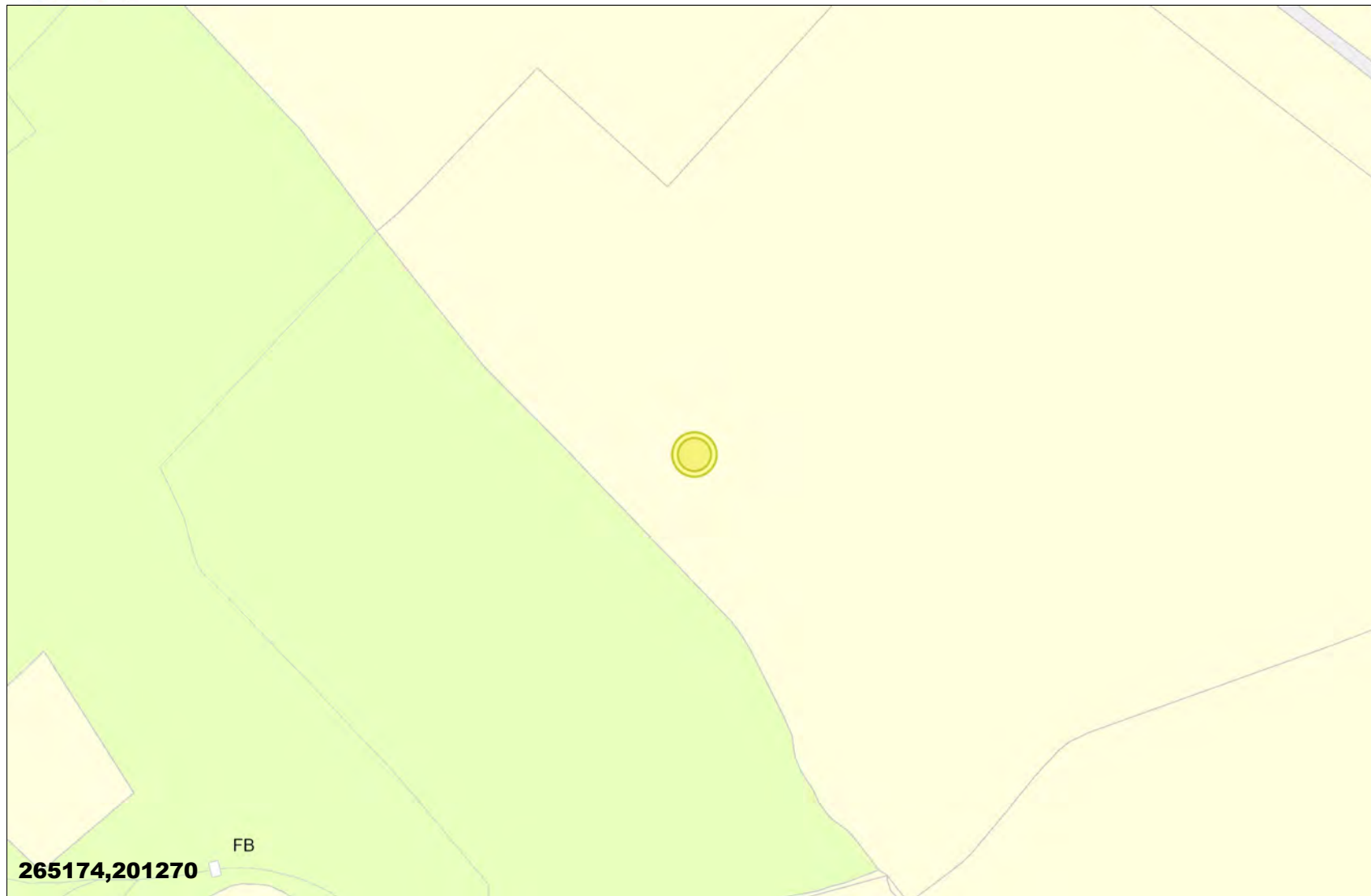



Reproduced from the Ordnance Survey's maps with the permission of the Controller of Her Majesty's Stationary Office. Crown Copyright. Licence No: WU298565.

Whilst every reasonable effort has been taken to correctly record the pipe material of DCWW assets, there is a possibility that in some cases pipe material (other than Asbestos Cement or Pitch Fibre) may be found to be Asbestos Cement (AC) or Pitch Fibre (PF). It is therefore advisable that the possible presence of AC or PF pipes be anticipated and considered as part of any risk assessment prior to excavation.



**LEGEND**

**Clean Water**

-  Sluice Val
-  Air Val, SINGLE
-  Tap
-  Pressure Reducing Valve
-  Meter
-  BULK Meter
-  FH
-  Cap

**Existing Main**

**NON COMPANY**

**Sewerage External**

-  Foul
-  Surface Water
-  Combined
-  Rising Main
-  Private
-  Treatment Works
-  Pumping Station
-  Special Purpose
-  Unknown End
-  Change, Combined Overflow
-  Outfall, FOUL
-  Lamp Hole, Foul
-  Private Sewer Transfer
-  Lateral Drain
-  Inspection Chamber

**265174,201270**

FB

Dwr Cymru Cyfyngedig ('the Company') gives this information as to the position of its underground apparatus by way of general guidance only and on the strict understanding that it is based on the best information available and no warranty as to its correctness is relied upon. In the event of excavations or other works made in the vicinity of the company's apparatus and any onus of locating the apparatus before carrying out any excavations rests entirely on you. The information which is supplied hereby the company, is done so in accordance with statutory requirements of sections 198 and 199 of the water industry Act 1991 based upon the best information available and in particular, but without prejudice to the generality of the foregoing, it should be noted that the records that are available to the Company may not disclose the existence of a drain sewer or disposal main laid before 1 September 1989, or if they do, the particulars thereof including their position underground may not be accurate. It must be understood that the furnishing of this information is entirely without prejudice to the provision of the New Roads and Street Works Act 1991 and the company's right to be compensated for any damage to its apparatus.

**EXACT LOCATION OF ALL APPARATUS TO BE DETERMINED ON SITE**

Reproduced from the Ordnance Survey's maps with the permission of the Controller of Her Majesty's Stationary Office. Crown Copyright. Licence No: WU298565.





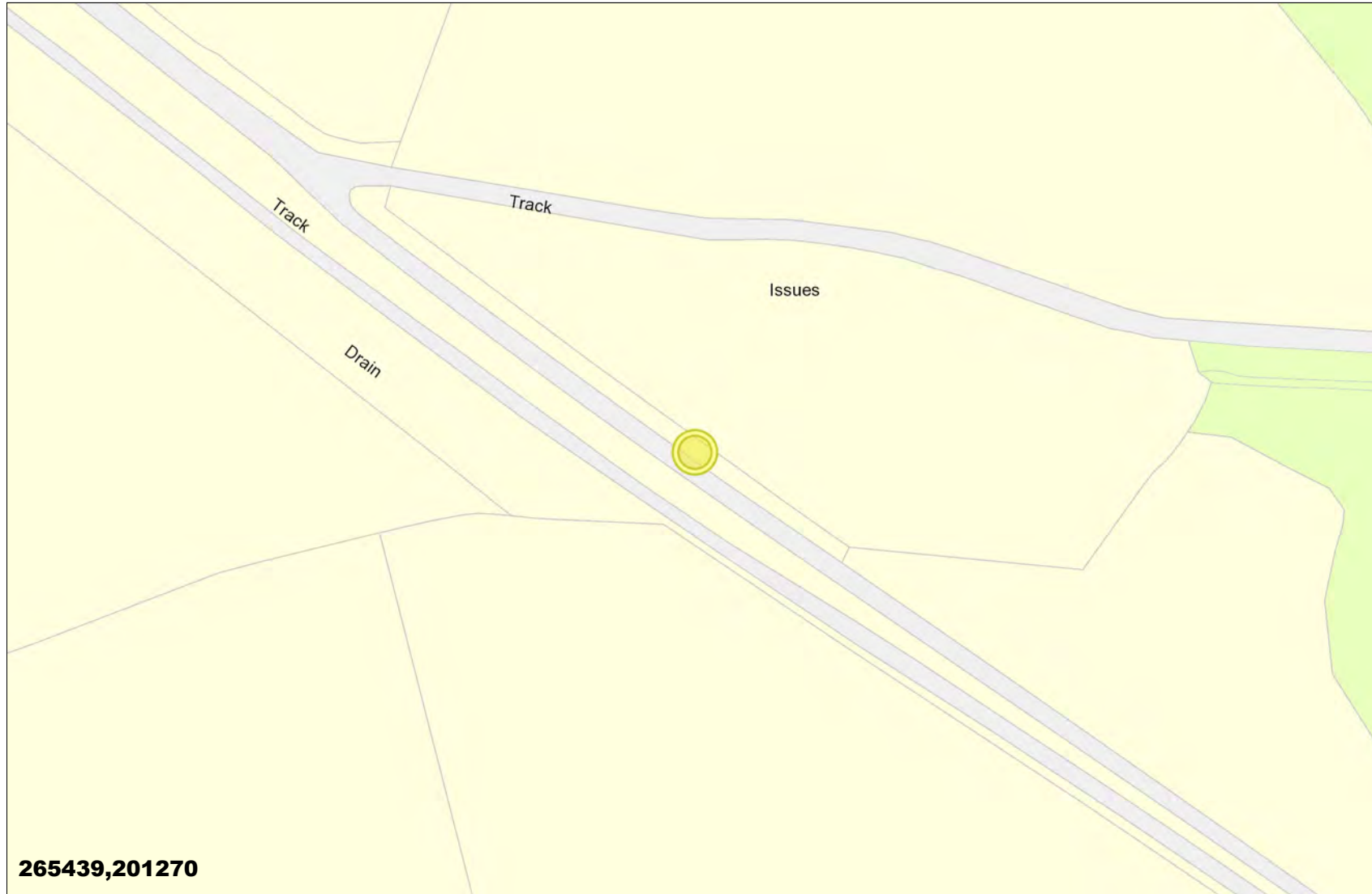





Whilst every reasonable effort has been taken to correctly record the pipe material of DCWW assets, there is a possibility that in some cases pipe material (other than Asbestos Cement or Pitch Fibre) may be found to be Asbestos Cement (AC) or Pitch Fibre (PF). It is therefore advisable that the possible presence of AC or PF pipes be anticipated and considered as part of any risk assessment prior to excavation.









**LEGEND**

**Clean Water**

-  Sluice Val
-  Air Val, SINGLE
-  Tap
-  Pressure Reducing Valve
-  Meter
-  BULK Meter
-  FH
-  Cap
-  Existing Main
-  NON COMPANY

**Sewerage External**

-  Foul
-  Surface Water
-  Combined
-  Rising Main
-  Private
-  Treatment Works
-  Pumping Station
-  Special Purpose
-  Unknown End
-  Change, Combined Overflow
-  Outfall, FOUL
-  Lamp Hole, Foul
-  Private Sewer Transfer
-  Lateral Drain
-  Inspection Chamber

265439,201270

Dwr Cymru Cyfyngedig ('the Company') gives this information as to the position of its underground apparatus by way of general guidance only and on the strict understanding that it is based on the best information available and no warranty as to its correctness is relied upon. In the event of excavations or other works made in the vicinity of the company's apparatus and any onus of locating the apparatus before carrying out any excavations rests entirely on you. The information which is supplied hereby the company, is done so in accordance with statutory requirements of sections 198 and 199 of the water industry Act 1991 based upon the best information available and in particular, but without prejudice to the generality of the foregoing, it should be noted that the records that are available to the Company may not disclose the existence of a drain sewer or disposal main laid before 1 September 1989, or if they do, the particulars thereof including their position underground may not be accurate. It must be understood that the furnishing of this information is entirely without prejudice to the provision of the New Roads and Street Works Act 1991 and the company's right to be compensated for any damage to its apparatus.

**EXACT LOCATION OF ALL APPARATUS TO BE DETERMINED ON SITE**





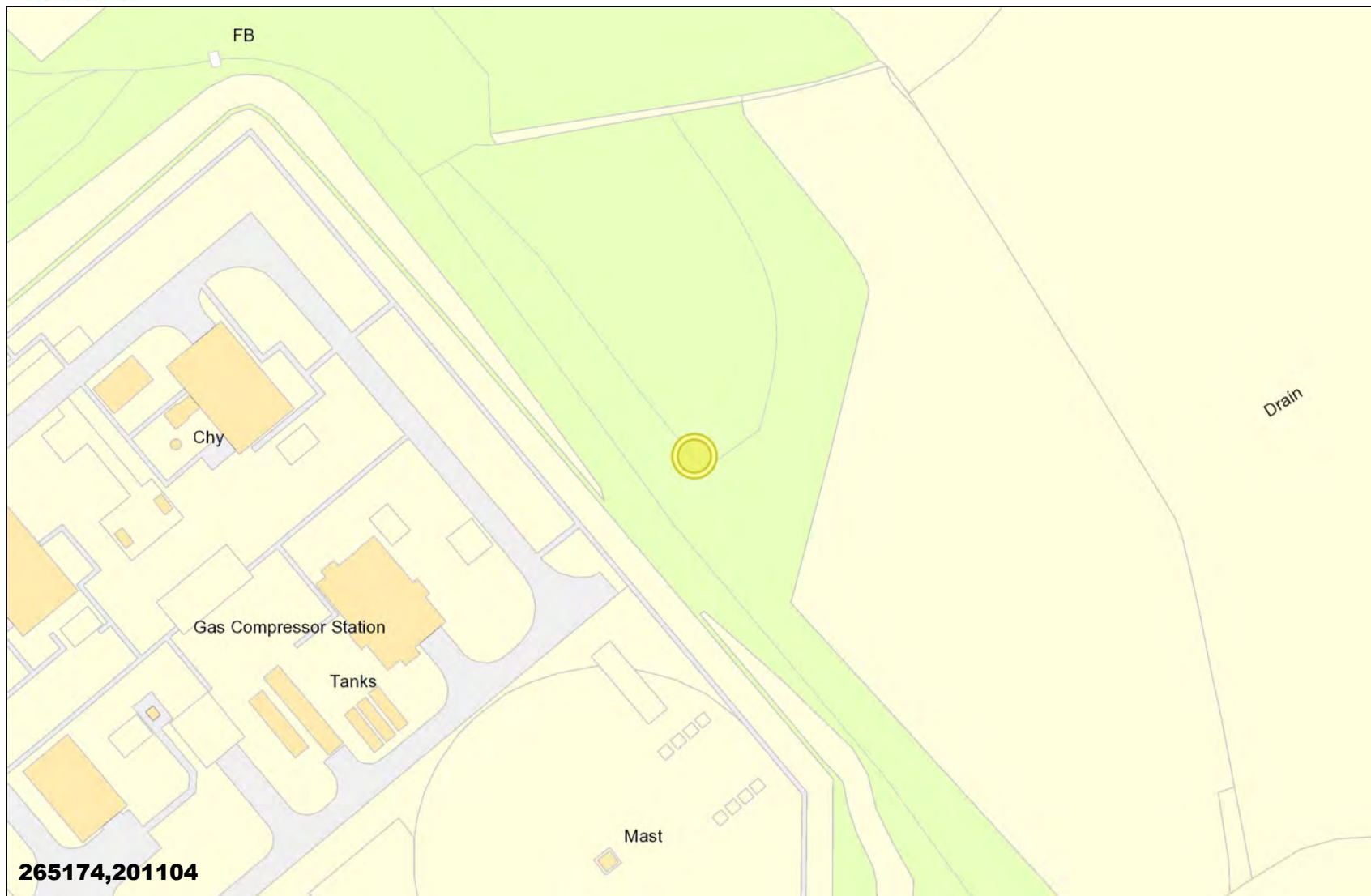



Reproduced from the Ordnance Survey's maps with the permission of the Controller of Her Majesty's Stationary Office. Crown Copyright. Licence No: WU298565.

Whilst every reasonable effort has been taken to correctly record the pipe material of DCWW assets, there is a possibility that in some cases pipe material (other than Asbestos Cement or Pitch Fibre) may be found to be Asbestos Cement (AC) or Pitch Fibre (PF). It is therefore advisable that the possible presence of AC or PF pipes be anticipated and considered as part of any risk assessment prior to excavation.



**LEGEND**

**Clean Water**

-  Sluice Val
-  Air Val, SINGLE
-  Tap
-  Pressure Reducing Valve
-  Meter
-  BULK Meter
-  FH
-  Cap

**Existing Main**

-  Existing Main
-  NON COMPANY

**Sewerage External**

-  Foul
-  Surface Water
-  Combined
-  Rising Main
-  Private
-  Treatment Works
-  Pumping Station
-  Special Purpose
-  Unknown End
-  Change, Combined Overflow
-  Outfall, FOUL
-  Lamp Hole, Foul
-  Private Sewer Transfer
-  Lateral Drain
-  Inspection Chamber

265174,201104

Dwr Cymru Cyfyngedig ('the Company') gives this information as to the position of its underground apparatus by way of general guidance only and on the strict understanding that it is based on the best information available and no warranty as to its correctness is relied upon in the event of excavations or other works made in the vicinity of the company's apparatus and any onus of locating the apparatus before carrying out any excavations rests entirely on you. The information which is supplied hereby by the company, is done so in accordance with statutory requirements of sections 198 and 199 of the water industry Act 1991 based upon the best information available and in particular, but without prejudice to the generality of the foregoing, it should be noted that the records that are available to the Company may not disclose the existence of a drain sewer or disposal main laid before 1 September 1989, or if they do, the particulars thereof including their position underground may not be accurate. It must be understood that the furnishing of this information is entirely without prejudice to the provision of the New Roads and Street Works Act 1991 and the company's right to be compensated for any damage to its apparatus.

**EXACT LOCATION OF ALL APPARATUS TO BE DETERMINED ON SITE**

Reproduced from the Ordnance Survey's maps with the permission of the Controller of Her Majesty's Stationary Office. Crown Copyright. Licence No: WU298565.

Whilst every reasonable effort has been taken to correctly record the pipe material of DCWW assets, there is a possibility that in some cases pipe material (other than Asbestos Cement or Pitch Fibre) may be found to be Asbestos Cement (AC) or Pitch Fibre (PF). It is therefore advisable that the possible presence of AC or PF pipes be anticipated and considered as part of any risk assessment prior to excavation.



265439,201104

**LEGEND**

**Clean Water**

-  Sluice Val
  -  Air Val, SINGLE
  -  Tap
  -  Pressure Reducing Valve
  -  Meter
  -  BULK Meter
  -  FH
  -  Cap
  -  Existing Main
  -  NON COMPANY
- Sewerage External**
-  Foul
  -  Surface Water
  -  Combined
  -  Rising Main
  -  Private
  -  Treatment Works
  -  Pumping Station
  -  Special Purpose
  -  Unknown End
  -  Change, Combined Overflow
  -  Outfall, FOUL
  -  Lamp Hole, Foul
  -  Private Sewer Transfer
  -  Lateral Drain
  -  Inspection Chamber

Dwr Cymru Cyfyngedig ('the Company') gives this information as to the position of its underground apparatus by way of general guidance only and on the strict understanding that it is based on the best information available and no warranty as to its correctness is relied upon. In the event of excavations or other works made in the vicinity of the company's apparatus and any onus of locating the apparatus before carrying out any excavations rests entirely on you. The information which is supplied hereby the company, is done so in accordance with statutory requirements of sections 198 and 199 of the water industry Act 1991 based upon the best information available and in particular, but without prejudice to the generality of the foregoing, it should be noted that the records that are available to the Company may not disclose the existence of a drain sewer or disposal main laid before 1 September 1989, or if they do, the particulars thereof including their position underground may not be accurate. It must be understood that the furnishing of this information is entirely without prejudice to the provision of the New Roads and Street Works Act 1991 and the company's right to be compensated for any damage to its apparatus.

**EXACT LOCATION OF ALL APPARATUS TO BE DETERMINED ON SITE**

Reproduced from the Ordnance Survey's maps with the permission of the Controller of Her Majesty's Stationary Office. Crown Copyright. Licence No: WU298565.



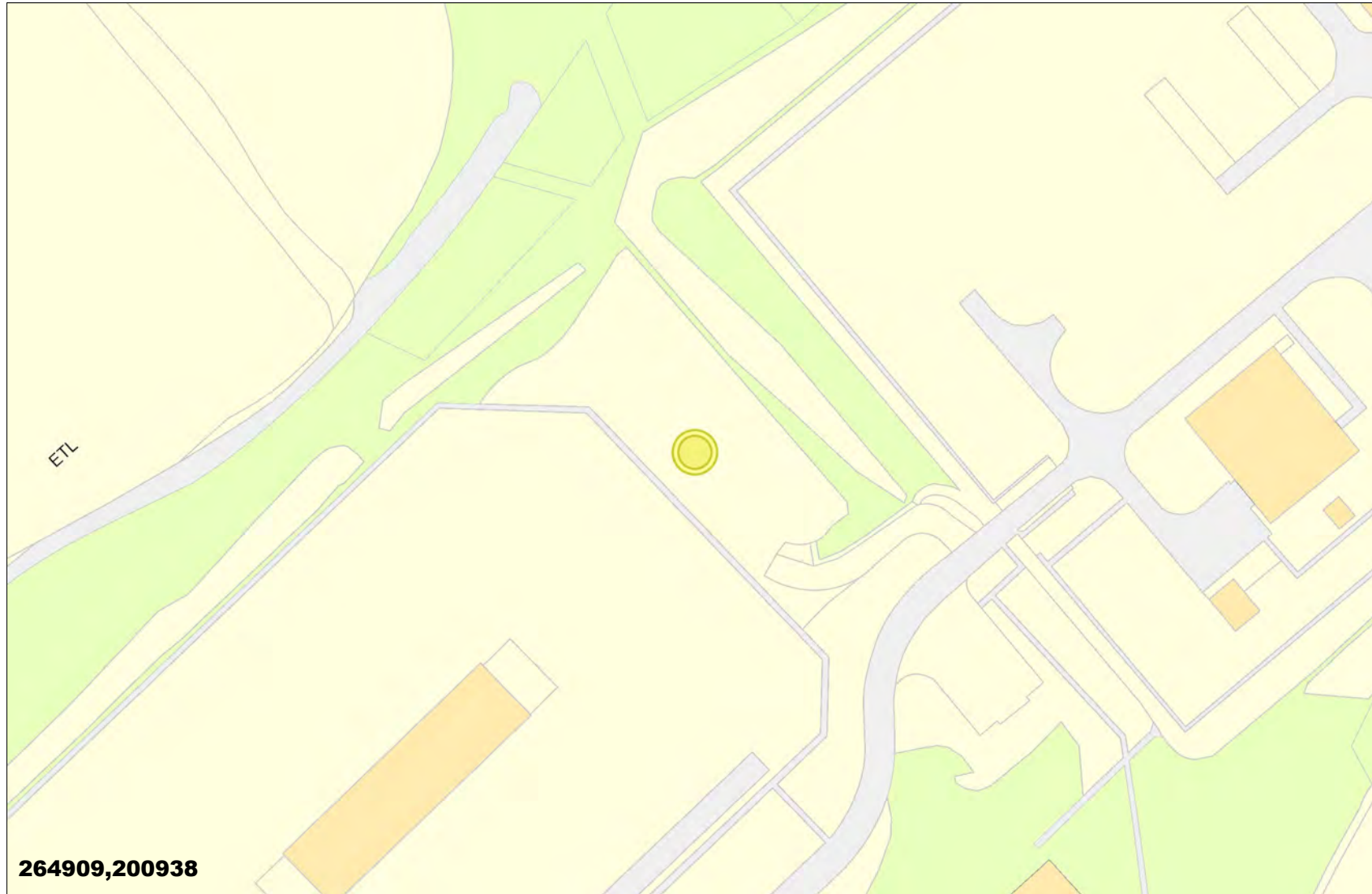



Whilst every reasonable effort has been taken to correctly record the pipe material of DCWW assets, there is a possibility that in some cases pipe material (other than Asbestos Cement or Pitch Fibre) may be found to be Asbestos Cement (AC) or Pitch Fibre (PF). It is therefore advisable that the possible presence of AC or PF pipes be anticipated and considered as part of any risk assessment prior to excavation.











264909,200938

**LEGEND**

**Clean Water**

-  Sluice Val
-  Air Val, SINGLE
-  Tap
-  Pressure Reducing Valve
-  Meter
-  BULK Meter
-  FH
-  Cap
-  Existing Main
-  NON COMPANY

**Sewerage External**

-  Foul
-  Surface Water
-  Combined
-  Rising Main
-  Private
-  Treatment Works
-  Pumping Station
-  Special Purpose
-  Unknown End
-  Change, Combined Overflow
-  Outfall, FOUL
-  Lamp Hole, Foul
-  Private Sewer Transfer
-  Lateral Drain
-  Inspection Chamber

Dwr Cymru Cyfyngedig ('the Company') gives this information as to the position of its underground apparatus by way of general guidance only and on the strict understanding that it is based on the best information available and no warranty as to its correctness is relied upon in the event of excavations or other works made in the vicinity of the company's apparatus and any onus of locating the apparatus before carrying out any excavations rests entirely on you. The information which is supplied hereby by the company, is done so in accordance with statutory requirements of sections 198 and 199 of the water industry Act 1991 based upon the best information available and in particular, but without prejudice to the generality of the foregoing, it should be noted that the records that are available to the Company may not disclose the existence of a drain sewer or disposal main laid before 1 September 1989, or if they do, the particulars thereof including their position underground may not be accurate. It must be understood that the furnishing of this information is entirely without prejudice to the provision of the New Roads and Street Works Act 1991 and the company's right to be compensated for any damage to its apparatus.

**EXACT LOCATION OF ALL APPARATUS TO BE DETERMINED ON SITE**





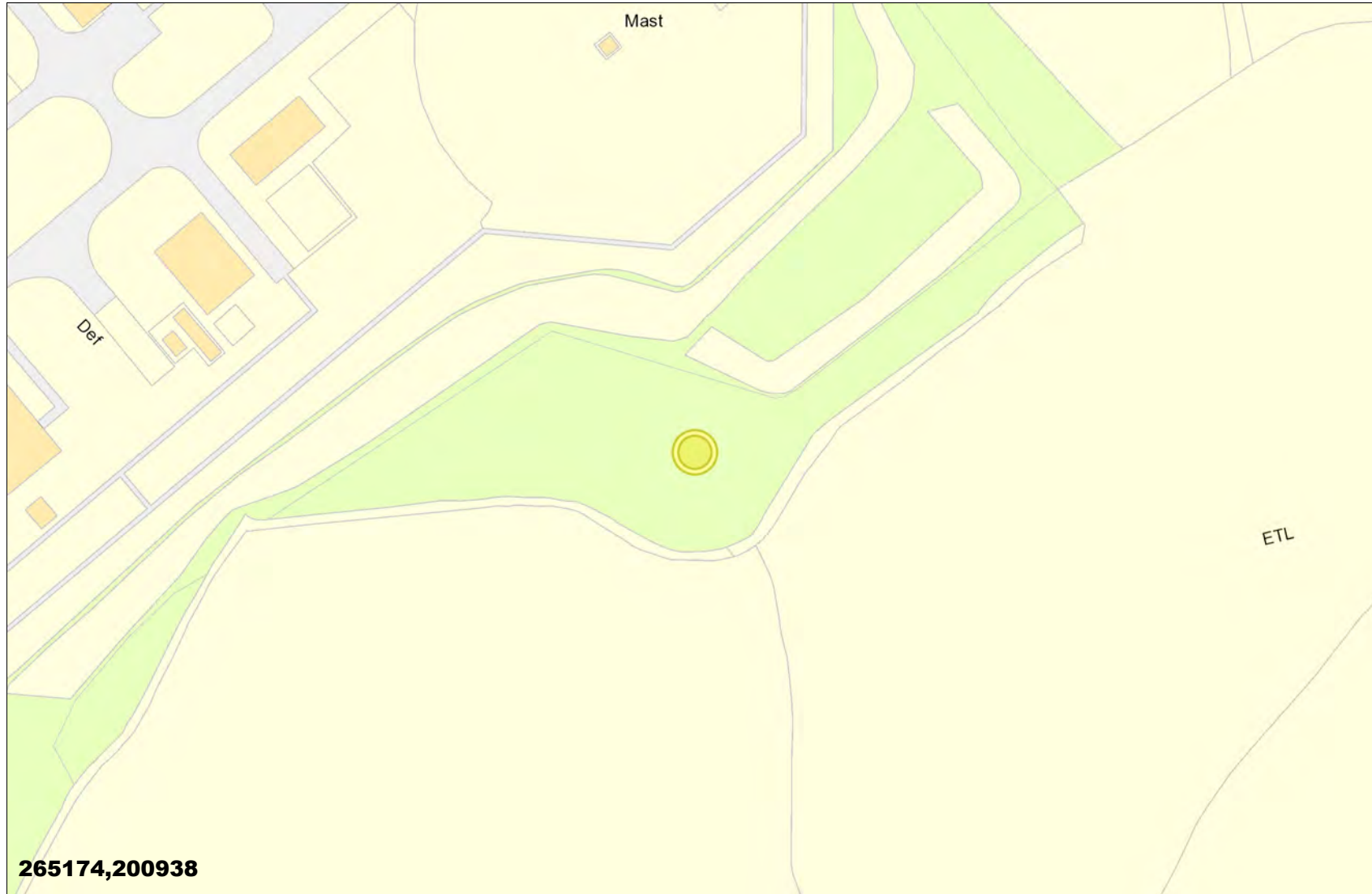

Reproduced from the Ordnance Survey's maps with the permission of the Controller of Her Majesty's Stationary Office. Crown Copyright. Licence No: WU298565.

Whilst every reasonable effort has been taken to correctly record the pipe material of DCWW assets, there is a possibility that in some cases pipe material (other than Asbestos Cement or Pitch Fibre) may be found to be Asbestos Cement (AC) or Pitch Fibre (PF). It is therefore advisable that the possible presence of AC or PF pipes be anticipated and considered as part of any risk assessment prior to excavation.













**LEGEND**

**Clean Water**

-  Sluice Val
-  Air Val, SINGLE
-  Tap
-  Pressure Reducing Valve
-  Meter
-  BULK Meter
-  FH
-  Cap
-  Existing Main
-  NON COMPANY

**Sewerage External**

-  Foul
-  Surface Water
-  Combined
-  Rising Main
-  Private
-  Treatment Works
-  Pumping Station
-  Special Purpose
-  Unknown End
-  Change, Combined Overflow
-  Outfall, FOUL
-  Lamp Hole, Foul
-  Private Sewer Transfer
-  Lateral Drain
-  Inspection Chamber

265174,200938

Dwr Cymru Cyfyngedig ('the Company') gives this information as to the position of its underground apparatus by way of general guidance only and on the strict understanding that it is based on the best information available and no warranty as to its correctness is relied upon in the event of excavations or other works made in the vicinity of the company's apparatus and any onus of locating the apparatus before carrying out any excavations rests entirely on you. The information which is supplied hereby by the company, is done so in accordance with statutory requirements of sections 198 and 199 of the water industry Act 1991 based upon the best information available and in particular, but without prejudice to the generality of the foregoing, it should be noted that the records that are available to the Company may not disclose the existence of a drain sewer or disposal main laid before 1 September 1989, or if they do, the particulars thereof including their position underground may not be accurate. It must be understood that the furnishing of this information is entirely without prejudice to the provision of the New Roads and Street Works Act 1991 and the company's right to be compensated for any damage to its apparatus.

**EXACT LOCATION OF ALL APPARATUS TO BE DETERMINED ON SITE**





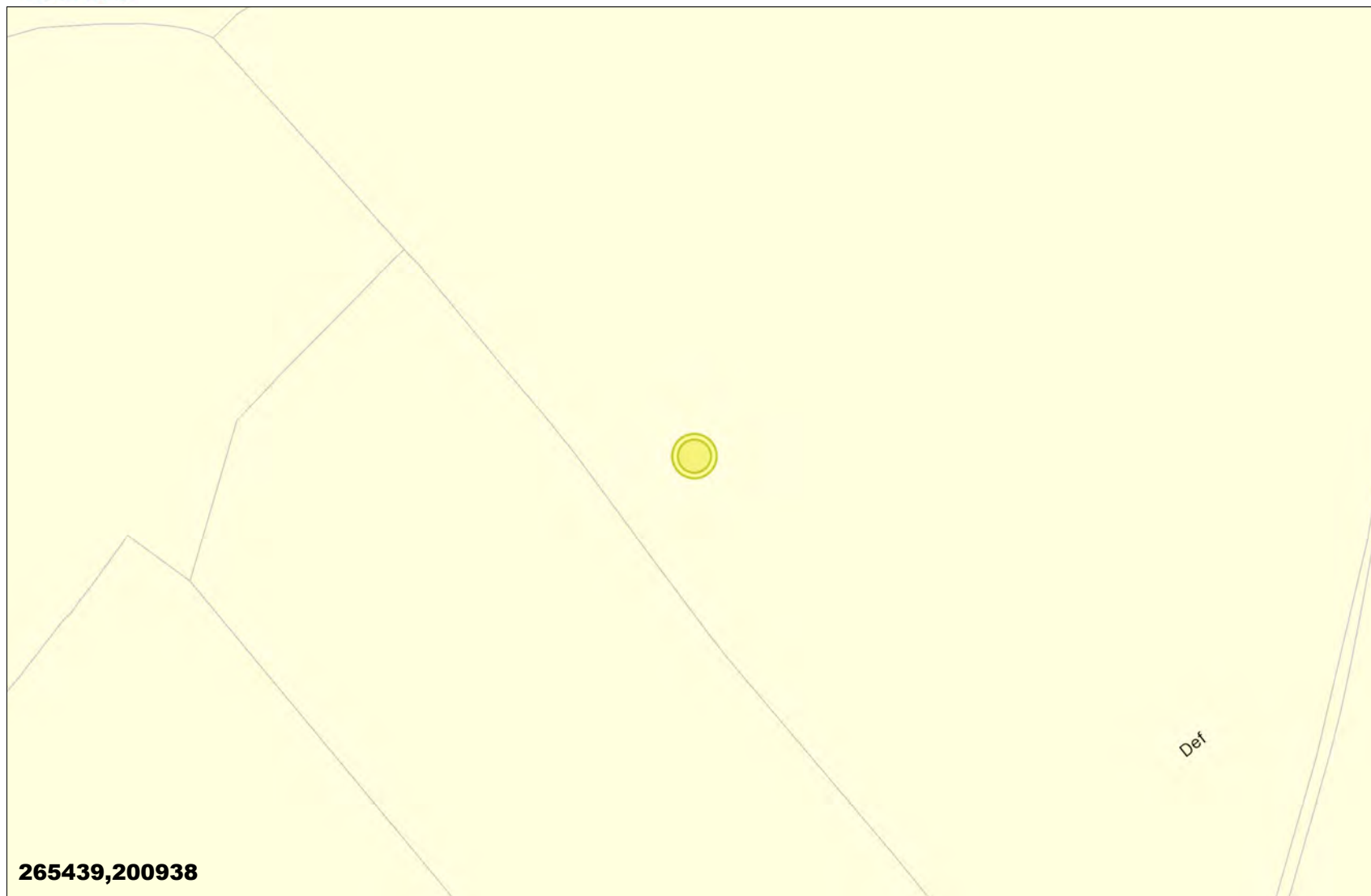



Reproduced from the Ordnance Survey's maps with the permission of the Controller of Her Majesty's Stationary Office. Crown Copyright. Licence No: WU298565.

Whilst every reasonable effort has been taken to correctly record the pipe material of DCWW assets, there is a possibility that in some cases pipe material (other than Asbestos Cement or Pitch Fibre) may be found to be Asbestos Cement (AC) or Pitch Fibre (PF). It is therefore advisable that the possible presence of AC or PF pipes be anticipated and considered as part of any risk assessment prior to excavation.



**LEGEND**

**Clean Water**

-  Sluice Val
-  Air Val, SINGLE
-  Tap
-  Pressure Reducing Valve
-  Meter
-  BULK Meter
-  FH
-  Cap

**Existing Main**

-  Existing Main
-  NON COMPANY

**Sewerage External**

-  Foul
-  Surface Water
-  Combined
-  Rising Main
-  Private
-  Treatment Works
-  Pumping Station
-  Special Purpose
-  Unknown End
-  Change, Combined Overflow
-  Outfall, FOUL
-  Lamp Hole, Foul
-  Private Sewer Transfer
-  Lateral Drain
-  Inspection Chamber

Dwr Cymru Cyfyngedig ('the Company') gives this information as to the position of its underground apparatus by way of general guidance only and on the strict understanding that it is based on the best information available and no warranty as to its correctness is relied upon. In the event of excavations or other works made in the vicinity of the company's apparatus and any onus of locating the apparatus before carrying out any excavations rests entirely on you. The information which is supplied hereby the company, is done so in accordance with statutory requirements of sections 198 and 199 of the water industry Act 1991 based upon the best information available and in particular, but without prejudice to the generality of the foregoing, it should be noted that the records that are available to the Company may not disclose the existence of a drain sewer or disposal main laid before 1 September 1989, or if they do, the particulars thereof including their position underground may not be accurate. It must be understood that the furnishing of this information is entirely without prejudice to the provision of the New Roads and Street Works Act 1991 and the company's right to be compensated for any damage to its apparatus.

**EXACT LOCATION OF ALL APPARATUS TO BE DETERMINED ON SITE**





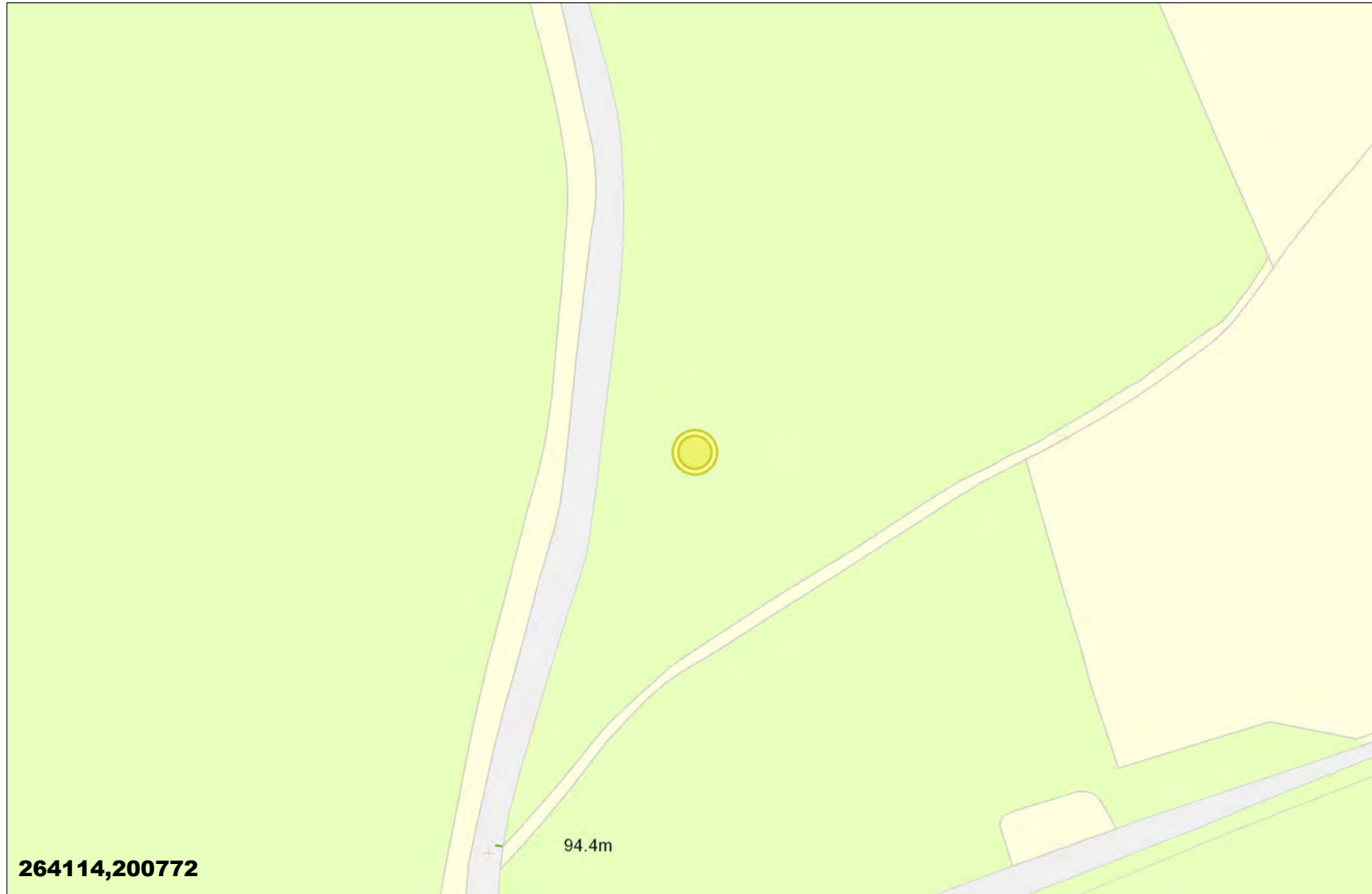



Reproduced from the Ordnance Survey's maps with the permission of the Controller of Her Majesty's Stationary Office. Crown Copyright. Licence No: WU298565.

Whilst every reasonable effort has been taken to correctly record the pipe material of DCWW assets, there is a possibility that in some cases pipe material (other than Asbestos Cement or Pitch Fibre) may be found to be Asbestos Cement (AC) or Pitch Fibre (PF). It is therefore advisable that the possible presence of AC or PF pipes be anticipated and considered as part of any risk assessment prior to excavation.



**LEGEND**















**Clean Water**

-  Sluice Val
-  Air Val, SINGLE
-  Tap
-  Pressure Reducing Valve
-  Meter
-  BULK Meter
-  FH
-  Cap

**Existing Main**

-  Existing Main
-  NON COMPANY

**Sewerage External**

-  Foul
-  Surface Water
-  Combined
-  Rising Main
-  Private
-  Treatment Works
-  Pumping Station
-  Special Purpose
-  Unknown End
-  Change, Combined Overflow
-  Outfall, FOUL
-  Lamp Hole, Foul
-  Private Sewer Transfer
-  Lateral Drain
-  Inspection Chamber

Dwr Cymru Cyfyngedig ('the Company') gives this information as to the position of its underground apparatus by way of general guidance only and on the strict understanding that it is based on the best information available and no warranty as to its correctness is relied upon. In the event of excavations or other works made in the vicinity of the company's apparatus and any onus of locating the apparatus before carrying out any excavations rests entirely on you. The information which is supplied hereby the company, is done so in accordance with statutory requirements of sections 198 and 199 of the water industry Act 1991 based upon the best information available and in particular, but without prejudice to the generality of the foregoing, it should be noted that the records that are available to the Company may not disclose the existence of a drain sewer or disposal main laid before 1 September 1989, or if they do, the particulars thereof including their position underground may not be accurate. It must be understood that the furnishing of this information is entirely without prejudice to the provision of the New Roads and Street Works Act 1991 and the company's right to be compensated for any damage to its apparatus.

**EXACT LOCATION OF ALL APPARATUS TO BE DETERMINED ON SITE**

Reproduced from the Ordnance Survey's maps with the permission of the Controller of Her Majesty's Stationary Office. Crown Copyright. Licence No: WU298565.



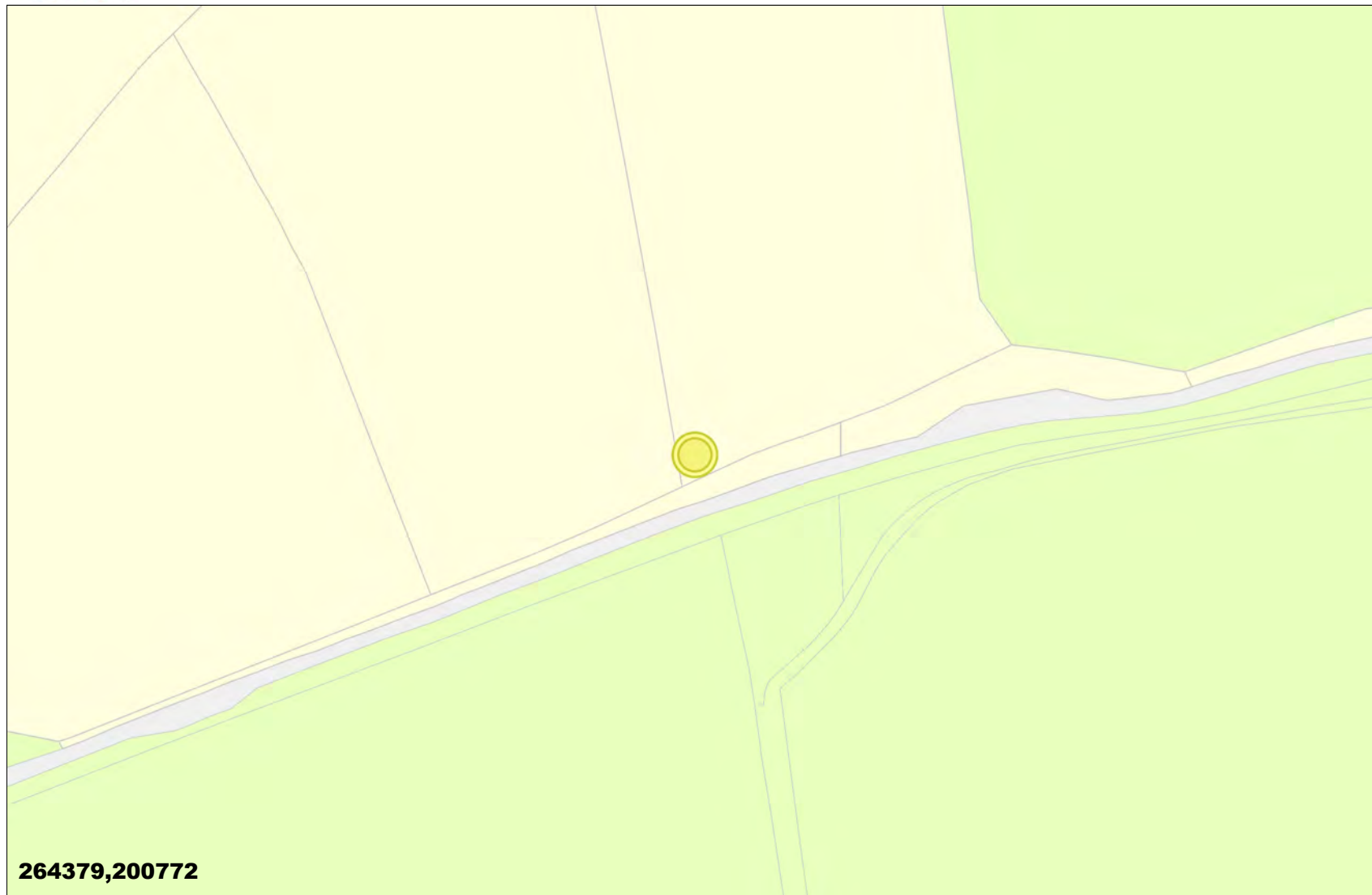





Whilst every reasonable effort has been taken to correctly record the pipe material of DCWW assets, there is a possibility that in some cases pipe material (other than Asbestos Cement or Pitch Fibre) may be found to be Asbestos Cement (AC) or Pitch Fibre (PF). It is therefore advisable that the possible presence of AC or PF pipes be anticipated and considered as part of any risk assessment prior to excavation.



264379,200772

**LEGEND**

**Clean Water**

-  Sluice Val
-  Air Val, SINGLE
-  Tap
-  Pressure Reducing Valve
-  Meter
-  BULK Meter
-  FH
-  Cap

**Existing Main**

-  Existing Main
-  NON COMPANY

**Sewerage External**

-  Foul
-  Surface Water
-  Combined
-  Rising Main
-  Private
-  Treatment Works
-  Pumping Station
-  Special Purpose
-  Unknown End
-  Change, Combined Overflow
-  Outfall, FOUL
-  Lamp Hole, Foul
-  Private Sewer Transfer
-  Lateral Drain
-  Inspection Chamber

Dwr Cymru Cyfyngedig ('the Company') gives this information as to the position of its underground apparatus by way of general guidance only and on the strict understanding that it is based on the best information available and no warranty as to its correctness is relied upon. In the event of excavations or other works made in the vicinity of the company's apparatus and any onus of locating the apparatus before carrying out any excavations rests entirely on you. The information which is supplied hereby the company, is done so in accordance with statutory requirements of sections 198 and 199 of the water industry Act 1991 based upon the best information available and in particular, but without prejudice to the generality of the foregoing, it should be noted that the records that are available to the Company may not disclose the existence of a drain sewer or disposal main laid before 1 September 1989, or if they do, the particulars thereof including their position underground may not be accurate. It must be understood that the furnishing of this information is entirely without prejudice to the provision of the New Roads and Street Works Act 1991 and the company's right to be compensated for any damage to its apparatus.

**EXACT LOCATION OF ALL APPARATUS TO BE DETERMINED ON SITE**

Reproduced from the Ordnance Survey's maps with the permission of the Controller of Her Majesty's Stationary Office. Crown Copyright. Licence No: WU298565.



Whilst every reasonable effort has been taken to correctly record the pipe material of DCWW assets, there is a possibility that in some cases pipe material (other than Asbestos Cement or Pitch Fibre) may be found to be Asbestos Cement (AC) or Pitch Fibre (PF). It is therefore advisable that the possible presence of AC or PF pipes be anticipated and considered as part of any risk assessment prior to excavation.

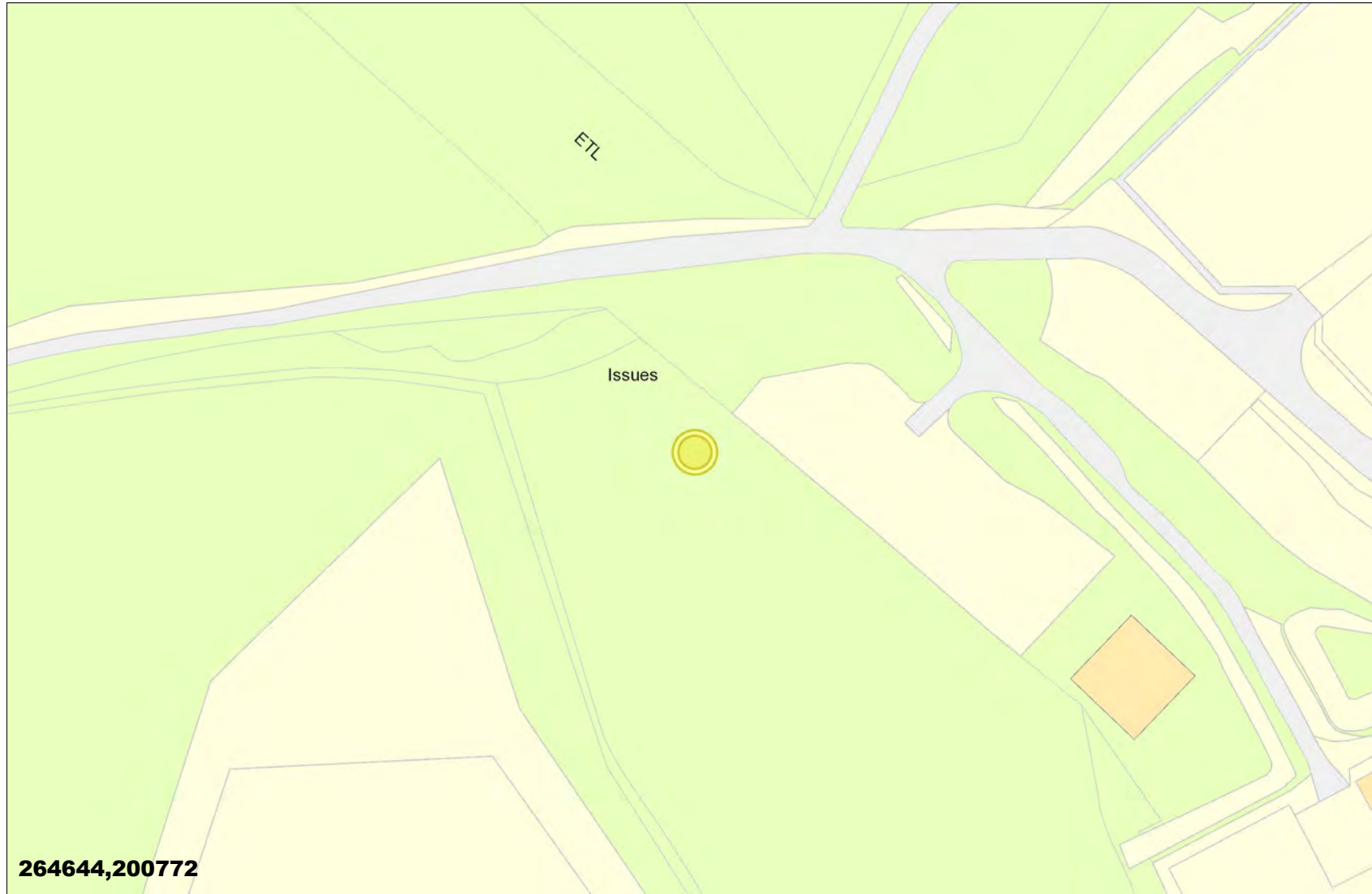

















**LEGEND**

**Clean Water**

-  Sluice Val
-  Air Val, SINGLE
-  Tap
-  Pressure Reducing Valve
-  Meter
-  BULK Meter
-  FH
-  Cap
-  Existing Main
-  NON COMPANY

**Sewerage External**

-  Foul
-  Surface Water
-  Combined
-  Rising Main
-  Private
-  Treatment Works
-  Pumping Station
-  Special Purpose
-  Unknown End
-  Change, Combined Overflow
-  Outfall, FOUL
-  Lamp Hole, Foul
-  Private Sewer Transfer
-  Lateral Drain
-  Inspection Chamber

264644,200772

Dwr Cymru Cyfyngedig ('the Company') gives this information as to the position of its underground apparatus by way of general guidance only and on the strict understanding that it is based on the best information available and no warranty as to its correctness is relied upon. In the event of excavations or other works made in the vicinity of the company's apparatus and any onus of locating the apparatus before carrying out any excavations rests entirely on you. The information which is supplied hereby the company, is done so in accordance with statutory requirements of sections 198 and 199 of the water industry Act 1991 based upon the best information available and in particular, but without prejudice to the generality of the foregoing, it should be noted that the records that are available to the Company may not disclose the existence of a drain sewer or disposal main laid before 1 September 1989, or if they do, the particulars thereof including their position underground may not be accurate. It must be understood that the furnishing of this information is entirely without prejudice to the provision of the New Roads and Street Works Act 1991 and the company's right to be compensated for any damage to its apparatus.

**EXACT LOCATION OF ALL APPARATUS TO BE DETERMINED ON SITE**





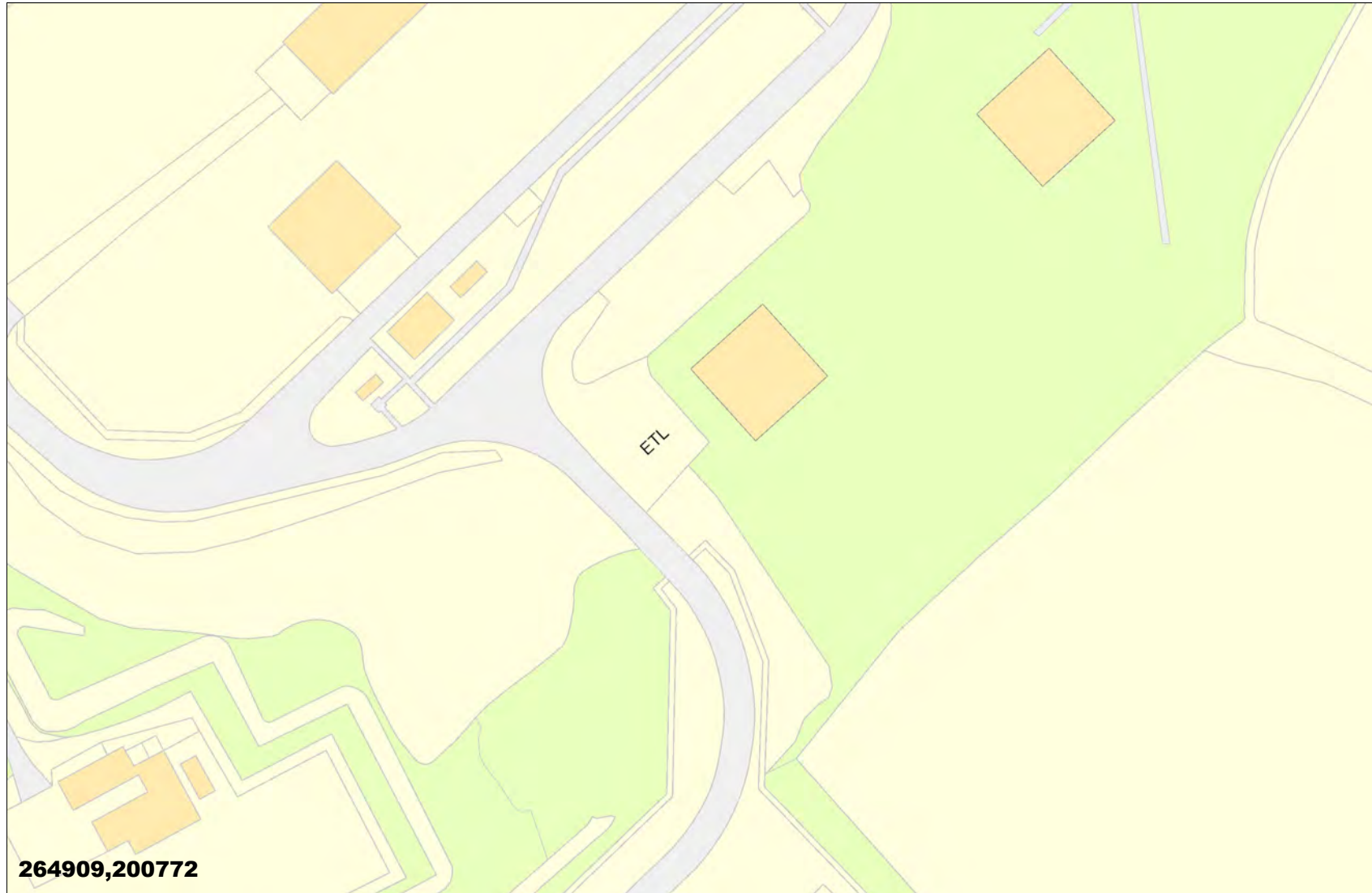



Reproduced from the Ordnance Survey's maps with the permission of the Controller of Her Majesty's Stationary Office. Crown Copyright. Licence No: WU298565.

Whilst every reasonable effort has been taken to correctly record the pipe material of DCWW assets, there is a possibility that in some cases pipe material (other than Asbestos Cement or Pitch Fibre) may be found to be Asbestos Cement (AC) or Pitch Fibre (PF). It is therefore advisable that the possible presence of AC or PF pipes be anticipated and considered as part of any risk assessment prior to excavation.



**LEGEND**















**Clean Water**

-  Sluice Val
-  Air Val, SINGLE
-  Tap
-  Pressure Reducing Valve
-  Meter
-  BULK Meter
-  FH
-  Cap

**Existing Main**

-  Existing Main
-  NON COMPANY

**Sewerage External**

-  Foul
-  Surface Water
-  Combined
-  Rising Main
-  Private
-  Treatment Works
-  Pumping Station
-  Special Purpose
-  Unknown End
-  Change, Combined Overflow
-  Outfall, FOUL
-  Lamp Hole, Foul
-  Private Sewer Transfer
-  Lateral Drain
-  Inspection Chamber

264909,200772

Dwr Cymru Cyfyngedig ('the Company') gives this information as to the position of its underground apparatus by way of general guidance only and on the strict understanding that it is based on the best information available and no warranty as to its correctness is relied upon in the event of excavations or other works made in the vicinity of the company's apparatus and any onus of locating the apparatus before carrying out any excavations rests entirely on you. The information which is supplied hereby by the company, is done so in accordance with statutory requirements of sections 198 and 199 of the Water Industry Act 1991 based upon the best information available and in particular, but without prejudice to the generality of the foregoing, it should be noted that the records that are available to the Company may not disclose the existence of a drain sewer or disposal main laid before 1 September 1989, or if they do, the particulars thereof including their position underground may not be accurate. It must be understood that the furnishing of this information is entirely without prejudice to the provision of the New Roads and Street Works Act 1991 and the company's right to be compensated for any damage to its apparatus.

**EXACT LOCATION OF ALL APPARATUS TO BE DETERMINED ON SITE**

Reproduced from the Ordnance Survey's maps with the permission of the Controller of Her Majesty's Stationary Office. Crown Copyright. Licence No: WU298565.

Whilst every reasonable effort has been taken to correctly record the pipe material of DCWW assets, there is a possibility that in some cases pipe material (other than Asbestos Cement or Pitch Fibre) may be found to be Asbestos Cement (AC) or Pitch Fibre (PF). It is therefore advisable that the possible presence of AC or PF pipes be anticipated and considered as part of any risk assessment prior to excavation.

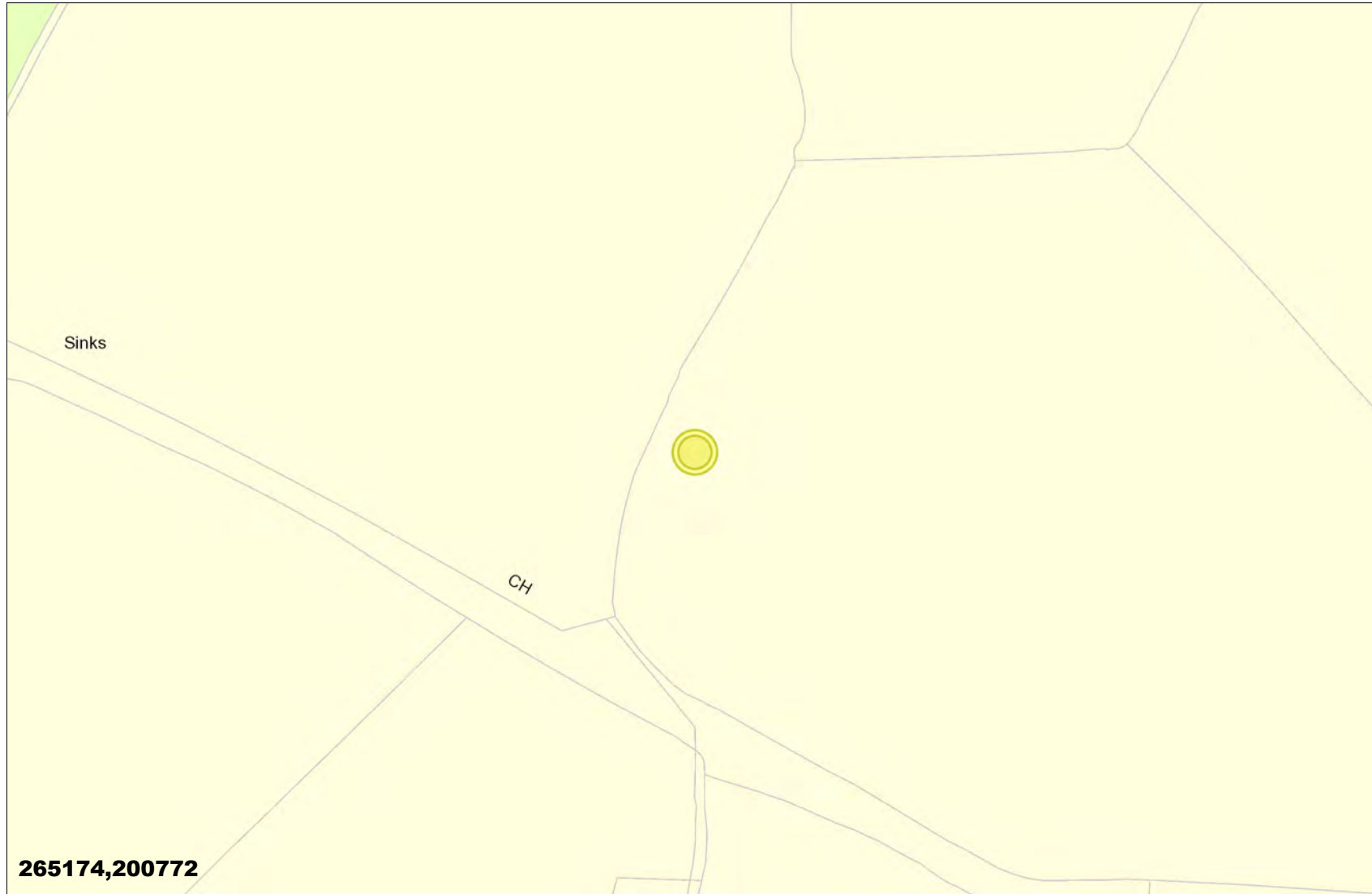















**LEGEND**

**Clean Water**

-  Sluice Val
-  Air Val, SINGLE
-  Tap
-  Pressure Reducing Valve
-  Meter
-  BULK Meter
-  FH
-  Cap
-  Existing Main
-  NON COMPANY

**Sewerage External**

-  Foul
-  Surface Water
-  Combined
-  Rising Main
-  Private
-  Treatment Works
-  Pumping Station
-  Special Purpose
-  Unknown End
-  Change, Combined Overflow
-  Outfall, FOUL
-  Lamp Hole, Foul
-  Private Sewer Transfer
-  Lateral Drain
-  Inspection Chamber

265174,200772

Dwr Cymru Cyfyngedig ('the Company') gives this information as to the position of its underground apparatus by way of general guidance only and on the strict understanding that it is based on the best information available and no warranty as to its correctness is relied upon. In the event of excavations or other works made in the vicinity of the company's apparatus and any onus of locating the apparatus before carrying out any excavations rests entirely on you. The information which is supplied hereby the company, is done so in accordance with statutory requirements of sections 198 and 199 of the water industry Act 1991 based upon the best information available and in particular, but without prejudice to the generality of the foregoing, it should be noted that the records that are available to the Company may not disclose the existence of a drain sewer or disposal main laid before 1 September 1989, or if they do, the particulars thereof including their position underground may not be accurate. It must be understood that the furnishing of this information is entirely without prejudice to the provision of the New Roads and Street Works Act 1991 and the company's right to be compensated for any damage to its apparatus.

**EXACT LOCATION OF ALL APPARATUS TO BE DETERMINED ON SITE**





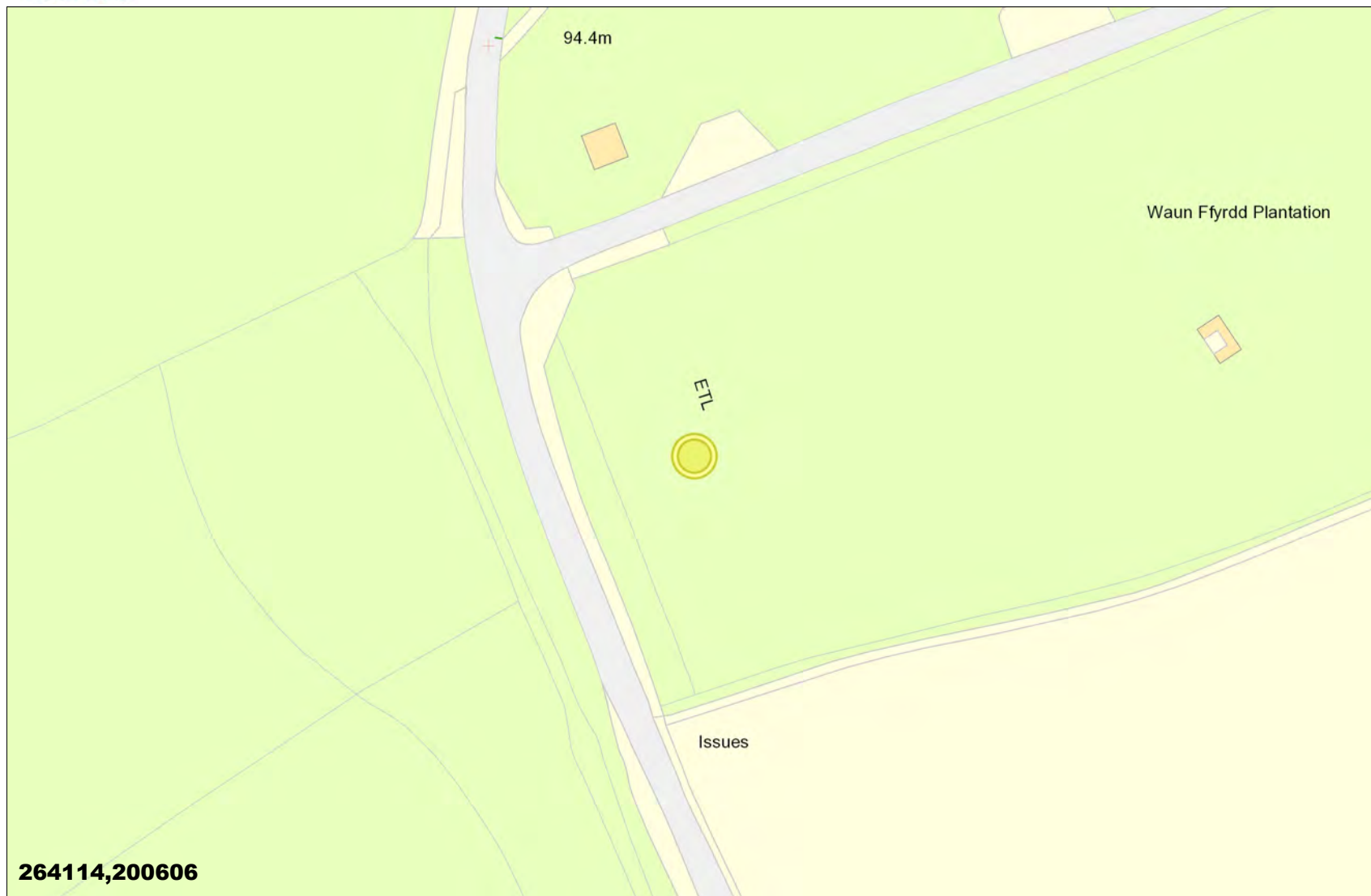



Reproduced from the Ordnance Survey's maps with the permission of the Controller of Her Majesty's Stationary Office. Crown Copyright. Licence No: WU298565.

Whilst every reasonable effort has been taken to correctly record the pipe material of DCWW assets, there is a possibility that in some cases pipe material (other than Asbestos Cement or Pitch Fibre) may be found to be Asbestos Cement (AC) or Pitch Fibre (PF). It is therefore advisable that the possible presence of AC or PF pipes be anticipated and considered as part of any risk assessment prior to excavation.



**LEGEND**

**Clean Water**

-  Sluice Val
-  Air Val, SINGLE
-  Tap
-  Pressure Reducing Valve
-  Meter
-  BULK Meter
-  FH
-  Cap
-  Existing Main
-  NON COMPANY

**Sewerage External**

-  Foul
-  Surface Water
-  Combined
-  Rising Main
-  Private
-  Treatment Works
-  Pumping Station
-  Special Purpose
-  Unknown End
-  Change, Combined Overflow
-  Outfall, FOUL
-  Lamp Hole, Foul
-  Private Sewer Transfer
-  Lateral Drain
-  Inspection Chamber

**264114,200606**

Dwr Cymru Cyfyngedig ('the Company') gives this information as to the position of its underground apparatus by way of general guidance only and on the strict understanding that it is based on the best information available and no warranty as to its correctness is relied upon. In the event of excavations or other works made in the vicinity of the company's apparatus and any onus of locating the apparatus before carrying out any excavations rests entirely on you. The information which is supplied hereby by the company, is done so in accordance with statutory requirements of sections 198 and 199 of the water industry Act 1991 based upon the best information available and in particular, but without prejudice to the generality of the foregoing, it should be noted that the records that are available to the Company may not disclose the existence of a drain sewer or disposal main laid before 1 September 1989, or if they do, the particulars thereof including their position underground may not be accurate. It must be understood that the furnishing of this information is entirely without prejudice to the provision of the New Roads and Street Works Act 1991 and the company's right to be compensated for any damage to its apparatus.

**EXACT LOCATION OF ALL APPARATUS TO BE DETERMINED ON SITE**

Reproduced from the Ordnance Survey's maps with the permission of the Controller of Her Majesty's Stationary Office. Crown Copyright. Licence No: WU298565.

Whilst every reasonable effort has been taken to correctly record the pipe material of DCWW assets, there is a possibility that in some cases pipe material (other than Asbestos Cement or Pitch Fibre) may be found to be Asbestos Cement (AC) or Pitch Fibre (PF). It is therefore advisable that the possible presence of AC or PF pipes be anticipated and considered as part of any risk assessment prior to excavation.

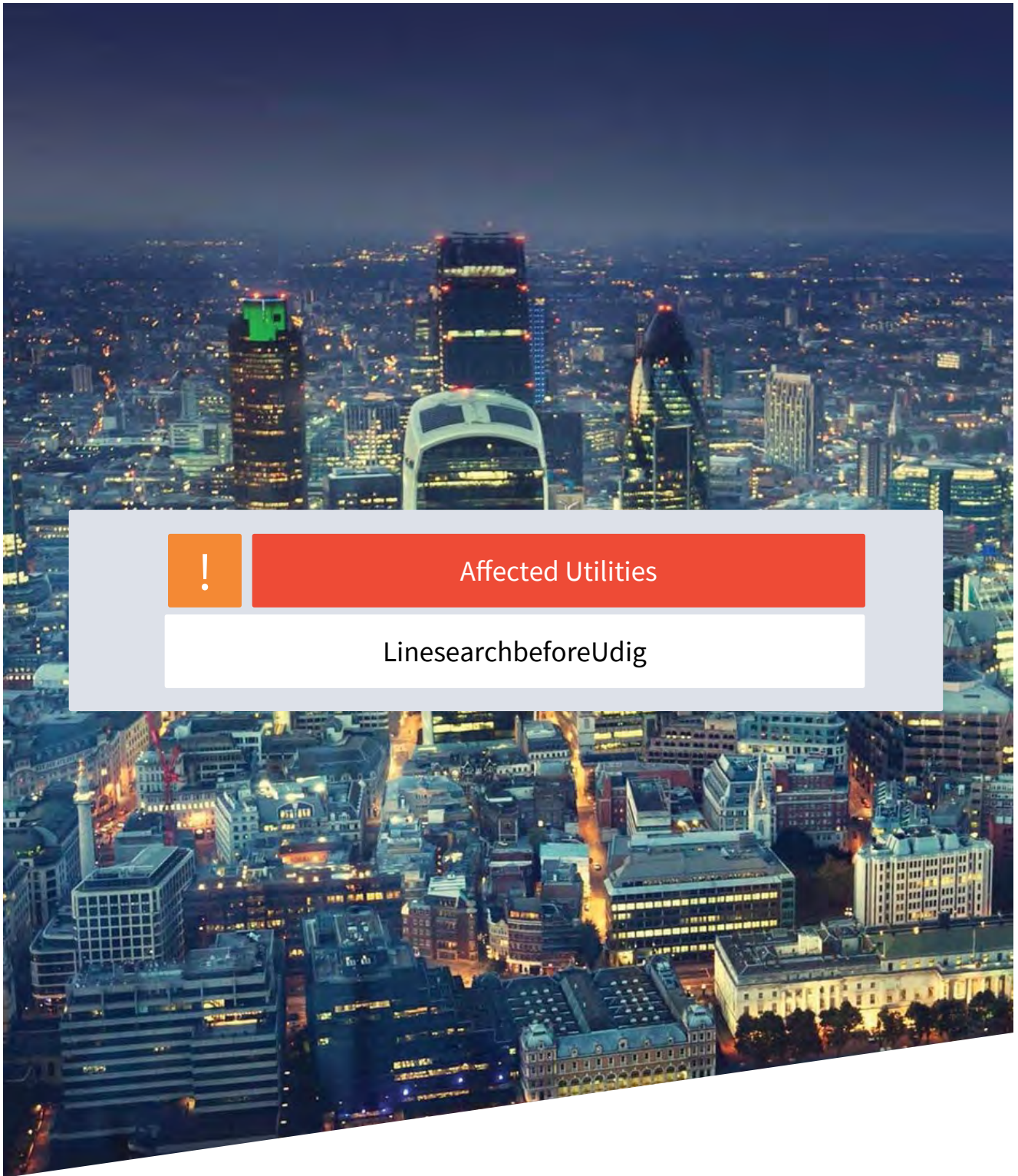

Affected Utilities

LineSearchbeforeUdig

Enquirer			
Name	Mr Ben Evans	Phone	01454662086
Company	Atkins - Utility Solutions	Mobile	Not Supplied
Address	The Hub, 500 Park Avenue, Aztec West Almondsbury Bristol BS32 4RZ		
Email	searches.utilitysolutions@atkinsglobal.com		

Enquiry Details			
Scheme/Reference	LM 115410/DK		
Enquiry type	Initial Enquiry	Work category	Utility Works
Start date	06/12/2022	Work type	Single excavations site (deeper than
End date	06/03/2023	Site size	242526 metres square
Searched location	XY= 265170, 201010	Work type buffer*	50 metres
Confirmed location	265236 200946		
Site Contact Name	Not Supplied	Site Phone No	Not Supplied
Description of Works			

\* The WORK TYPE BUFFER is a distance added to your search area based on the Work type you have chosen.



**LSBUD Members who have assets registered on the LSBUD service within the vicinity of your search area.**

### List of affected LSBUD members

Asset Owner	Phone/Email	Emergency Only	Status
National Grid Electricity Distribution	08000963080	08006783105	Await response
National Grid Electricity Transmission	08000014282	0800404090	Await response
National Grid Gas Transmission	01926654844	0800111999	Await response
Wales and West Utilities	02920278912	0800111999	Await response

**LSBUD Members who do not have assets registered on the LSBUD service within the vicinity of your search area. Please be aware that LSBUD Members make regular changes to their assets and this list may vary for new enquiries in the same area.**

### List of not affected LSBUD members

Angus Energy	AWE Pipeline	B & D Energy Limited
Balfour Beatty Investments Limited	BOC Limited (A Member of the Linde Group)	Box Broadband
BP Exploration Operating Company Limited	BPA	Cadent Gas
Carrington Gas Pipeline	CATS Pipeline c/o Wood Group PSN	Cemex
Centrica Storage Ltd	CNG Services Ltd	Concept Solutions People Ltd
ConocoPhillips (UK) Teesside Operator Ltd	D.S.Smith	Diamond Transmission Corporation
DIO (MOD Abandoned Pipelines)	DIO (MOD Live Pipelines)	E.ON UK CHP Limited
EDF Energy Renewables Ltd	EirGrid	Eleclink Limited
Electricity North West Limited	Energy Assets Networks	ENI & Himor c/o Penspen Ltd
EnQuest NNS Limited	EP Langage Limited	ESP Utilities Group
ESSAR	Esso Petroleum Company Limited	euNetworks Fiber UK Ltd
EXA Infrastructure	Exolum Pipeline System	Fulcrum Electricity Assets Limited
Fulcrum Pipelines Limited	Gamma	Gas Networks Ireland (UK)
Gateshead Energy Company	Gigaclear Ltd	Harbour Energy
Heathrow Airport LTD	Humbly Grove Energy	IGas Energy
INEOS FPS Pipelines	INEOS Manufacturing (Scotland and TSEP)	INOVYN ChlorVinyls Limited
INOVYN Enterprises Limited	Intergen (Coryton Energy or Spalding Energy)	Jurassic Fibre Ltd
Last Mile	Mainline Pipelines Limited	Manchester Jetline Limited
Manx Cable Company	Marchwood Power Ltd (Gas Pipeline)	Melbourn Solar Limited
Moray East Offshore Windfarm	MUA Group Limited	Neos Networks
Northumbrian Water Group	NPower CHP Pipelines	NTT Global Data Centers EMEA UK Ltd
NYnet Ltd	Ogi	Oikos Storage Limited
Ørsted	Palm Paper Ltd	Perenco UK Limited (Purbeck Southampton Pipeline)
Petroineos	Phillips 66	Portsmouth Water
Premier Transmission Ltd (SNIP)	Redundant Pipelines - LPDA	RWE - Great Yarmouth Pipeline (Bacton to Great Yarmouth Power Station)
RWEnpower (Little Barford and South Haven)	SABIC UK Petrochemicals	SAS Utility Services Ltd
Scottish and Southern Electricity Networks	Scottish Power Generation	Seabank Power Ltd

SES Water	SGN	Shell
Shell NOP	SP Energy Networks	Squire Energy Networks
SSE Generation Ltd	SSE Transmission	SSE Utility Solutions Limited
Tata Communications (c/o JSM Construction Ltd)	Total Colnbrook Pipelines	Total Finaline Pipelines
Transmission Capital	UK Power Networks	Uniper UK Ltd
University of Cambridge Granta Backbone Network	Vattenfall	Veolia ES SELCHP Limited
Veolia ES Sheffield Ltd	Voneus Limited	VPI Power Limited
West of Duddon Sands Transmission Ltd	Westminster City Council	Zayo Group UK Ltd c/o JSM Group Ltd



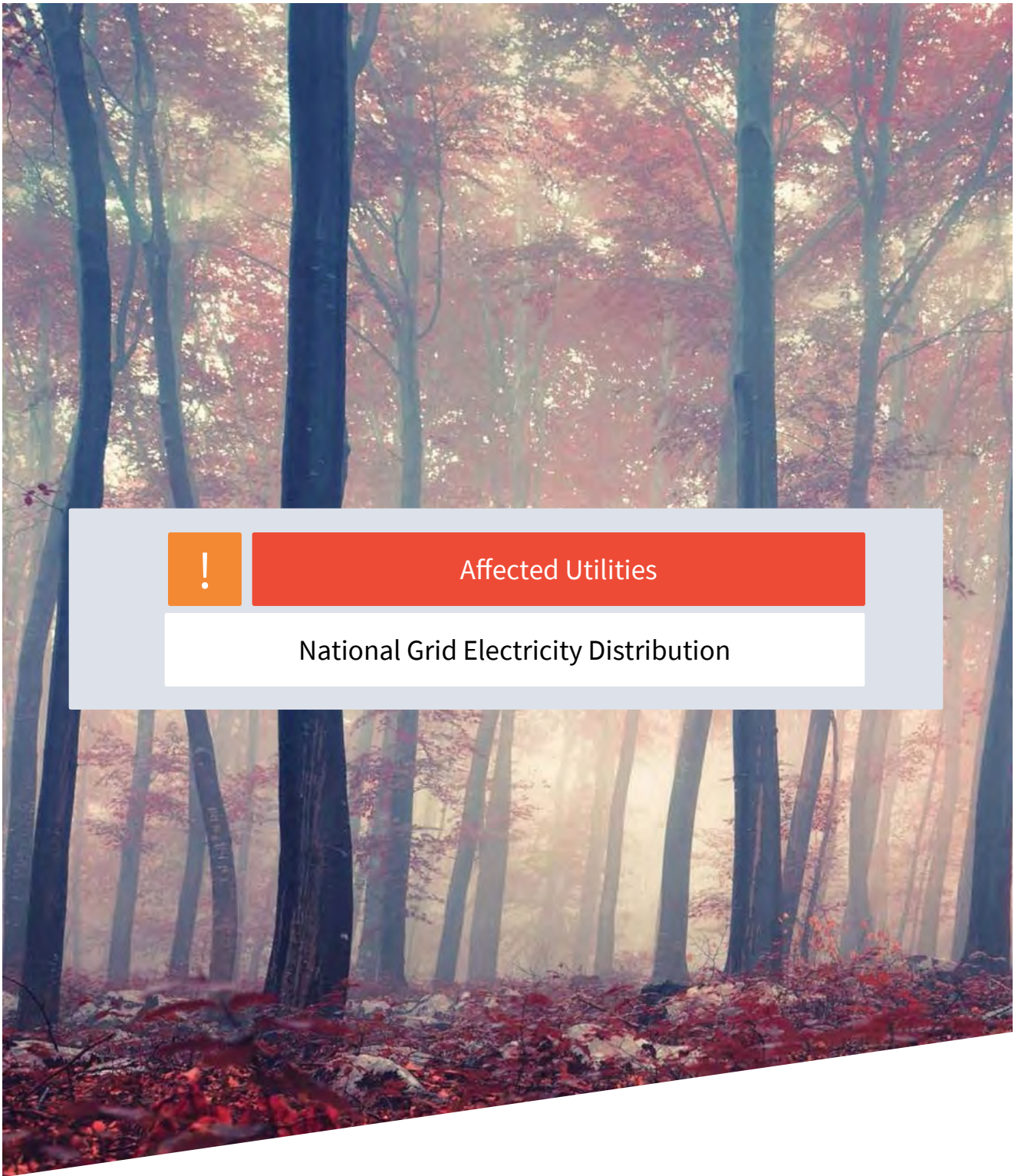

Affected Utilities

National Grid Electricity Distribution

Our Ref: 27820377      Your Ref: LM 115410/DK

Monday, 05 December 2022

Ben Evans  
The Hub, 500 Park Avenue, Aztec West  
Almondsbury  
Bristol  
BS32 4RZ



**National Grid Electricity  
Distribution**  
Mapping Centre  
Toll End Road  
Tipton  
West Midlands  
United Kingdom  
DY4 0HH  
www.nationalgrid.co.uk

Dear Ben Evans

Thank you for your enquiry dated Monday, 05 December 2022

I now enclose a copy of our plan showing existing National Grid Electricity Distribution (NGED) Electricity / National Grid Telecoms (NGT) apparatus in the vicinity of your proposed works. This information is given as a general guide only and its accuracy cannot be guaranteed. Please note that all NGED equipment on site should be assumed to be LIVE until NGED prove otherwise and provide you with confirmation to this effect in writing. Recent additions to our network, or service connections between the main cable and a building or street lamp may not be shown.

Map Response  
T 0121 623 9780  
NGED.MapResponse  
@nationalgrid.co.uk

Damage to underground cables and contact with overhead lines can cause severe injury or may prove fatal. If you are excavating on site in the vicinity of either NGED Electrical apparatus or NGT Telecoms apparatus you must comply with the requirements of the following:-

Health & Safety Executive guidance HS(G)47, Avoiding Danger from underground services.

Work taking place in the vicinity of our plant is also regulated under the:-

Electricity at Work Regulations 1989, Health and Safety Act 1974, CDM Regulations 2015.  
Safe working procedures should be defined and practiced

Please ensure that the use of mechanical excavators in the vicinity of our plant is kept to a minimum. NGT Telecoms ducts contain fibre cables, which are expensive to repair. Therefore, extreme care must be taken whilst working in the vicinity of these ducts, hand digging methods being used to determine their precise position.

If there are overhead lines crossing your site and your proposal involves building works which may infringe the clearance to our overhead system then you should call the relevant general enquiries number (see page 2 of this letter) for advice. Where overhead lines cross your site you must comply with the requirements of Health & Safety Executive guidance as laid down in GS6, Avoidance of Danger from Overhead Electric Lines.

National Grid Electricity  
Distribution  
South West - 02366894  
South Wales - 02366985  
East Midlands - 02366923  
West Midlands - 03600574

Where diversions to NGED apparatus are needed to allow change to occur on site, the cost of these alterations may be charged to the persons responsible for the works.

If you require advice in connection with your proposals please contact the relevant general enquiries number (see page 2 of this letter)

Registered in  
England and Wales

Following consultation the local NGED team will where necessary prepare detailed proposals and provide a quotation for any necessary alterations and/or development of our equipment on the site.

Registered Office:  
Avonbank  
Feeder Road  
Bristol  
BS2 0TB

This information is given as a guide only and its accuracy cannot be guaranteed. This plan is based on data from our Geographic Information System, which is updated every 24 hours to reflect changes to our network. The information contained in this plan reflects the most recent network GIS data, however changes to the network (including network additions and new service

### Safety Documents:

<https://www.nationalgrid.co.uk/customers-and-community/health-safety/public-safety-advice>

connections) may not be shown. You are advised to obtain an up to date plan on the date of commencing on-site works.

Yours sincerely  
NGED Map Response Team

#### **Contact Us**

##### **Emergency or Power Supply issues**

In an emergency call 105, 24 hours a day.

##### **Mapping Enquiries**

If you have an enquiry relating to this letter or the attached map plan, please contact us using the following information:

Telephone 0121 623 9780  
Email [NGED.MapResponse@nationalgrid.co.uk](mailto:NGED.MapResponse@nationalgrid.co.uk)

##### **General Enquiries**

If you have a general enquiry, please call us on the following telephone number:

All areas 0800 096 3080

##### **LSBUD**

If you have an enquiry relating to the use of the LSBUD website please contact LSBUD using the following information:

Telephone 0345 437 7365  
Email [enquiries@LSBUD.co.uk](mailto:enquiries@LSBUD.co.uk)  
Website [www.LSBUD.co.uk](http://www.LSBUD.co.uk)

## Steps to help keep you safe

- **If you are working within 10 metres of our 33kV, 66kV, 132kV underground electricity cables or within 10 meters of an overhead electricity line you should call the relevant General Enquiries for free safety advice.**

**Safety Documents** – please download our informative safety documents to help ensure that you, your staff and the public are kept safe whilst working in the vicinity of electricity.

<https://www.nationalgrid.co.uk/customers-and-community/health-safety/public-safety-advice>

- **Make sure you have up to date plans** - remember that recent additions to our network or service connections between the main cable and a building or street lamp may not be shown.
- **Look for signs of service cables** - an electricity meter box or nearby streetlamp may give you an indication that service cables are present in your area of work.
- **Non NGED Network** - electricity cables, lines and equipment owned by others may also be present in addition to NGED network. They are unlikely to be shown on our plans.
- **Use a cable locator** - trace electricity cables and mark the position of them using paint or other waterproof marking on the ground.
- **Hand dig trial holes** - to confirm the position of cables in close proximity to your area of your work and use spades and shovels rather than picks, pins or forks.
- **Have an emergency plan** - so that everyone working on site understands what to do in the event of an underground electricity cable being damaged or contact being made with an overhead electricity line.
- **If you are working within 10 meters** of an overhead electricity line then it may be necessary for you to erect warning signs and markers, or height restriction goal posts. Ensure that you comply with the requirements of Health & Safety Executive guidance laid down in GS6, Avoidance of Danger from Overhead Electric Lines.
- **If you are erecting a structure** that could allow anyone standing on it, or its access device (ladder, scaffold, MEWP), to come within 3m of any overhead electric line then **you must inform us**. This is your duty and a legal requirement under the Electricity Safety, Quality & Continuity Regulations 2002.
- **If you cannot work safely** around the underground electricity cable or overhead electricity line, then you may need to get it moved to allow your works to go ahead. Call the general enquiry numbers above for guidance.
- **It is possible that cables or pipes may be embedded in concrete** - electricity cables embedded in concrete **MUST** be made 'dead' by Western Power Distribution or the cable owner before the concrete is broken out. Alternatively, another safe way of working should be agreed.
- **Cables are sometimes covered by tiles or a marker tape** - these can be concrete, polythene or earthenware and are a useful early warning of the presence of cables; you should avoid disturbing any tiles or tape to expose the cable. Not all cables have these warning indicators.

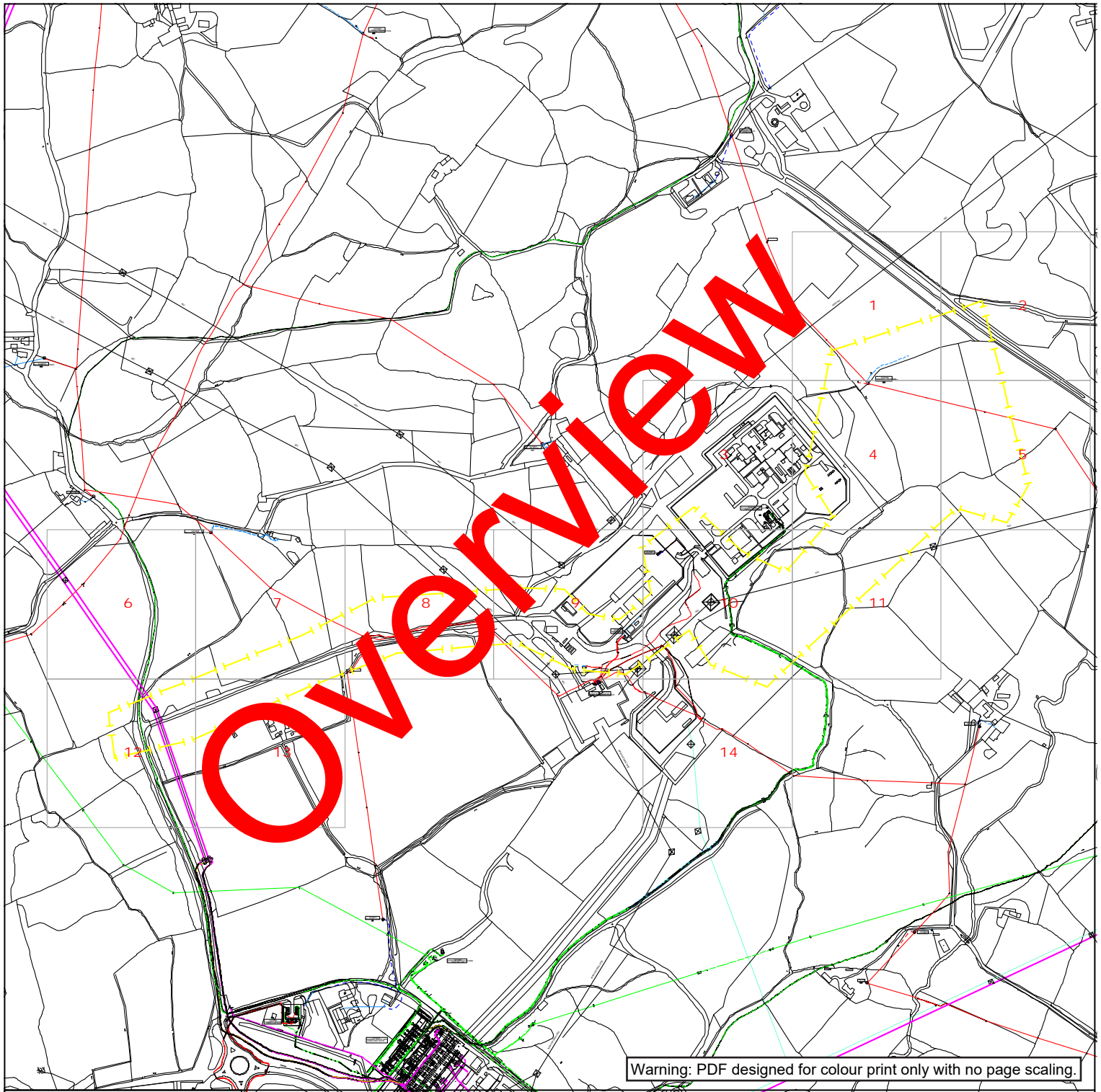

Warning: PDF designed for colour print only with no page scaling.

**nationalgrid** Electricity Distribution

**Contact Us**

**Mapping Enquiries:**  
All areas 0121 623 9780

**General Enquiries:**  
All areas 0800 096 3080

Date Requested: 05/12/2022  
Job Reference: 27820377  
Site Location: 264753 200956  
Requested by:  
Mr Ben Evans  
Your Scheme/Reference:  
LM 115410/DK

Link Box	Overhead Line	Underground Cable	National Grid Telecoms	Pilot Cables
●	○ PL ○ Service ○ LV ○ HV (11kV) ○ HV (33kV) ○ HV (66kV) ○ HV (132kV)	---	--- PME Earth ---E Underground Earth	--- Pole Mounted Transformer □ Ground Mounted Transformer

**IMPORTANT NOTICES**

- This information is given as a guide only and its accuracy cannot be guaranteed. Services or recent additions to the network may not be shown.
- Cables, overhead lines & substations owned by other electricity network owners or private companies may be present and may not be shown.
- You should always verify exact locations of cables using a cable locator and by careful use of hand tools in accordance with HSE guidance note HSG47.
- When working within 10m of any overhead electric line you should follow the requirements of HSE Guidance Note GS6.
- For further advice on working near our electricity cables or lines, call our General Enquiries number.
- Advice should be sought from the National Grid Electricity Distribution General Enquiries team for any work that is to take place in proximity to 132kV underground cables and 132kV overhead lines.

**Report damage immediately – KEEP EVERYONE AWAY FROM THE AREA**  
**0800 6783 105**

Crown Copyright © All Rights Reserved. Ordnance Survey Licence numbers: 100022432  
NGED Copyright: This copy has been made by or with the authority of National Grid Electricity Distribution (NGED) pursuant to Section 47 of the Copyright Designs and Patents Act 1988 unless that Act provides a relevant exception to copyright the copy must not be copied without the prior permission of the copyright owner.

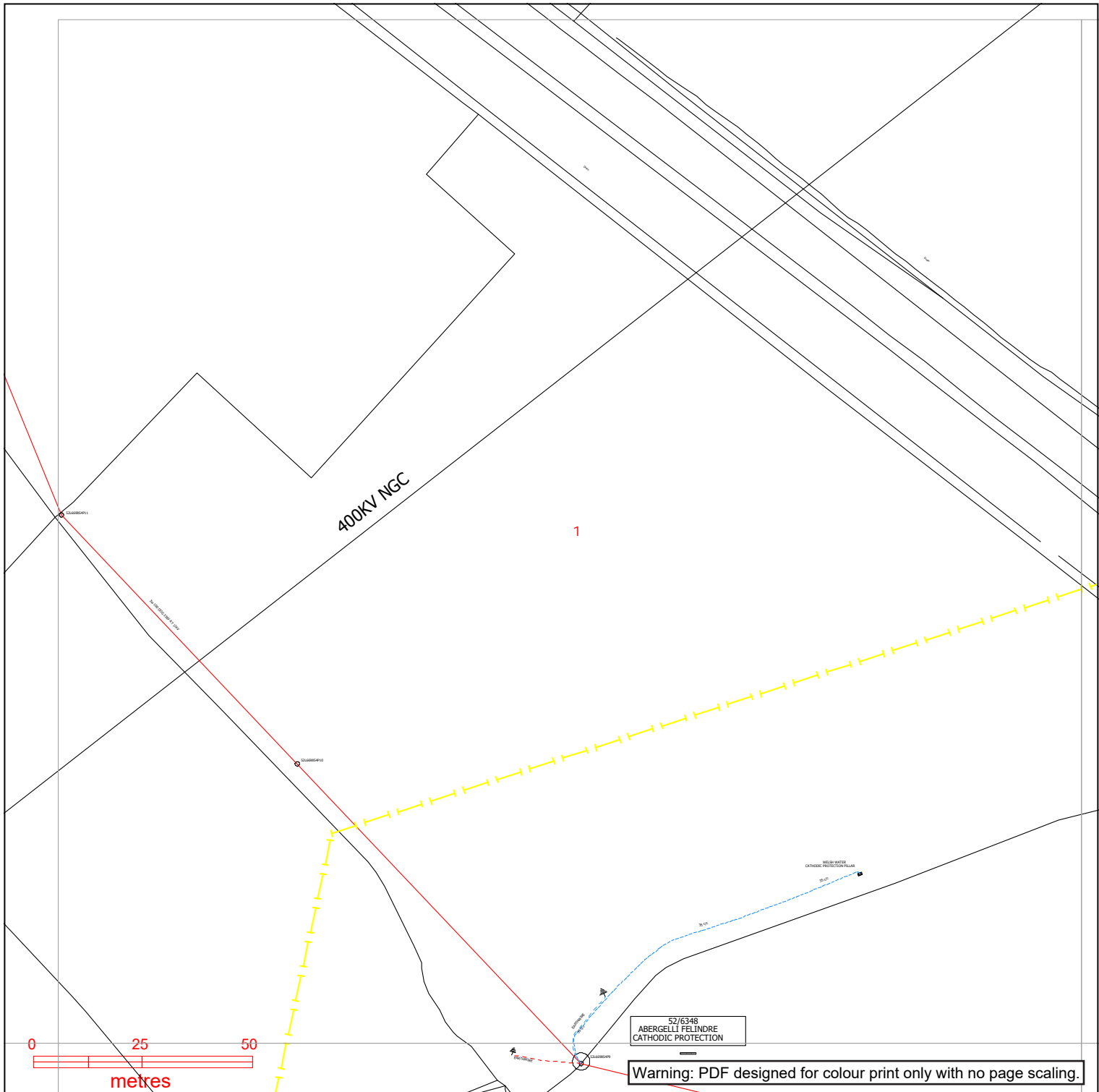

**nationalgrid** Electricity Distribution

**Contact Us**

**Mapping Enquiries:**  
All areas 0121 623 9780

**General Enquiries:**  
All areas 0800 096 3080

Date Requested: 05/12/2022  
Job Reference: 27820377  
Site Location: 264753 200956  
Requested by:  
Mr Ben Evans  
Your Scheme/Reference:  
LM 115410/DK

Exact Scales:  
1:1250 Area or Circle dig site  
1:500 Line dig site

Link Box	Overhead Line	Underground Cable	National Grid Telecoms	Pilot Cables
●	○ PL ○ Service ○ LV ○ HV (11kV) ○ HV (33kV) ○ HV (66kV) ○ HV (132kV)	---	--- PME Earth --- Underground Earth	○ Pole Mounted Transformer □ Ground Mounted Transformer

**IMPORTANT NOTICES**

- This information is given as a guide only and its accuracy cannot be guaranteed. Services or recent additions to the network may not be shown.
- Cables, overhead lines & substations owned by other electricity network owners or private companies may be present and may not be shown.
- You should always verify exact locations of cables using a cable locator and by careful use of hand tools in accordance with HSE guidance note HSG47.
- When working within 10m of any overhead electric line you should follow the requirements of HSE Guidance Note GS6.
- For further advice on working near our electricity cables or lines, call our General Enquiries number.
- Advice should be sought from the National Grid Electricity Distribution General Enquiries team for any work that is to take place in proximity to 132kV underground cables and 132kV overhead lines.

**Report damage immediately – KEEP EVERYONE AWAY FROM THE AREA**  
**0800 6783 105**

Crown Copyright © All Rights Reserved. Ordnance Survey Licence numbers: 100022432  
NGED Copyright: This copy has been made by or with the authority of National Grid Electricity Distribution (NGED) pursuant to Section 47 of the Copyright Designs and Patents Act 1988 unless that Act provides a relevant exception to copyright the copy must not be copied without the prior permission of the copyright owner.

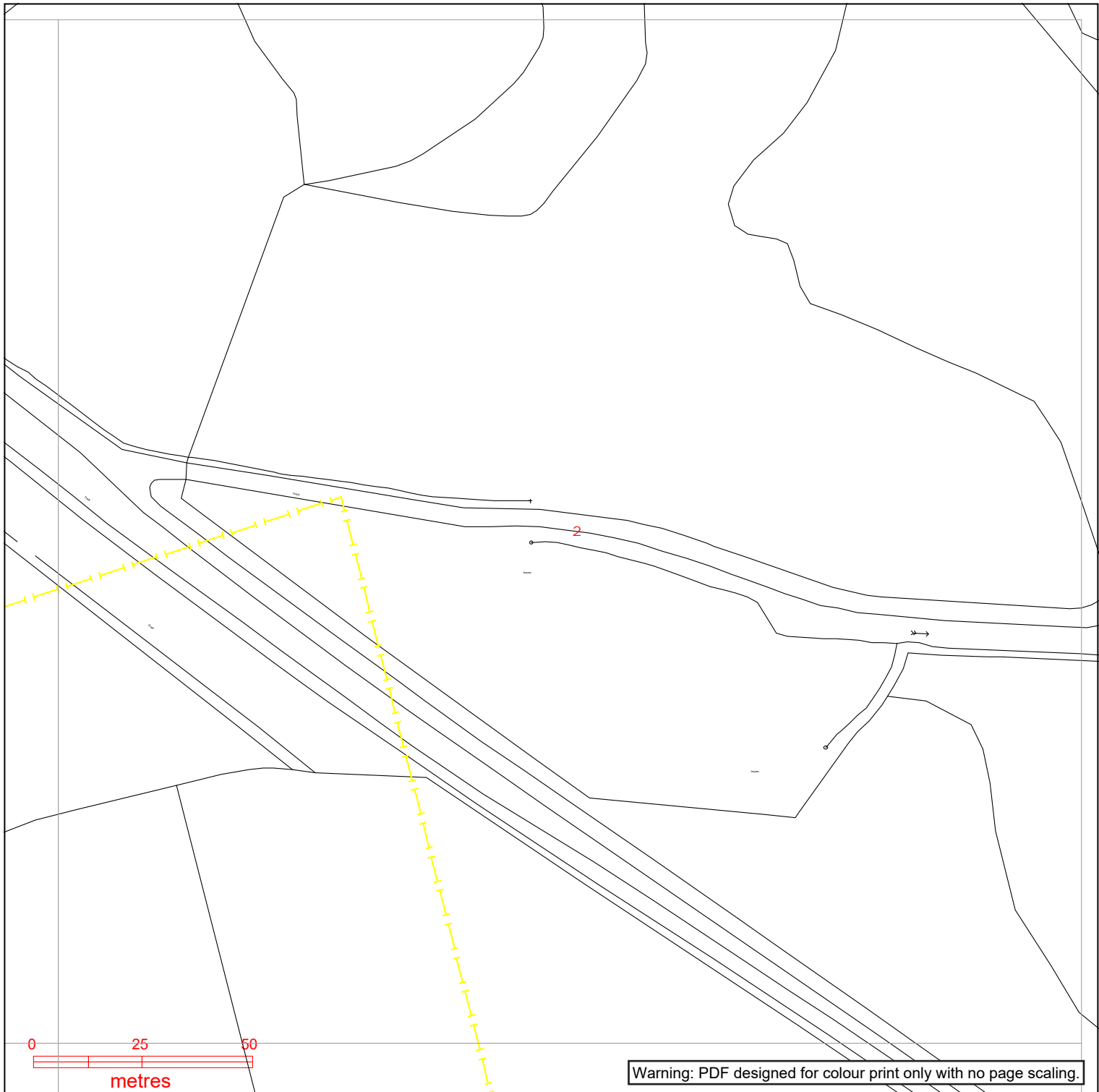

Warning: PDF designed for colour print only with no page scaling.

**nationalgrid** Electricity Distribution

**Contact Us**

**Mapping Enquiries:**  
All areas 0121 623 9780

**General Enquiries:**  
All areas 0800 096 3080

Date Requested: 05/12/2022  
Job Reference: 27820377  
Site Location: 264753 200956  
Requested by:  
Mr Ben Evans  
Your Scheme/Reference:  
LM 115410/DK

Exact Scales:  
1:1250 Area or Circle dig site  
1:500 Line dig site

<b>Link Box</b> ●	<b>Overhead Line</b> ○ ○ PL ○ ○ Service ○ ○ LV ○ ○ HV (11kV) ○ ○ HV (33kV) ○ ○ HV (66kV) ○ ○ HV (132kV)	<b>Underground Cable</b> -	<b>National Grid Telecoms</b> - - - - - PME Earth -E- - - - - Underground Earth	<b>Pilot Cables</b> ○ Pole Mounted Transformer □ Ground Mounted Transformer
----------------------	--	---	---	---

**IMPORTANT NOTICES**

- This information is given as a guide only and its accuracy cannot be guaranteed. Services or recent additions to the network may not be shown.
- Cables, overhead lines & substations owned by other electricity network owners or private companies may be present and may not be shown.
- You should always verify exact locations of cables using a cable locator and by careful use of hand tools in accordance with HSE guidance note HSG47.
- When working within 10m of any overhead electric line you should follow the requirements of HSE Guidance Note GS6.
- For further advice on working near our electricity cables or lines, call our General Enquiries number.
- Advice should be sought from the National Grid Electricity Distribution General Enquiries team for any work that is to take place in proximity to 132kV underground cables and 132kV overhead lines.

**Report damage immediately – KEEP EVERYONE AWAY FROM THE AREA**  
**0800 6783 105**

Crown Copyright © All Rights Reserved. Ordnance Survey Licence numbers: 100022432  
NGED Copyright: This copy has been made by or with the authority of National Grid Electricity Distribution (NGED) pursuant to Section 47 of the Copyright Designs and Patents Act 1988 unless that Act provides a relevant exception to copyright the copy must not be copied without the prior permission of the copyright owner.



**nationalgrid** Electricity Distribution

**Contact Us**

**Mapping Enquiries:**  
All areas 0121 623 9780

**General Enquiries:**  
All areas 0800 096 3080

Date Requested: 05/12/2022  
Job Reference: 27820377  
Site Location: 264753 200956  
Requested by:  
Mr Ben Evans  
Your Scheme/Reference:  
LM 115410/DK

Exact Scales:  
1:1250 Area or Circle dig site  
1:500 Line dig site

Link Box	Overhead Line	Underground Cable	National Grid Telecoms	Pilot Cables
●	○ PL ○ Service ○ LV ○ HV (11kV) ○ HV (33kV) ○ HV (66kV) ○ HV (132kV)	--- --- --- ---	--- --- --- ---	○ Pole Mounted Transformer □ Ground Mounted Transformer
■ Site Location Line/Area	■	■	■ PME Earth ■ Underground Earth	

**IMPORTANT NOTICES**

- This information is given as a guide only and its accuracy cannot be guaranteed. Services or recent additions to the network may not be shown.
- Cables, overhead lines & substations owned by other electricity network owners or private companies may be present and may not be shown.
- You should always verify exact locations of cables using a cable locator and by careful use of hand tools in accordance with HSE guidance note HSG47.
- When working within 10m of any overhead electric line you should follow the requirements of HSE Guidance Note GS6.
- For further advice on working near our electricity cables or lines, call our General Enquiries number.
- Advice should be sought from the National Grid Electricity Distribution General Enquiries team for any work that is to take place in proximity to 132kV underground cables and 132kV overhead lines.

**Report damage immediately – KEEP EVERYONE AWAY FROM THE AREA**  
**0800 6783 105**

Crown Copyright © All Rights Reserved. Ordnance Survey Licence numbers: 100022432  
NGED Copyright: This copy has been made by or with the authority of National Grid Electricity Distribution (NGED) pursuant to Section 47 of the Copyright Designs and Patents Act 1988 unless that Act provides a relevant exception to copyright the copy must not be copied without the prior permission of the copyright owner.



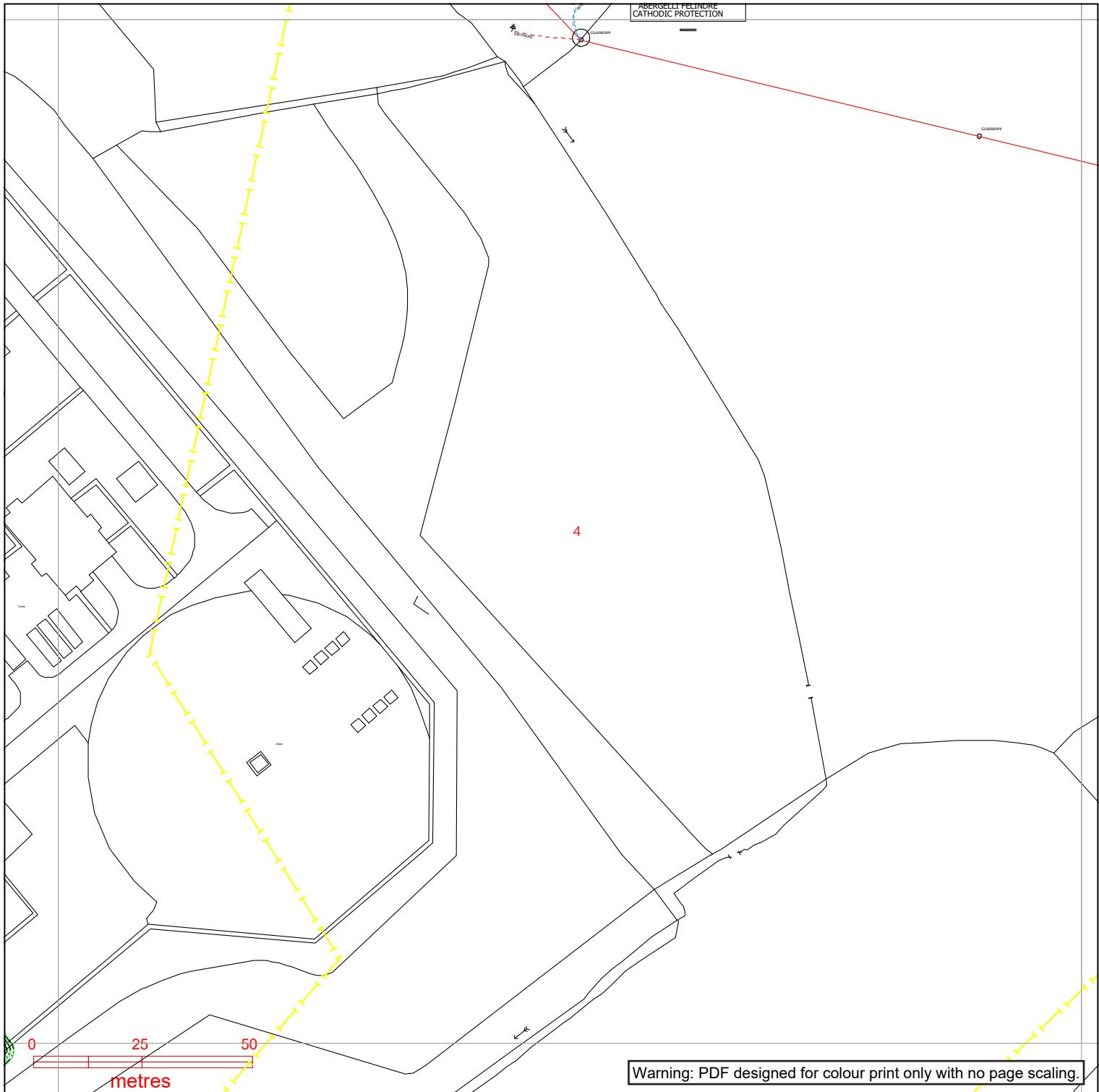

**nationalgrid** Electricity Distribution

**Contact Us**

**Mapping Enquiries:**  
All areas 0121 623 9780

**General Enquiries:**  
All areas 0800 096 3080

Date Requested: 05/12/2022  
Job Reference: 27820377  
Site Location: 264753 200956  
Requested by:  
Mr Ben Evans  
Your Scheme/Reference:  
LM 115410/DK

Exact Scales:  
1:1250 Area or Circle dig site  
1:500 Line dig site

Link Box	Overhead Line	Underground Cable	National Grid Telecoms	Pilot Cables
●	<ul style="list-style-type: none"> <li>○ PL</li> <li>○ Service</li> <li>○ LV</li> <li>○ HV (11kV)</li> <li>○ HV (33kV)</li> <li>○ HV (66kV)</li> <li>○ HV (132kV)</li> </ul>	<ul style="list-style-type: none"> <li>---</li> <li>---</li> <li>---</li> <li>---</li> <li>---</li> <li>---</li> <li>---</li> </ul>	<ul style="list-style-type: none"> <li>--- PME Earth</li> <li>---E Underground Earth</li> </ul>	<ul style="list-style-type: none"> <li>○ Pole Mounted Transformer</li> <li>□ Ground Mounted Transformer</li> </ul>
<ul style="list-style-type: none"> <li>--- Site Location</li> <li>--- Line/Area</li> </ul>				

**IMPORTANT NOTICES**

- This information is given as a guide only and its accuracy cannot be guaranteed. Services or recent additions to the network may not be shown.
- Cables, overhead lines & substations owned by other electricity network owners or private companies may be present and may not be shown.
- You should always verify exact locations of cables using a cable locator and by careful use of hand tools in accordance with HSE guidance note HSG47.
- When working within 10m of any overhead electric line you should follow the requirements of HSE Guidance Note GS6.
- For further advice on working near our electricity cables or lines, call our General Enquiries number.
- Advice should be sought from the National Grid Electricity Distribution General Enquiries team for any work that is to take place in proximity to 132kV underground cables and 132kV overhead lines.

**Report damage immediately – KEEP EVERYONE AWAY FROM THE AREA**  
**0800 6783 105**

Crown Copyright © All Rights Reserved. Ordnance Survey Licence numbers: 100022432  
NGED Copyright: This copy has been made by or with the authority of National Grid Electricity Distribution (NGED) pursuant to Section 47 of the Copyright Designs and Patents Act 1988 unless that Act provides a relevant exception to copyright the copy must not be copied without the prior permission of the copyright owner.

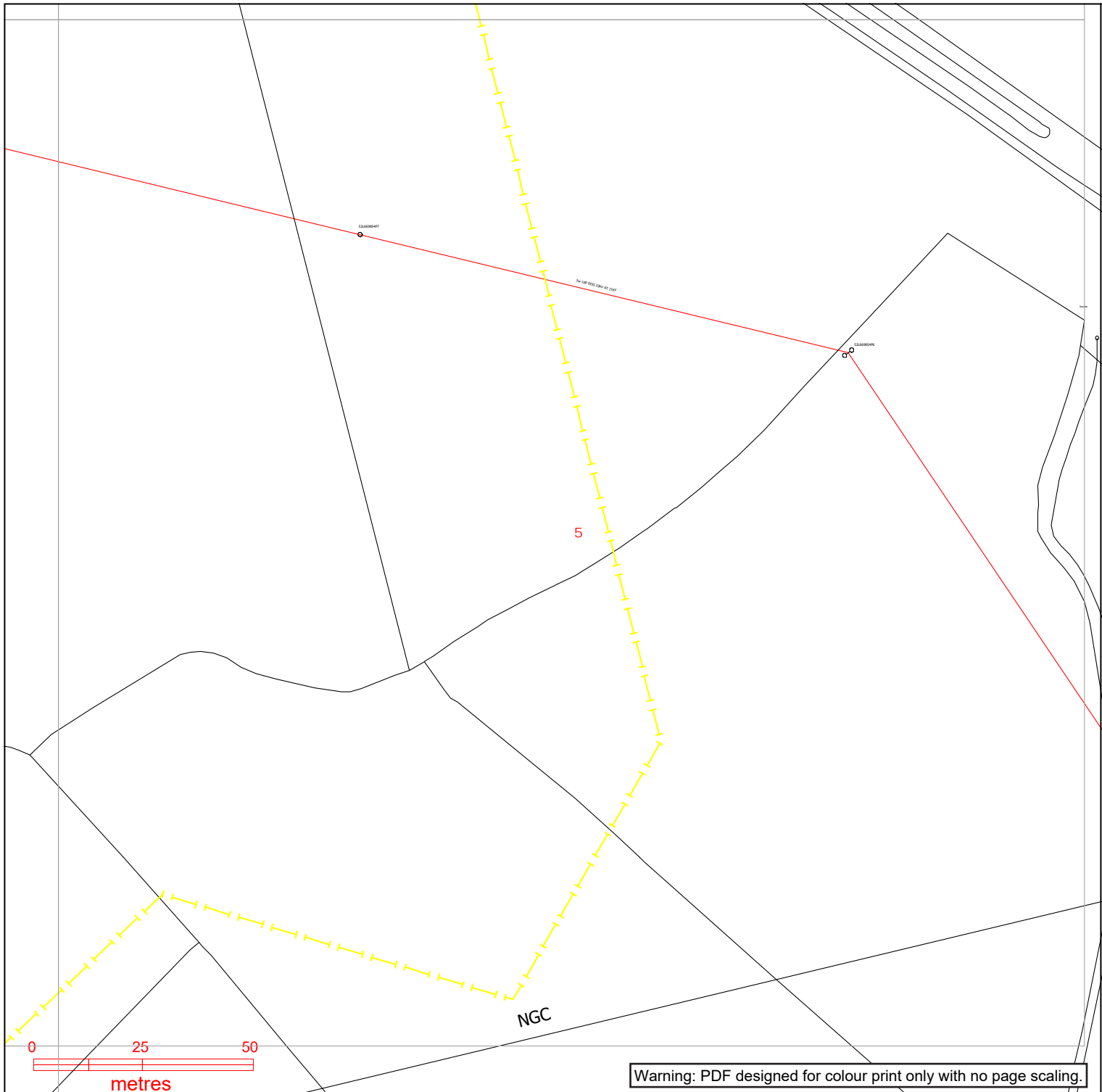

Warning: PDF designed for colour print only with no page scaling.

**nationalgrid** Electricity Distribution

**Contact Us**

**Mapping Enquiries:**  
All areas 0121 623 9780

**General Enquiries:**  
All areas 0800 096 3080

Date Requested: 05/12/2022  
Job Reference: 27820377  
Site Location: 264753 200956  
Requested by:  
Mr Ben Evans  
Your Scheme/Reference:  
LM 115410/DK

Exact Scales:  
1:1250 Area or Circle dig site  
1:500 Line dig site

Link Box	Overhead Line	Underground Cable	National Grid Telecoms	Pilot Cables
●	<ul style="list-style-type: none"> <li>○ PL</li> <li>○ Service</li> <li>○ LV</li> <li>○ HV (11kV)</li> <li>○ HV (33kV)</li> <li>○ HV (66kV)</li> <li>○ HV (132kV)</li> </ul>	<ul style="list-style-type: none"> <li>---</li> <li>---</li> <li>---</li> <li>---</li> <li>---</li> <li>---</li> <li>---</li> </ul>	<ul style="list-style-type: none"> <li>--- PME Earth</li> <li>---E Underground Earth</li> </ul>	<ul style="list-style-type: none"> <li>○ Pole Mounted Transformer</li> <li>□ Ground Mounted Transformer</li> </ul>
Site Location Line/Area	<ul style="list-style-type: none"> <li>--- (Yellow dashed line)</li> </ul>			

**IMPORTANT NOTICES**

- This information is given as a guide only and its accuracy cannot be guaranteed. Services or recent additions to the network may not be shown.
- Cables, overhead lines & substations owned by other electricity network owners or private companies may be present and may not be shown.
- You should always verify exact locations of cables using a cable locator and by careful use of hand tools in accordance with HSE guidance note HSG47.
- When working within 10m of any overhead electric line you should follow the requirements of HSE Guidance Note GS6.
- For further advice on working near our electricity cables or lines, call our General Enquiries number.
- Advice should be sought from the National Grid Electricity Distribution General Enquiries team for any work that is to take place in proximity to 132kV underground cables and 132kV overhead lines.

**Report damage immediately – KEEP EVERYONE AWAY FROM THE AREA**  
**0800 6783 105**

Crown Copyright © All Rights Reserved. Ordnance Survey Licence numbers: 100022432  
NGED Copyright: This copy has been made by or with the authority of National Grid Electricity Distribution (NGED) pursuant to Section 47 of the Copyright Designs and Patents Act 1988 unless that Act provides a relevant exception to copyright the copy must not be copied without the prior permission of the copyright owner.

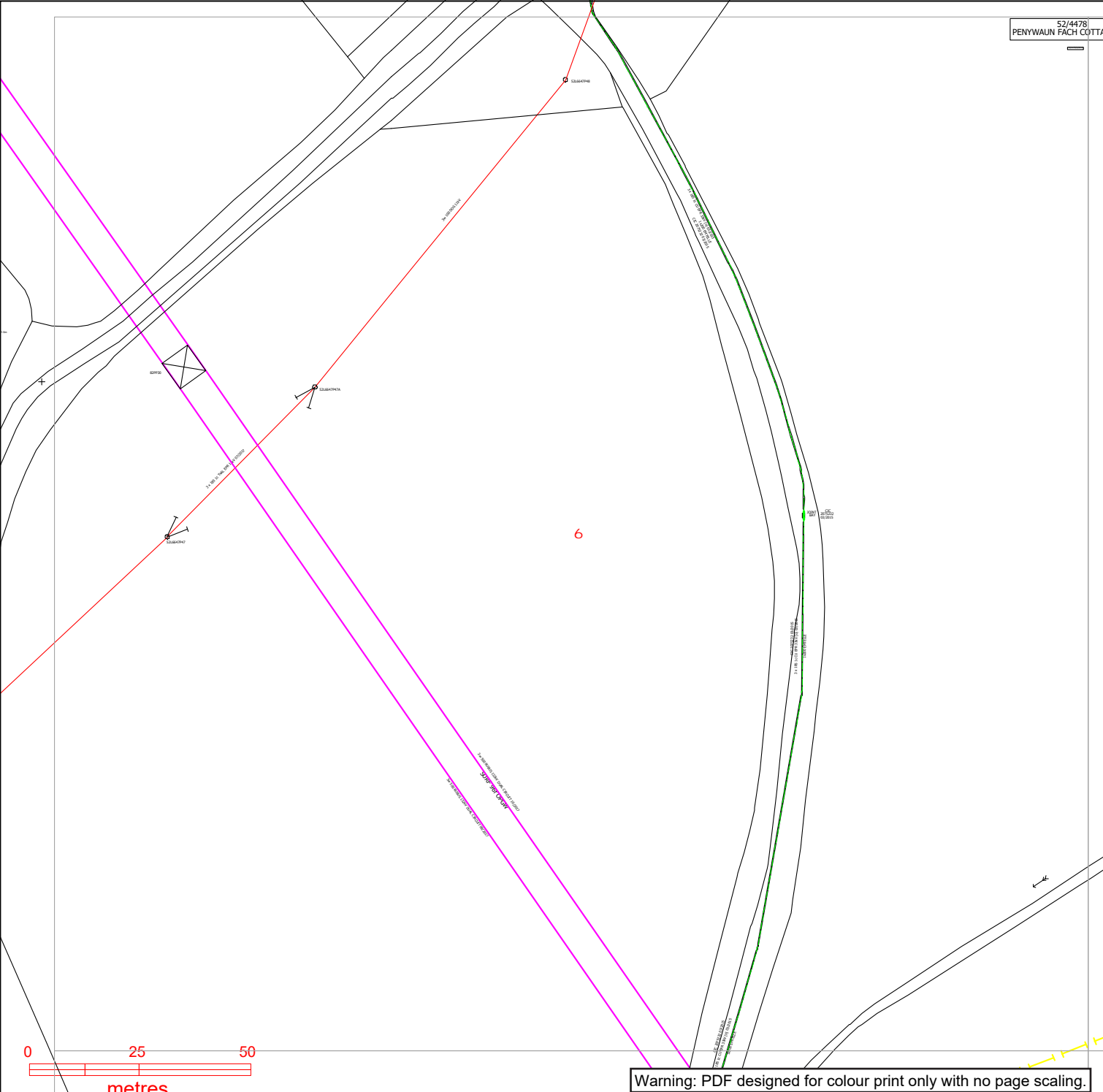

**Contact Us**

**Mapping Enquiries:**  
All areas 0121 623 9780

**General Enquiries:**  
All areas 0800 096 3080

Date Requested: 05/12/2022  
Job Reference: 27820377  
Site Location: 264753 200956  
Requested by:  
Mr Ben Evans  
Your Scheme/Reference:  
LM 115410/DK

Exact Scales:  
1:1250 Area or Circle dig site  
1:500 Line dig site

Link Box	Overhead Line	Underground Cable	National Grid Telecoms	Pilot Cables

**IMPORTANT NOTICES**

- This information is given as a guide only and its accuracy cannot be guaranteed. Services or recent additions to the network may not be shown.
- Cables, overhead lines & substations owned by other electricity network owners or private companies may be present and may not be shown.
- You should always verify exact locations of cables using a cable locator and by careful use of hand tools in accordance with HSE guidance note HSG47.
- When working within 10m of any overhead electric line you should follow the requirements of HSE Guidance Note GS6.
- For further advice on working near our electricity cables or lines, call our General Enquiries number.
- Advice should be sought from the National Grid Electricity Distribution General Enquiries team for any work that is to take place in proximity to 132kV underground cables and 132kV overhead lines.

**Report damage immediately – KEEP EVERYONE AWAY FROM THE AREA**  
**0800 6783 105**

Crown Copyright © All Rights Reserved. Ordnance Survey Licence numbers: 100022432  
NGED Copyright: This copy has been made by or with the authority of National Grid Electricity Distribution (NGED) pursuant to Section 47 of the Copyright Designs and Patents Act 1988 unless that Act provides a relevant exception to copyright the copy must not be copied without the prior permission of the copyright owner.

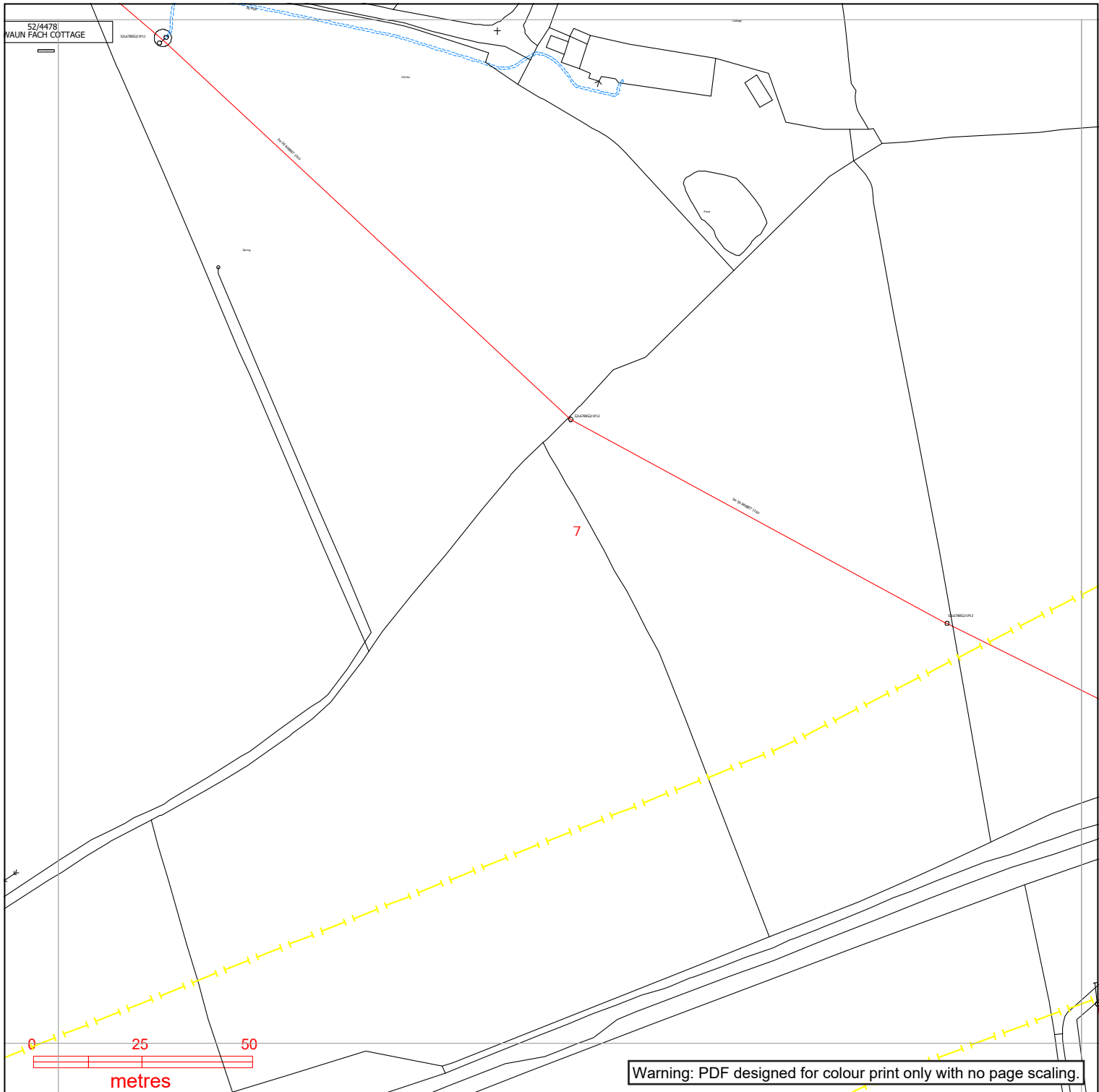

Warning: PDF designed for colour print only with no page scaling.

**nationalgrid** Electricity Distribution

**Contact Us**

**Mapping Enquiries:**  
All areas 0121 623 9780

**General Enquiries:**  
All areas 0800 096 3080

Date Requested: 05/12/2022  
Job Reference: 27820377  
Site Location: 264753 200956  
Requested by:  
Mr Ben Evans  
Your Scheme/Reference:  
LM 115410/DK

Exact Scales:  
1:1250 Area or Circle dig site  
1:500 Line dig site

Link Box	Overhead Line	Underground Cable	National Grid Telecoms	Pilot Cables
●	<ul style="list-style-type: none"> <li>○ PL</li> <li>○ Service</li> <li>○ LV</li> <li>○ HV (11kV)</li> <li>○ HV (33kV)</li> <li>○ HV (66kV)</li> <li>○ HV (132kV)</li> </ul>	<ul style="list-style-type: none"> <li>---</li> <li>---</li> <li>---</li> <li>---</li> <li>---</li> <li>---</li> </ul>	<ul style="list-style-type: none"> <li>--- PME Earth</li> <li>---E Underground Earth</li> </ul>	<ul style="list-style-type: none"> <li>○ Pole Mounted Transformer</li> <li>□ Ground Mounted Transformer</li> </ul>
Site Location Line/Area	<ul style="list-style-type: none"> <li>--- Site Location</li> <li>--- Line/Area</li> </ul>			

**IMPORTANT NOTICES**

- This information is given as a guide only and its accuracy cannot be guaranteed. Services or recent additions to the network may not be shown.
- Cables, overhead lines & substations owned by other electricity network owners or private companies may be present and may not be shown.
- You should always verify exact locations of cables using a cable locator and by careful use of hand tools in accordance with HSE guidance note HSG47.
- When working within 10m of any overhead electric line you should follow the requirements of HSE Guidance Note GS6.
- For further advice on working near our electricity cables or lines, call our General Enquiries number.
- Advice should be sought from the National Grid Electricity Distribution General Enquiries team for any work that is to take place in proximity to 132kV underground cables and 132kV overhead lines.

**Report damage immediately – KEEP EVERYONE AWAY FROM THE AREA**  
**0800 6783 105**

Crown Copyright © All Rights Reserved. Ordnance Survey Licence numbers: 100022432  
NGED Copyright: This copy has been made by or with the authority of National Grid Electricity Distribution (NGED) pursuant to Section 47 of the Copyright Designs and Patents Act 1988 unless that Act provides a relevant exception to copyright the copy must not be copied without the prior permission of the copyright owner.

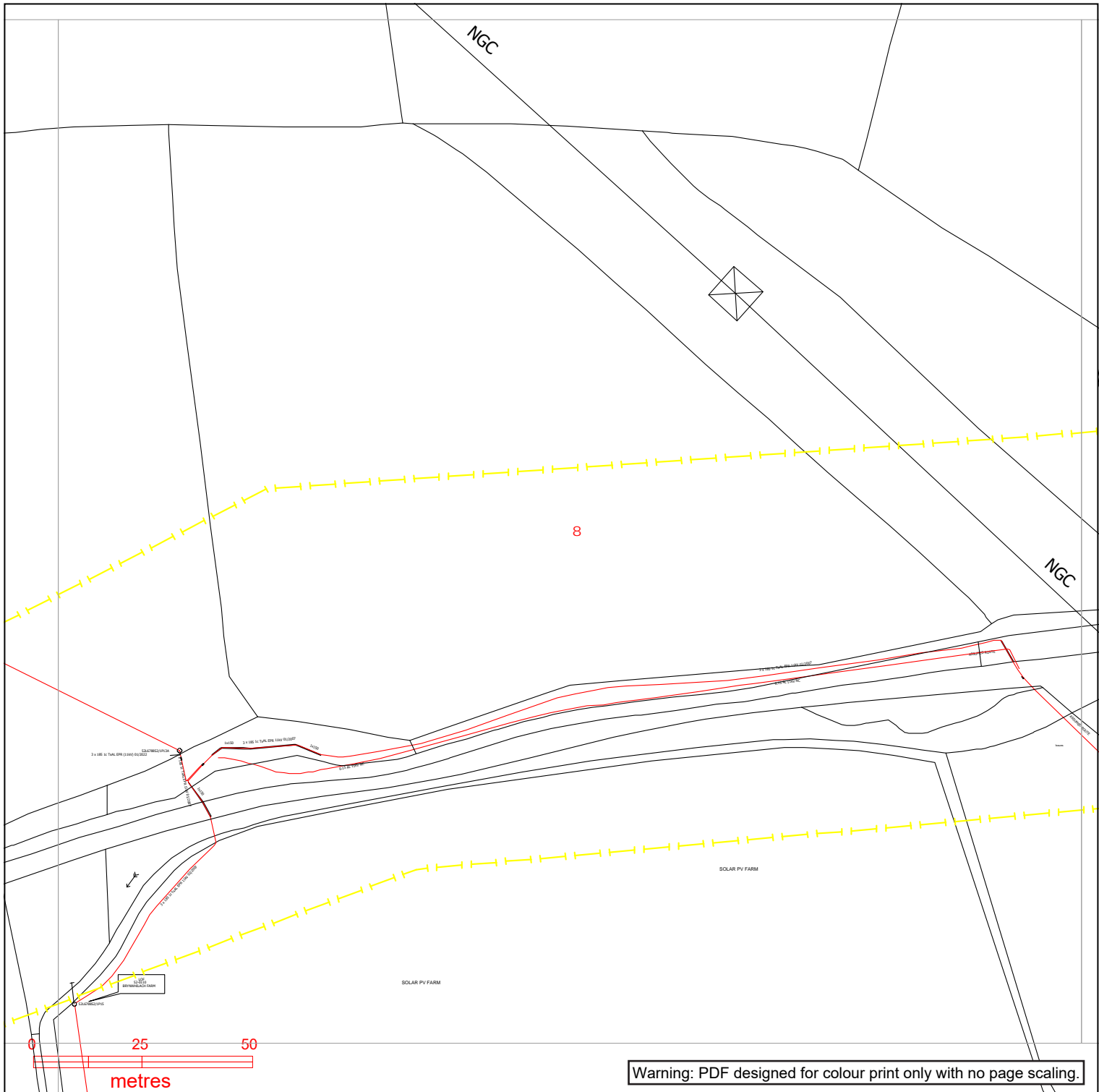

Warning: PDF designed for colour print only with no page scaling.

**nationalgrid** Electricity Distribution

**Contact Us**

**Mapping Enquiries:**  
All areas 0121 623 9780

**General Enquiries:**  
All areas 0800 096 3080

Date Requested: 05/12/2022  
Job Reference: 27820377  
Site Location: 264753 200956  
Requested by:  
Mr Ben Evans  
Your Scheme/Reference:  
LM 115410/DK

Exact Scales:  
1:1250 Area or Circle dig site  
1:500 Line dig site

Link Box	Overhead Line	Underground Cable	National Grid Telecoms	Pilot Cables
●	<ul style="list-style-type: none"> <li>○ PL</li> <li>○ Service</li> <li>○ LV</li> <li>○ HV (11kV)</li> <li>○ HV (33kV)</li> <li>○ HV (66kV)</li> <li>○ HV (132kV)</li> </ul>	<ul style="list-style-type: none"> <li>---</li> <li>---</li> <li>---</li> <li>---</li> <li>---</li> <li>---</li> <li>---</li> </ul>	<ul style="list-style-type: none"> <li>--- PME Earth</li> <li>--- Underground Earth</li> </ul>	<ul style="list-style-type: none"> <li>○ Pole Mounted Transformer</li> <li>□ Ground Mounted Transformer</li> </ul>
Site Location Line/Area	<ul style="list-style-type: none"> <li>--- (Yellow dashed line)</li> </ul>			

**IMPORTANT NOTICES**

- This information is given as a guide only and its accuracy cannot be guaranteed. Services or recent additions to the network may not be shown.
- Cables, overhead lines & substations owned by other electricity network owners or private companies may be present and may not be shown.
- You should always verify exact locations of cables using a cable locator and by careful use of hand tools in accordance with HSE guidance note HSG47.
- When working within 10m of any overhead electric line you should follow the requirements of HSE Guidance Note GS6.
- For further advice on working near our electricity cables or lines, call our General Enquiries number.
- Advice should be sought from the National Grid Electricity Distribution General Enquiries team for any work that is to take place in proximity to 132kV underground cables and 132kV overhead lines.

**Report damage immediately – KEEP EVERYONE AWAY FROM THE AREA**  
**0800 6783 105**

Crown Copyright © All Rights Reserved. Ordnance Survey Licence numbers: 100022432  
NGED Copyright: This copy has been made by or with the authority of National Grid Electricity Distribution (NGED) pursuant to Section 47 of the Copyright Designs and Patents Act 1988 unless that Act provides a relevant exception to copyright the copy must not be copied without the prior permission of the copyright owner.



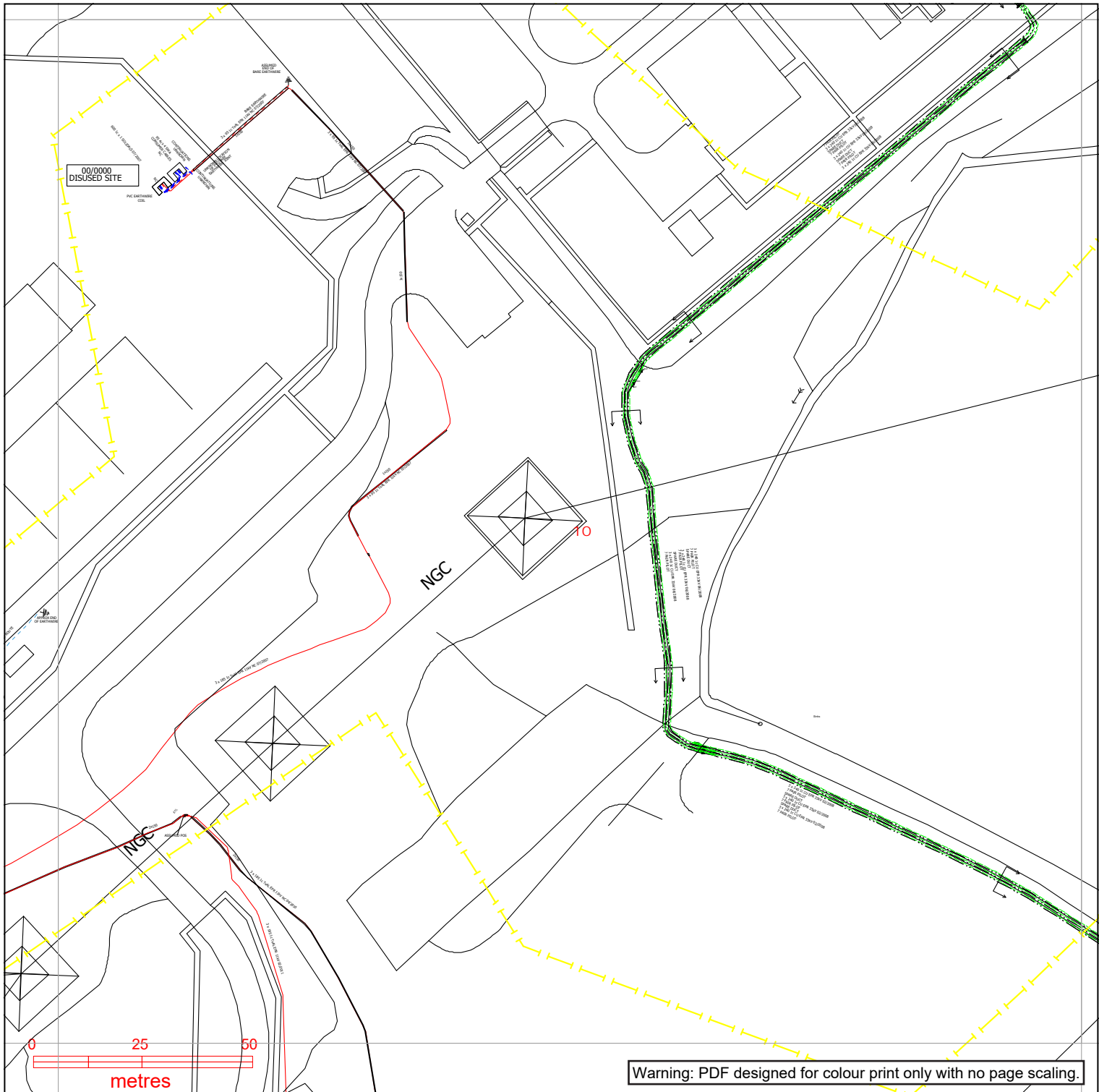

**nationalgrid** Electricity Distribution

**Contact Us**

**Mapping Enquiries:**  
All areas 0121 623 9780

**General Enquiries:**  
All areas 0800 096 3080

Date Requested: 05/12/2022  
Job Reference: 27820377  
Site Location: 264753 200956  
Requested by:  
Mr Ben Evans  
Your Scheme/Reference:  
LM 115410/DK

Exact Scales:  
1:1250 Area or Circle dig site  
1:500 Line dig site

Link Box	Overhead Line	Underground Cable	National Grid Telecoms	Pilot Cables
●	○ PL ○ Service ○ LV ○ HV (11kV) ○ HV (33kV) ○ HV (66kV) ○ HV (132kV)	--- --- ---	--- PME Earth --- Underground Earth	--- ○ Pole Mounted Transformer □ Ground Mounted Transformer

**IMPORTANT NOTICES**

- This information is given as a guide only and its accuracy cannot be guaranteed. Services or recent additions to the network may not be shown.
- Cables, overhead lines & substations owned by other electricity network owners or private companies may be present and may not be shown.
- You should always verify exact locations of cables using a cable locator and by careful use of hand tools in accordance with HSE guidance note HSG47.
- When working within 10m of any overhead electric line you should follow the requirements of HSE Guidance Note GS6.
- For further advice on working near our electricity cables or lines, call our General Enquiries number.
- Advice should be sought from the National Grid Electricity Distribution General Enquiries team for any work that is to take place in proximity to 132kV underground cables and 132kV overhead lines.

**Report damage immediately – KEEP EVERYONE AWAY FROM THE AREA**  
**0800 6783 105**

Crown Copyright © All Rights Reserved. Ordnance Survey Licence numbers: 100022432  
NGED Copyright: This copy has been made by or with the authority of National Grid Electricity Distribution (NGED) pursuant to Section 47 of the Copyright Designs and Patents Act 1988 unless that Act provides a relevant exception to copyright the copy must not be copied without the prior permission of the copyright owner.

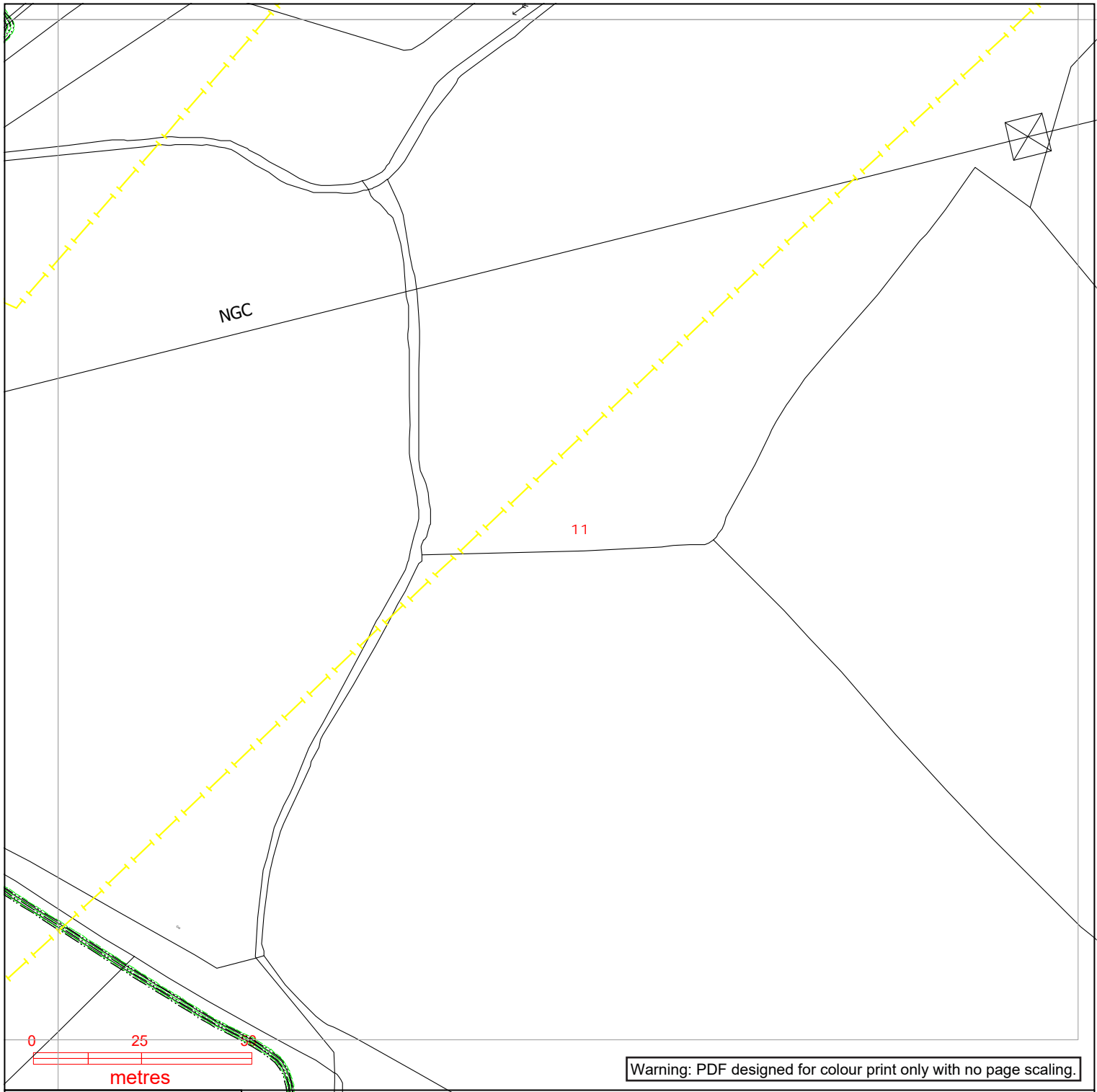

**nationalgrid** Electricity Distribution

**Contact Us**

**Mapping Enquiries:**  
All areas 0121 623 9780

**General Enquiries:**  
All areas 0800 096 3080

Date Requested: 05/12/2022  
Job Reference: 27820377  
Site Location: 264753 200956  
Requested by:  
Mr Ben Evans  
Your Scheme/Reference:  
LM 115410/DK

Exact Scales:  
1:1250 Area or Circle dig site  
1:500 Line dig site

<b>Link Box</b> ●	<b>Overhead Line</b> ○ ○ PL ○ ○ Service ○ ○ LV ○ ○ HV (11kV) ○ ○ HV (33kV) ○ ○ HV (66kV) ○ ○ HV (132kV)	<b>Underground Cable</b> -	<b>National Grid Telecoms</b> - - - - - PME Earth -E- - - - - Underground Earth	<b>Pilot Cables</b> - - - - - ○ Pole Mounted Transformer □ Ground Mounted Transformer
----------------------	--	---	---	--

**IMPORTANT NOTICES**

- This information is given as a guide only and its accuracy cannot be guaranteed. Services or recent additions to the network may not be shown.
- Cables, overhead lines & substations owned by other electricity network owners or private companies may be present and may not be shown.
- You should always verify exact locations of cables using a cable locator and by careful use of hand tools in accordance with HSE guidance note HSG47.
- When working within 10m of any overhead electric line you should follow the requirements of HSE Guidance Note GS6.
- For further advice on working near our electricity cables or lines, call our General Enquiries number.
- Advice should be sought from the National Grid Electricity Distribution General Enquiries team for any work that is to take place in proximity to 132kV underground cables and 132kV overhead lines.

**Report damage immediately – KEEP EVERYONE AWAY FROM THE AREA**  
**0800 6783 105**

Crown Copyright © All Rights Reserved. Ordnance Survey Licence numbers: 100022432  
NGED Copyright: This copy has been made by or with the authority of National Grid Electricity Distribution (NGED) pursuant to Section 47 of the Copyright Designs and Patents Act 1988 unless that Act provides a relevant exception to copyright the copy must not be copied without the prior permission of the copyright owner.



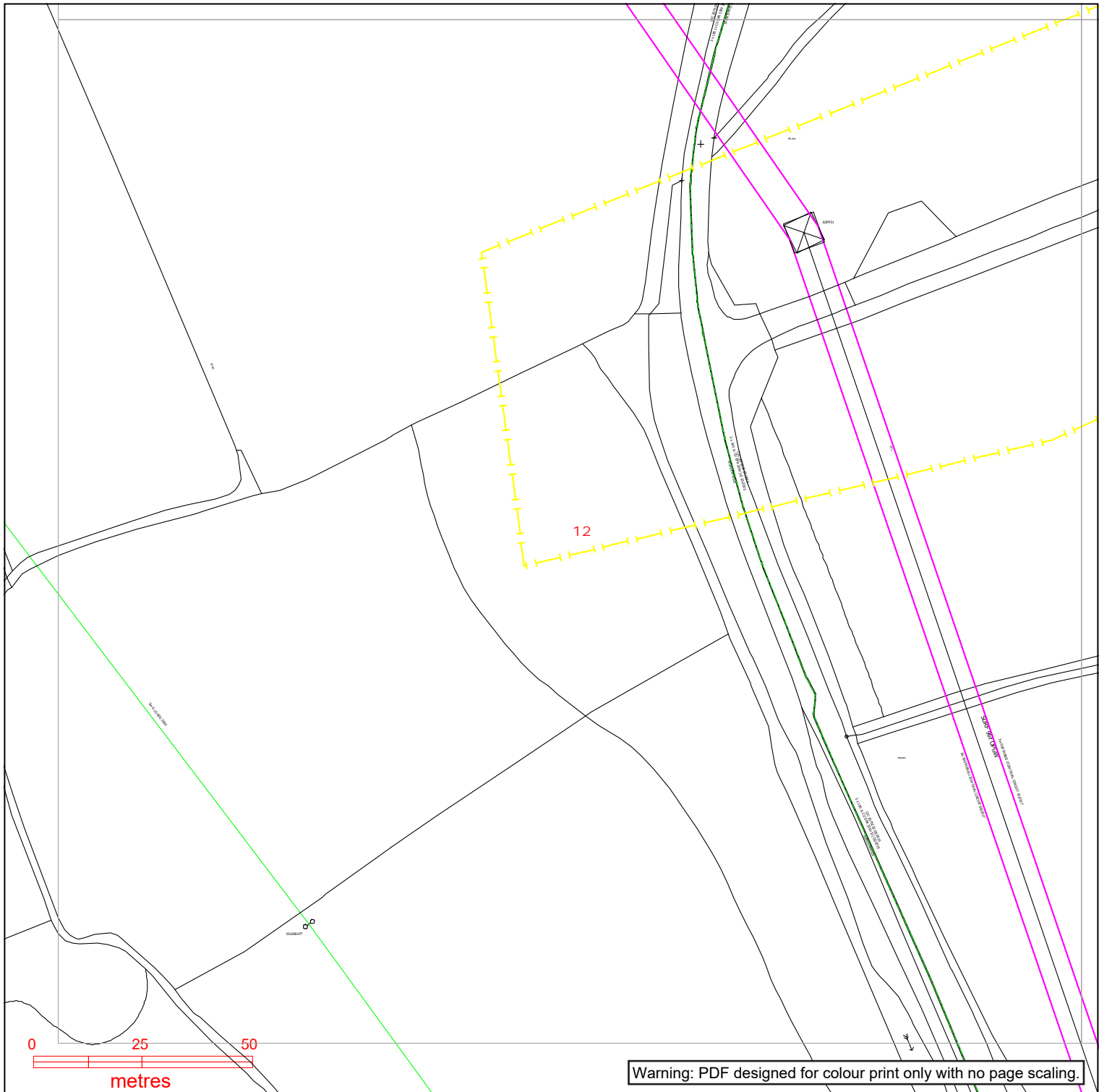

**Contact Us**

**Mapping Enquiries:**  
All areas 0121 623 9780

**General Enquiries:**  
All areas 0800 096 3080

Date Requested: 05/12/2022  
Job Reference: 27820377  
Site Location: 264753 200956  
Requested by:  
Mr Ben Evans  
Your Scheme/Reference:  
LM 115410/DK

Exact Scales:  
1:1250 Area or Circle dig site  
1:500 Line dig site

Link Box	Overhead Line	Underground Cable	National Grid Telecoms	Pilot Cables
●	○ PL ○ Service ○ LV ○ HV (11kV) ○ HV (33kV) ○ HV (66kV) ○ HV (132kV)	---	---	---
Site Location Line/Area	---	---	⏏ PME Earth ⏏ Underground Earth	⊙ Pole Mounted Transformer □ Ground Mounted Transformer

**IMPORTANT NOTICES**

- This information is given as a guide only and its accuracy cannot be guaranteed. Services or recent additions to the network may not be shown.
- Cables, overhead lines & substations owned by other electricity network owners or private companies may be present and may not be shown.
- You should always verify exact locations of cables using a cable locator and by careful use of hand tools in accordance with HSE guidance note HSG47.
- When working within 10m of any overhead electric line you should follow the requirements of HSE Guidance Note GS6.
- For further advice on working near our electricity cables or lines, call our General Enquiries number.
- Advice should be sought from the National Grid Electricity Distribution General Enquiries team for any work that is to take place in proximity to 132kV underground cables and 132kV overhead lines.

**Report damage immediately – KEEP EVERYONE AWAY FROM THE AREA**  
**0800 6783 105**

Crown Copyright © All Rights Reserved. Ordnance Survey Licence numbers: 100022432  
NGED Copyright: This copy has been made by or with the authority of National Grid Electricity Distribution (NGED) pursuant to Section 47 of the Copyright Designs and Patents Act 1988 unless that Act provides a relevant exception to copyright the copy must not be copied without the prior permission of the copyright owner.

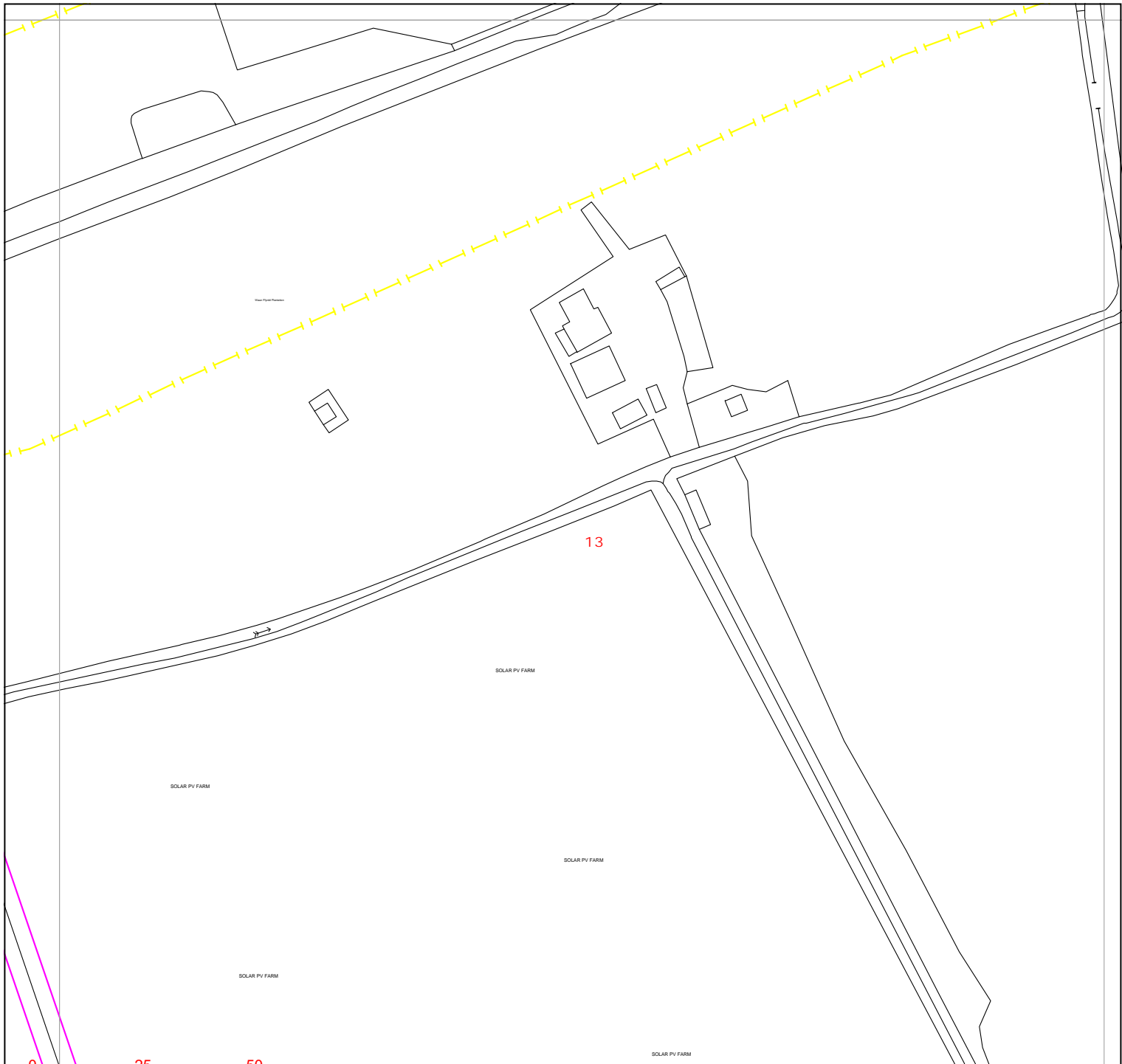

Warning: PDF designed for colour print only with no page scaling.

**nationalgrid** Electricity Distribution

**Contact Us**

**Mapping Enquiries:**  
All areas 0121 623 9780

**General Enquiries:**  
All areas 0800 096 3080

Date Requested: 05/12/2022  
Job Reference: 27820377  
Site Location: 264753 200956  
Requested by:  
Mr Ben Evans  
Your Scheme/Reference:  
LM 115410/DK

Exact Scales:  
1:1250 Area or Circle dig site  
1:500 Line dig site

<b>Link Box</b> ●	<b>Overhead Line</b> ○—○ PL ○—○ Service ○—○ LV ○—○ HV (11kV) ○—○ HV (33kV) ○—○ HV (66kV) ○—○ HV (132kV)	<b>Underground Cable</b> -	<b>National Grid Telecoms</b> - - - - - PME Earth -E- - - - - Underground Earth	<b>Pilot Cables</b> ○ □ Pole Mounted Transformer Ground Mounted Transformer
----------------------	--	---	---	---

**IMPORTANT NOTICES**

- This information is given as a guide only and its accuracy cannot be guaranteed. Services or recent additions to the network may not be shown.
- Cables, overhead lines & substations owned by other electricity network owners or private companies may be present and may not be shown.
- You should always verify exact locations of cables using a cable locator and by careful use of hand tools in accordance with HSE guidance note HSG47.
- When working within 10m of any overhead electric line you should follow the requirements of HSE Guidance Note GS6.
- For further advice on working near our electricity cables or lines, call our General Enquiries number.
- Advice should be sought from the National Grid Electricity Distribution General Enquiries team for any work that is to take place in proximity to 132kV underground cables and 132kV overhead lines.

**Report damage immediately – KEEP EVERYONE AWAY FROM THE AREA**  
**0800 6783 105**

Crown Copyright © All Rights Reserved. Ordnance Survey Licence numbers: 100022432  
NGED Copyright: This copy has been made by or with the authority of National Grid Electricity Distribution (NGED) pursuant to Section 47 of the Copyright Designs and Patents Act 1988 unless that Act provides a relevant exception to copyright the copy must not be copied without the prior permission of the copyright owner.

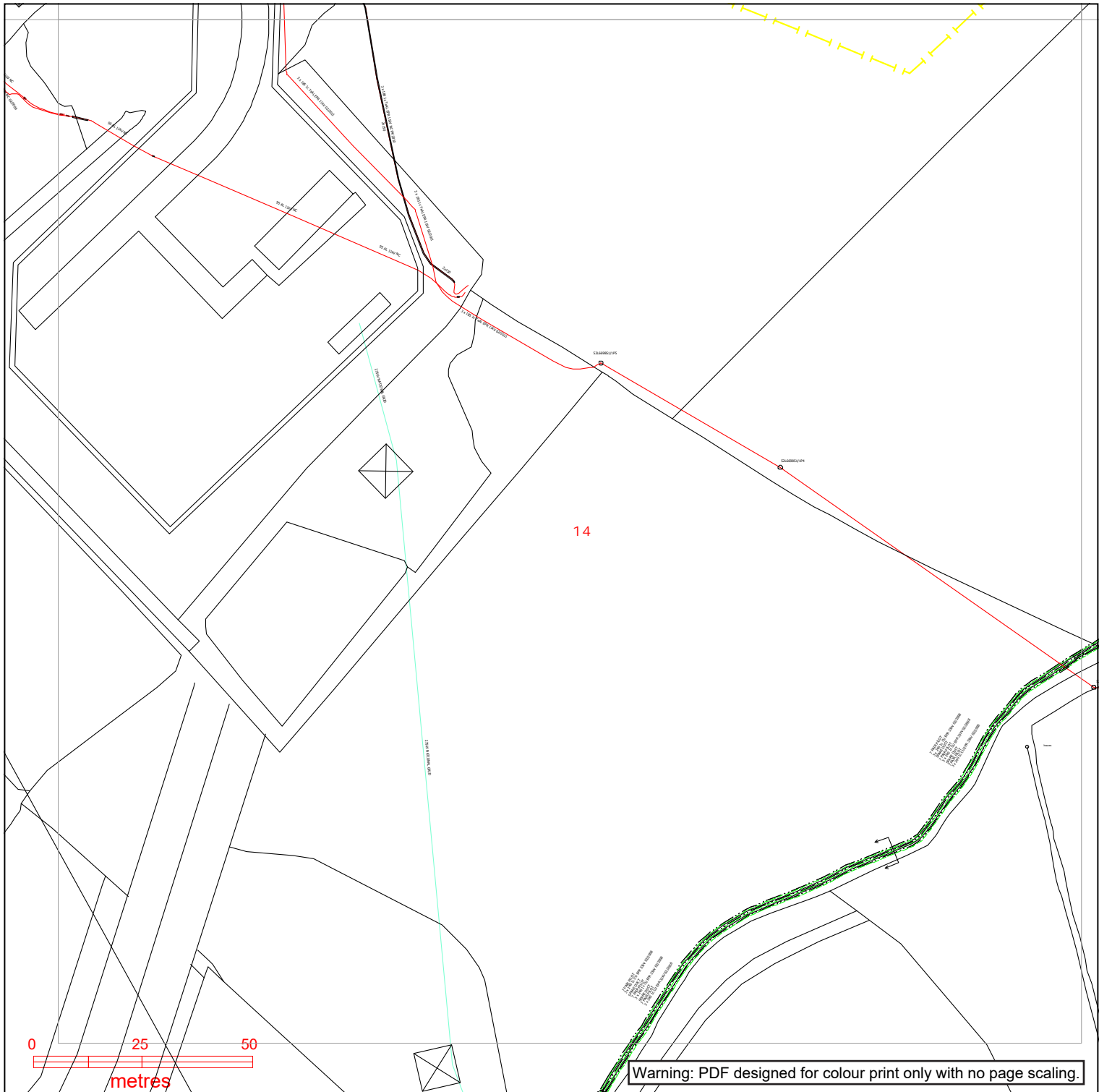

14



Warning: PDF designed for colour print only with no page scaling.

**nationalgrid** Electricity Distribution

**Contact Us**

**Mapping Enquiries:**  
All areas 0121 623 9780

**General Enquiries:**  
All areas 0800 096 3080

Date Requested: 05/12/2022  
Job Reference: 27820377  
Site Location: 264753 200956  
Requested by:  
Mr Ben Evans  
Your Scheme/Reference:  
LM 115410/DK

Exact Scales:  
1:1250 Area or Circle dig site  
1:500 Line dig site

Link Box	Overhead Line	Underground Cable	National Grid Telecoms	Pilot Cables
●	○ PL ○ Service ○ LV ○ HV (11kV) ○ HV (33kV) ○ HV (66kV) ○ HV (132kV)	---	--- PME Earth ---E Underground Earth	○ Pole Mounted Transformer □ Ground Mounted Transformer
Site Location Line/Area	--- (various colors)	---		

**IMPORTANT NOTICES**

- This information is given as a guide only and its accuracy cannot be guaranteed. Services or recent additions to the network may not be shown.
- Cables, overhead lines & substations owned by other electricity network owners or private companies may be present and may not be shown.
- You should always verify exact locations of cables using a cable locator and by careful use of hand tools in accordance with HSE guidance note HSG47.
- When working within 10m of any overhead electric line you should follow the requirements of HSE Guidance Note GS6.
- For further advice on working near our electricity cables or lines, call our General Enquiries number.
- Advice should be sought from the National Grid Electricity Distribution General Enquiries team for any work that is to take place in proximity to 132kV underground cables and 132kV overhead lines.

**Report damage immediately – KEEP EVERYONE AWAY FROM THE AREA**  
**0800 6783 105**

Crown Copyright © All Rights Reserved. Ordnance Survey Licence numbers: 100022432  
NGED Copyright: This copy has been made by or with the authority of National Grid Electricity Distribution (NGED) pursuant to Section 47 of the Copyright Designs and Patents Act 1988 unless that Act provides a relevant exception to copyright the copy must not be copied without the prior permission of the copyright owner.

A photograph of a worker in a yellow safety suit and white helmet working on a large array of red cables in a tunnel. The worker is on the right side of the frame, looking towards the camera. The cables are arranged in a long, parallel line, extending from the foreground into the background. The background is dark and appears to be the interior of a tunnel or a large underground structure. The overall scene is dimly lit, with the worker's safety gear and the red cables providing the main sources of color and contrast.

nationalgrid

## Avoidance of danger from electricity overhead lines and underground cables

National Grid Electricity  
Distribution's information  
to manage safety whilst  
working in the vicinity  
of our equipment.

[nationalgrid.co.uk](http://nationalgrid.co.uk)

**CALL 105**  



# Avoidance of danger from electricity overhead lines and underground cables

Every year in the UK on average, two people are killed and many more are injured when mechanical plant and machinery comes into contact or close proximity to overhead electricity lines.

Although electric shock is the first thing that people associate with coming into contact with our network, those who have witnessed the effects of damage to our system are shocked by the amount of heat, light and noise that are the result of an electrical flashover.

In the Midlands, South West and South Wales, National Grid Electricity Distribution (NGED) have had to attend to incidents where people have accidentally made contact with one of our live electricity overhead lines or damaged an underground cable and became seriously injured.

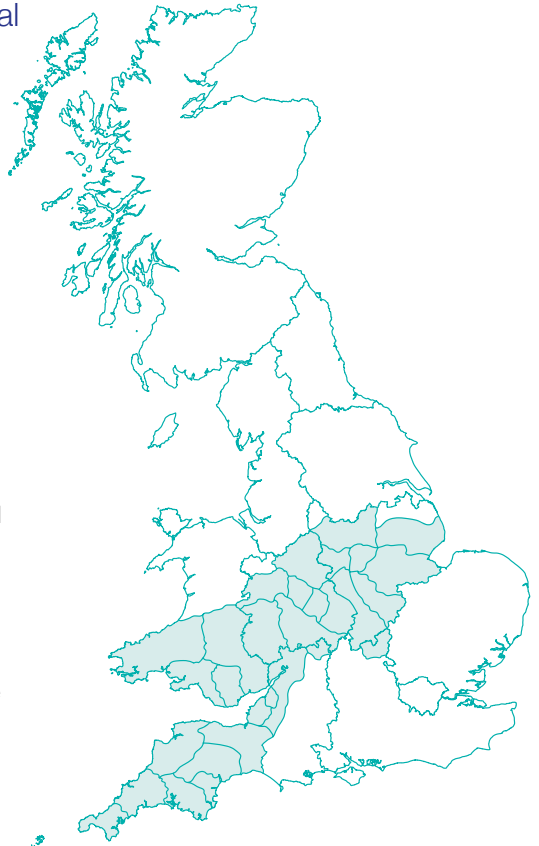
A significant number of these accidents occurred whilst people were working in the vicinity of overhead and underground electrical apparatus and this booklet has been produced to provide general guidance on how you and your employees can avoid becoming one of these statistics.



## Planning your work

It makes sense to consider your safety while in the vicinity of our equipment as early in your planning process as possible.

One of the first things you should do whenever you are planning your work is to check whether there is any of our equipment in the immediate vicinity. You should do this whether your work is taking place on public (e.g. highways and footpaths) or on private land.

Companies and organisations can request plans through LSBUD (Linesearch BeforeUdig) **lsbud.co.uk** – this site provides the same high quality plans and service that the NGED Webmap system has provided in the past, with the significant added benefit of searching over 40 other asset owners from a single query, including underground and overhead electricity networks, gas, high pressure fuel, water and fibre optic networks.

(Please note: not all asset owners are represented by LSBUD, and enquiries should also be made independently to all other relevant organisations).

This service allows you to request plans online and receive an information pack back via email within minutes.

Domestic/private customers should request plans using the phone number, email or postal address shown at the bottom of this section.

For instance, take a good look around your site to see if there are any visible overhead lines.

You should also bear in mind that we have a very extensive network of underground cables, and we are always happy to supply a plan from our Map Response Team who can be contacted via the following;

Tel:

**0121 623 9780**

Email:

**nged.mapresponse@nationalgrid.co.uk**

It is always safer to assume that there are underground cables present in the ground until you have proven otherwise.

An online mapping service is available at: **[nationalgrid.co.uk/our-network/check-before-you-dig-location-of-our-cables-and-equipment](https://nationalgrid.co.uk/our-network/check-before-you-dig-location-of-our-cables-and-equipment)**

## Working in the vicinity of underground cables

Having obtained copies of our network maps, it is important to recognise that in most cases there will be no surface indication of the presence of underground cables.



We therefore advise that you take the following actions:

- make sure that you have up-to-date copies of our cable record plans on site - not back in the office
- don't assume that these plans are to scale if they have been faxed or copied
- make sure that a competent person using a Cable Avoidance Tool (CAT) locates all of the cables shown on these plans
- mark the locations of cables on the ground surface with waterproof road paint or other permanent marker
- always assume that our cables are live unless we have informed you, in writing, otherwise
- by hand, dig trial holes to locate the exact position of all cables. Always use an insulated spade or shovel – never use a pick, fork or power tool – push the spade or shovel into the ground applying foot pressure
- look out for ducts, marker tape or tiles but do not rely on these. Even if a cable route was originally laid in a duct or with a marker tape, these may have been removed during other excavations at a later date along with all or part of the cable route
- brief all people working in the vicinity of the presence and location of all underground cables.



# Under no circumstances should you attempt to work on, or interfere with, any of our underground cables

The only people qualified to work on this equipment are our operatives; who have been specifically trained and are authorised in writing to do so.

Please also be aware that:

- cable record plans are not guaranteed to be completely accurate. Kerb lines, roads and buildings may have been moved or altered since the cables were laid
- cables should ordinarily be at least 450mm deep, but don't assume this to be the case where you are working – ground levels could have changed
- not all service cables are shown on record plans, so look for cables running down poles and bear in mind that all buildings, street lights and street furniture are likely to have cables running to them. Cables feeding street furniture may be relatively shallow near to the furniture
- cables do not run in straight lines. They often “snake” through the ground avoiding surface and buried obstacles that may not be visible to you
- cables are flexible and can change direction and depth abruptly – for this reason never use mechanical excavators within 0.5m of any underground electricity cable even if you have located it with trial holes
- **no attempt should be made to break out concrete surrounding a cable. Please contact us immediately on our general enquiries number and we will discuss the options for safe working which may include making the cable dead or you moving your work site if possible. If we need to make the cable dead we may need to provide our customers with two weeks notice of the power interruption**
- our cables and joints are not designed to act as steps or to be left unsupported. If you remove support from any cable, you will need to support it using temporary hangers at not more than 0.5m intervals.
- when backfilling, please consolidate the ground under the cables, cover the cable with soil free of stones or with stone dust and replace any cable marker tiles, ducts and tape.





## If you damage an underground cable

You must immediately clear the area of personnel because the cable could still be live, or become live again.

If a machine is still in contact with the cable, instruct the driver to jump clear of the vehicle, avoiding simultaneous contact with any part of the machine and the ground. Try to land with your feet as close together as possible.

Where possible, continue to move away from the vehicle using “bunny hops” with your feet together until at least 15m from the vehicle.

Please contact us on our emergency number immediately and tell us what has happened. Please be ready to provide us with a contact telephone number and an accurate location or set of directions – this will help us in getting our staff to site quickly to minimise any danger and lessen the disruption to your work.

Incident locations can be hard to describe. Using the free What3Words app will enable us to quickly and easily identify where the incident has taken place across our network.

### CALL 105



Please report any damage to a cable, however superficial it might seem. The cable may not fail at the time of damage, but it could fail later, causing danger to our staff and other contractors, disruption to our customers’ supplies, and also – if we trace the damage back to you – a large repair bill.

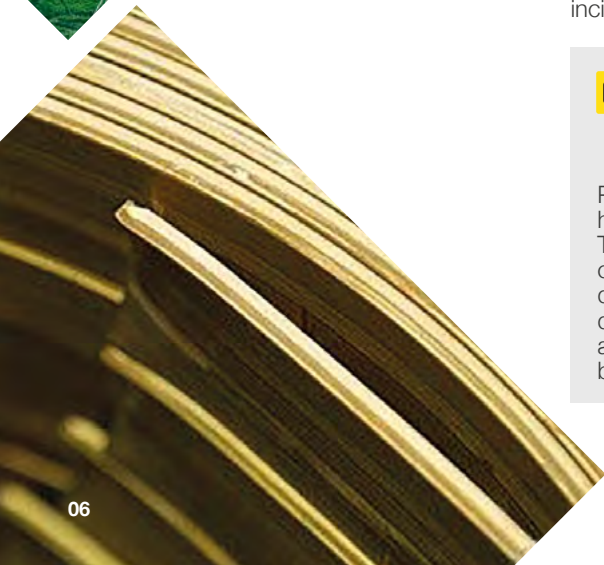

## Working in the vicinity of overhead lines

Under no circumstances should you attempt to work on, or interfere with any of our overhead line equipment or service wires.

The only people qualified to work on this equipment are our operatives; who have been specifically trained and are authorised in writing to do so. Overhead lines have the advantage that, unlike underground cables, they can easily be seen.

- Always assume that our overhead lines are live unless we have informed you otherwise in writing.
- We will be able to advise you about the type and voltage of the overhead lines in question and provide you with information about the clearances that you must adhere to during your work. Please ring our regional general enquiries number for further advice.
- In some circumstances, we may be able to temporarily shroud low voltage overhead lines and services running to buildings if you need to work in the vicinity e.g. for scaffolding erection, fascia repairs and painting work on domestic properties. We don't normally charge for the shrouding of overhead lines, but please give us as much notice as possible.
- If you think that you will be working close to our overhead lines and they need shrouding – please don't start work until we have agreed what needs to be done and all safety precautions are in place.
- If you are in any doubt about whether the overhead lines in question are power or telephone (this is a very common mistake) – please ask us.
- Please note that it is not technically possible to shroud high voltage lines, so if you cannot avoid working near to our high voltage lines, contact us and we will be happy to meet with you to discuss safe alternatives.

- If it is decided that work can go ahead in the vicinity of our overhead lines but there is a risk of you infringing the safety clearances from the overhead lines, you have a responsibility to erect safety barriers to segregate your works from the area around the overhead lines. The detailed requirements for these barriers are provided in the HSE document GS6 'Avoidance of Danger from Overhead Lines'. As a summary they should consist of:
  - red and white coloured posts erected at 6m intervals, with coloured bunting stretched between their tops, supplemented by low level bunting erected at 1m above ground level, supported at 3m intervals on red and white coloured posts. This is shown below.
- We are able to advise you on the height of the barriers and any additional clearances necessary if you are using large plant on your site.
- Any bunting, ropes and lanyards used should be made from an insulating material.
- These barriers should be erected parallel to the overhead line at a minimum distance of 6m horizontally from the outermost conductor of the overhead line.
- The supports may be supported by rubble or concrete filled barrels or buried directly in the ground.
- Danger notices should be fixed to all of your high level supports.
- The ground enclosed within these barriers is best regarded as "dead ground" in which all foot and vehicular traffic is forbidden, in all circumstances, for the duration of your work.

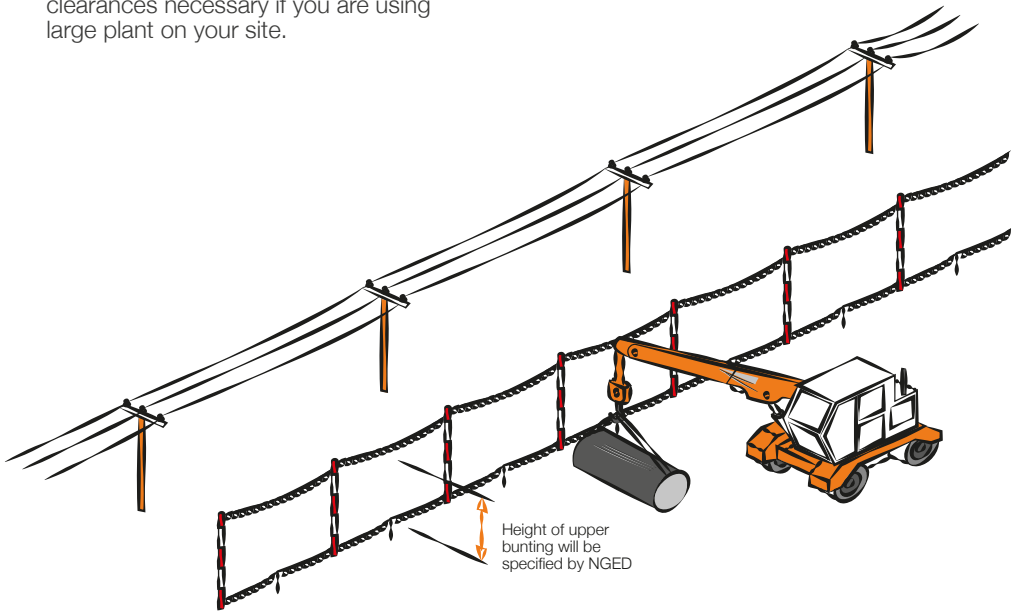

- Where it is necessary for foot and vehicular traffic to pass under the line, you will need to form a marked access way between the barriers as shown below.
- This access way should comprise of bunting erected 1m above ground, supplemented by high level “goal-posts” erected at either end.
- The goal post cross bars should be rigid, made of insulating material and positioned in a location and at a height specified by us.
- The access route should be as narrow as possible and should not normally exceed 10m in width.
- If it is necessary to make the access route wider than this, you may find it impractical to use rigid cross bars, so you may use a tensioned rope and bunting instead. If you use rope and bunting as a cross bar, you should move the entrance to the access route out to a minimum distance of 12m from the outermost conductor of the line. This is to allow for any stretching of the rope if pulled by your plant.

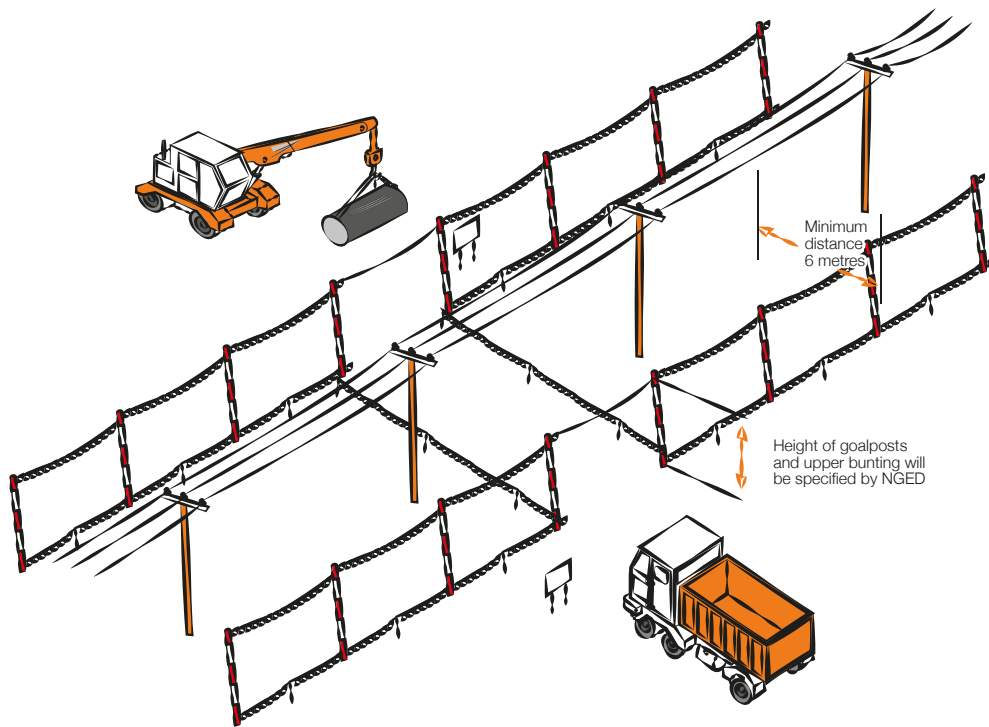

- If you decide to use steel wire rope to support the barrier, this must be effectively connected to earth at both ends.
- You should also install Danger Notices at all probable directions of approach and clearly display the cross bar height.
- Whatever measures you take, you should ensure that everyone working in the vicinity of overhead lines is briefed about the risks and what safety measures are in place. Do not permit anyone to carry long objects, especially scaffold poles, ladders and irrigation pipes in the vicinity of overhead lines.
- If you are working at night, or in conditions of poor visibility, you should ensure the area is well lit and that the overhead lines are clearly visible.
- You should ensure that all shrouding, barriers and signs are regularly inspected and maintained so that they remain effective.
- Overhead lines are not normally insulated and electricity at high voltages may jump, so a dangerous situation can arise just from a close approach.
- Cranes and excavators working near overhead lines are at increased risk because of the possibility of the jib/arm slewing or being raised into the overhead line, or the load swinging into the overhead line. You may therefore also need to fit plant and vehicles with restricting chains etc. to physically restrain their operation – we can advise on this if you wish.
- If you are planning to carry out tree cutting or arboriculture work in the vicinity of our overhead lines, you need to be aware that this is a complex, high risk activity and we recommend that you employ a competent tree surgeon, who complies with all of the requirements of Forestry industry Safety Accord (FISA) publication FISA 804 - Electricity at work: Forestry.

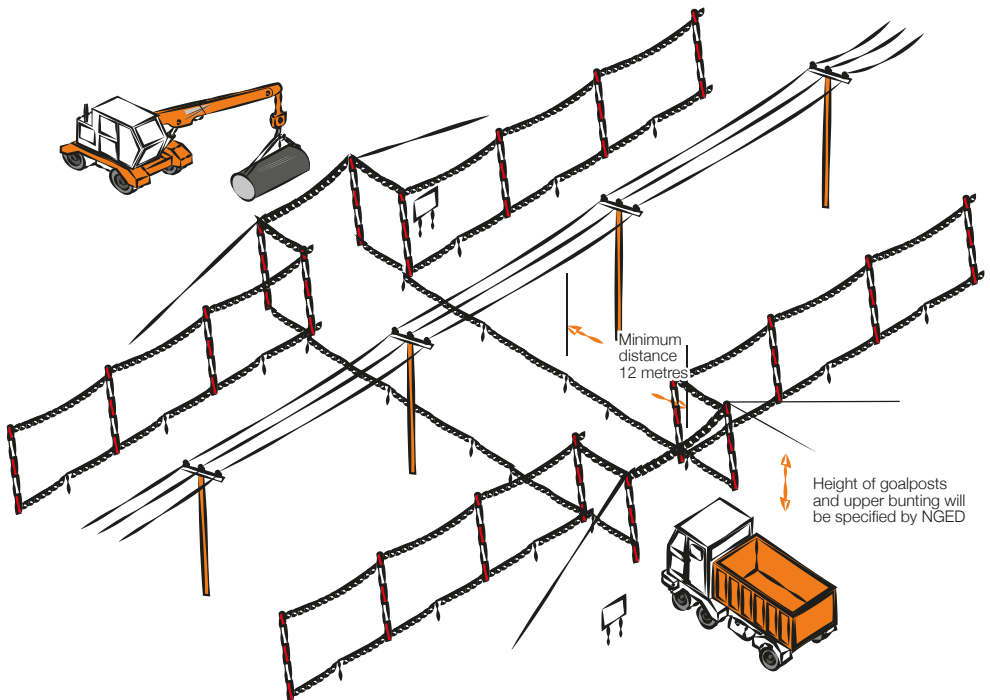

## If contact is made with an overhead line

You must immediately clear the area and suspend all work within 50m of the damage because the line could still be live, or become live again. The operator of a machine that is in contact with an overhead line should:

- **If the machine is still operable and the operator is still in the cab:**
  - provided that you do not risk breaking the overhead line or dragging it to the ground, immediately lower the raised parts of the machine using only the controls in the cab and/or drive the vehicle clear of the overhead line
  - contact us immediately on our emergency number so that we can check the overhead lines
  - instruct other people in the vicinity not to approach the vehicle.
- **If the machine is not operable, cannot be driven clear of the overhead line or there is a risk that doing so will break the line or drag it to the ground:**
  - stay in the cab
  - contact your site manager or us immediately on our emergency number by radio or mobile phone or as soon as possible by any other method
  - instruct everyone outside the vehicle not to approach it
  - do not exit the cab until given confirmation by wpd personnel that it is safe to do so.

- **If the machine is inoperable or cannot be driven free and there is risk of fire or other immediate hazard:**

- jump clear of the vehicle, avoiding simultaneous contact with any part of the machine and the ground
- try to land with your feet as close together as possible
- where possible, continue to move away from the vehicle jumping with both feet together until at least 15m from the vehicle. Instruct other people in the vicinity not to approach the vehicle. Contact us immediately on our emergency number
- do not return to the vehicle until given confirmation by wpd personnel that it is safe to do so.

Whatever the circumstances please contact us on our emergency number immediately and tell us what has happened. Please be ready to provide us with a contact telephone number and an accurate location or set of directions – this will help us in getting our staff to site quickly to minimise any danger and lessen any disruption to your work.

### CALL 105



Please report any damage or contact no matter how minor they may seem to you at the time. The damage may not cause a serious problem at the time of damage, but it could fail later, causing danger to our staff and members of the public, disruption to our customers' supplies, and – if we trace the damage back to you – a large repair bill.

## More information

For your information, we are legally obliged to report all contact with our system to the Health and Safety Executive (HSE), and, if you are an employer, you may be obliged to report incidents involving your staff or contractors to the HSE.

Even if no one is hurt, you could be prosecuted for failing to report such an incident.

More detailed general information on this subject is available in the following publications from the HSE:

- HSG(47) – Avoiding Danger from Underground Services
- GS6 – Avoidance of Danger from Overhead Lines
- along with Forestry Industry Safety Accord (FISA) publication FISA 804 – Electricity at Work: Forestry

If you require more site-specific information relating to our equipment at your location please contact us on our general enquiry number:

Our general enquiry number is:

**0800 096 3080**

National Grid Electricity Distribution plc  
Avonbank  
Feeder Road  
Bristol BS2 0TB  
United Kingdom

[nationalgrid.co.uk](https://www.nationalgrid.co.uk)

## Finally

Please, always remember that electricity cables and overhead lines can be very dangerous – the general rule is **stay away and stay safe.**

nationalgrid

# Look out, look up!

National Grid Electricity Distribution's  
guide to the safe use of mechanical  
plant in the vicinity of electricity  
overhead lines



[nationalgrid.co.uk](http://nationalgrid.co.uk)

**CALL 105**



# The safe use of mechanical plant in the vicinity of electricity overhead lines

**Every year in the UK on average, two people are killed and many more are injured when mechanical plant and machinery comes into contact or close proximity to overhead electricity lines.**

This booklet has been produced for anyone who uses mobile plant, (such as Hiabs, MEWPs, tipper lorries and trailers, grab lorries, concrete conveyors and excavators) for short duration work and provides general guidance on how to avoid becoming part of these statistics.

## 1 Before starting work

Overhead lines have the advantage that they can easily be seen, so before you set up your vehicle or plant always:

### Stop and look up!



If you are working at night, or in conditions of poor visibility, you should use spotlights or a torch to carefully check that there are no overhead lines within your vehicle's reach.



If you are in any doubt about whether the lines in question are power or telephone (this is a very common mistake) – always assume that they are power lines and are live.

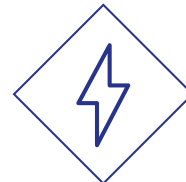

It is not normally practical for electricity companies to shroud high voltage conductors and even when low voltage conductors are shrouded, the shrouding is not designed to protect against contact by mechanical plant – again, always assume the lines are live.

---

## 2 Exclusion zones

Overhead power lines are not normally insulated and so any contact can result in serious or fatal injuries. Electricity at high voltages can also jump gaps with no warning whatsoever, so it is also dangerous to let your plant approach too close to a line. The distance that electricity can jump depends on the voltage of the line.

The higher the voltage, the further you must stay away from the line and any other equipment that may be fitted to the pole or pylon. This distance is called the **exclusion zone**. Examples of this are shown highlighted in the diagram below.

Exclusion zones are shown in blue

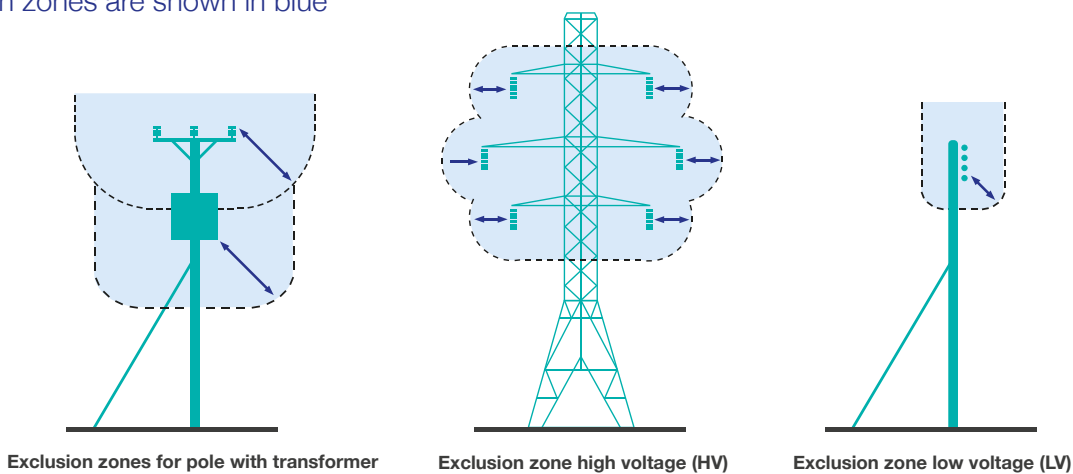

You must not allow any part of your plant to enter the **exclusion zone**. The diagram below shows typical types of overhead lines and provides a guide to help

you assess the line voltage of lines on wooden poles or steel pylons. The minimum **exclusion zone distance** is shown for each example.

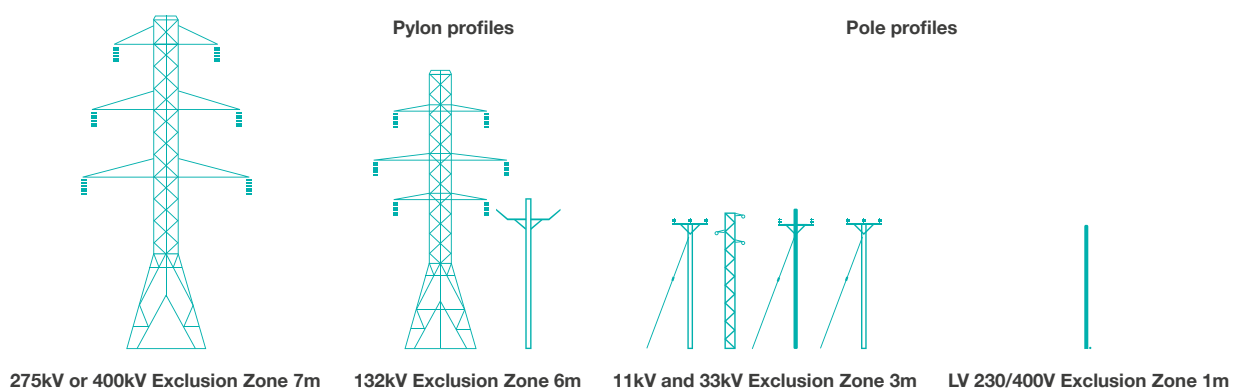

Please note that these are absolute minimum distances that should under no circumstances be infringed. If you do – it could prove fatal. As well as staying away from the lines or equipment, you should also stay at least

600mm away from any part of poles, pylons and stay wires. Please remember that is for guidance only, and if you are in any doubt, please call us for advice before setting up your plant or starting work.

### 3 Stand off distances

If there are power lines in the vicinity of your work the best way to make sure you stay out of the **exclusion zone** is to position your vehicle at a **safe stand off distance** so that, even when fully extended, no part of it can accidentally reach inside the **exclusion zone**.

This **safe stand off distance** can be calculated by adding the **exclusion zone** distance for the appropriate voltage of the line to the **maximum operating reach** of your vehicle.

**This is shown in the diagram opposite.**

If you position your vehicle outside of the **safe stand off distance**, there is no risk of accidental contact with the lines and no danger of electricity jumping from the line to your vehicle.

If you cannot achieve a **safe stand off distance**, consider moving your vehicle to a safer location.

It may make your job a bit more difficult, but if it means you stay away from the **exclusion zone** - it will be safer.

The next best option would be to consider using smaller plant with a **maximum operating reach** that cannot enter the **exclusion zone**.

You may not be able to achieve either of these options, so, as a last resort, if you cannot avoid operating large items of plant in the vicinity of lines, you must make sure that the plant is fitted with restraints to ensure that the **exclusion zone** cannot be entered.

These restraints may be electrical or hydraulic systems fitted to the plant, or mechanical devices such as chains.

Please seek advice from the plant manufacturer for more information on choices available for your particular item of plant. If you are using a mechanical excavator to dig parallel to the line, it is good practice to position the excavator with the tracks or wheels parallel to the line, so as you move along the excavation the safe stand off distance is easily maintained.

Care must also be taken to avoid non mechanical equipment, (e.g. scaffold poles, ladders and long loads such as lengths of steel or timber) from entering the exclusion zone.

Always maintain at least 600mm clearance from your plant to any of our poles, stay wires or pylons. Any contact with these by your plant could cause the line to break and fall to the ground.



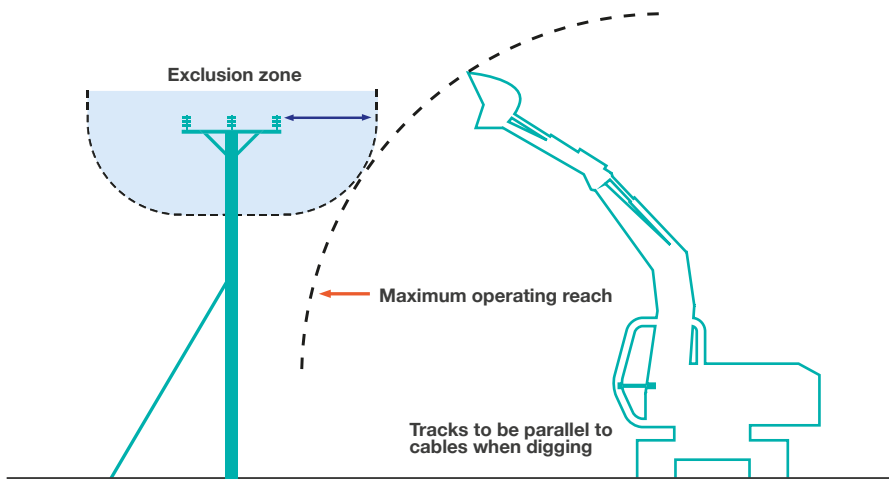
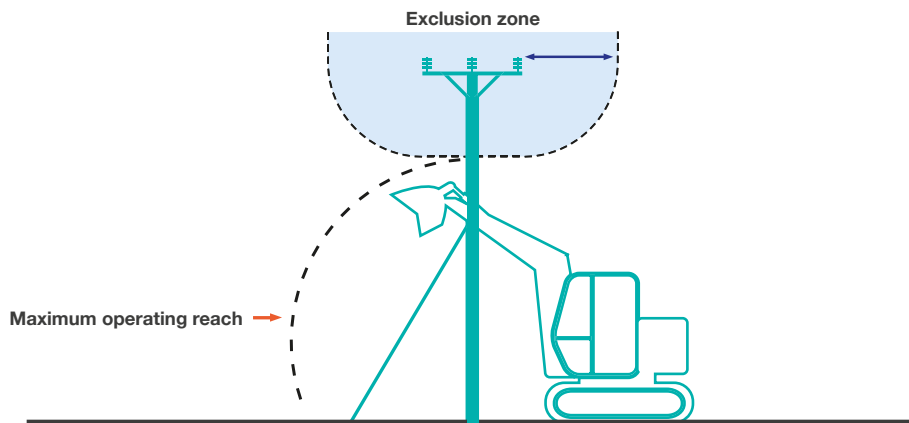
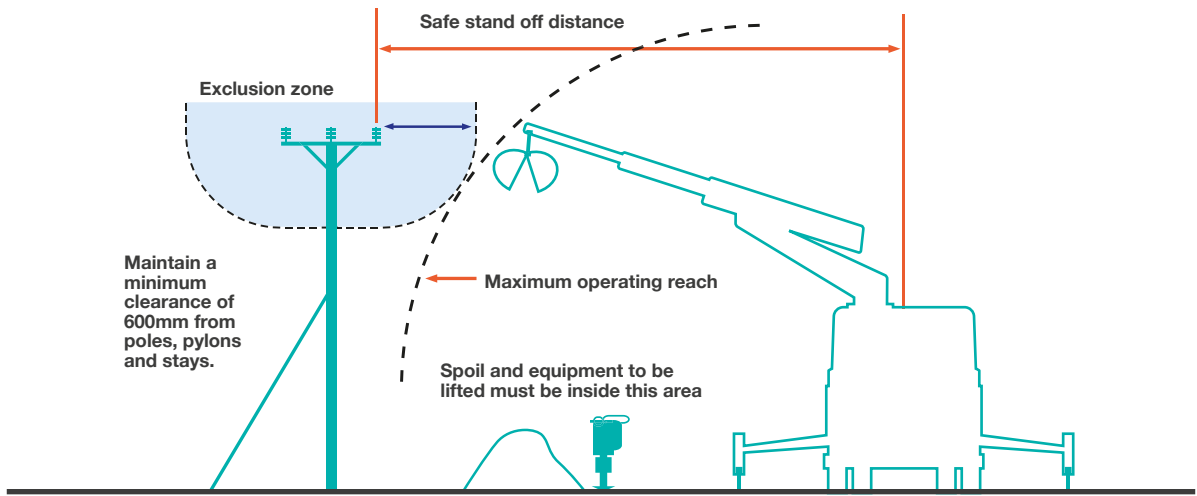

## 4 Emergency procedures

**If contact is made with an overhead line, you must immediately clear the area and suspend all work within 50m of the damage because the line could still be live, or become live again.**

The operator of a machine that is in contact with an overhead line should take the following steps:

**If the machine is still operable:**

- lower any raised parts that are controlled from the driving position and/or drive the vehicle clear of the line, as long as neither of these actions risk breaking the line or dragging it to the ground.

**If the machine is not operable or cannot be driven clear of the line:**

- stay in the cab
- contact your site manager or us immediately by radio or mobile phone or as soon as possible by any other method
- instruct everyone outside the vehicle not to approach it
- do not exit the cab until given confirmation by National Grid Electricity Distribution personnel that it is safe to do so.

**If the machine is inoperable or cannot be driven free and there is risk of fire or other immediate hazard:**

- jump clear of the vehicle, avoiding simultaneous contact with any part of the machine and the ground
- try to land with your feet as close together as possible
- where possible, continue to move away from the vehicle using “bunny hops” with your feet together until at least 15m from the vehicle
- instruct other people in the vicinity not to approach the vehicle
- do not return to the vehicle until given confirmation by National Grid Electricity Distribution personnel that it is safe to do so.

**Whatever the circumstances please contact us on our emergency number immediately and tell us what has happened.**

Please be ready to provide us with a contact telephone number and an accurate location or set of directions – this will help us in getting our staff to site quickly to minimise any danger and to reduce any disruption to your work.

**Our emergency number is:  
105 or 0800 6783 105**

Please report any damage or contact no matter how minor they may seem to you at the time.

Whilst the damage may not cause a serious problem at the time of contact it could fail later, causing danger to our staff and members of the public, disruption to our customer’s supplies, and – if we trace the damage back to you – a larger repair bill!

**CALL 105**



## 5 More information

**Proximity Warning Systems (such as Wire Watcher – see [wirewatcher.co.uk](http://wirewatcher.co.uk) for information) may be fitted to your vehicle. Never turn these devices off or disable them in any way.**

Take note of any warnings these proximity warning systems may provide but do not use the presence of such devices as a reason not to follow the advice provided in this leaflet.

For your information, we are legally obliged to report all contact with our system to the Department of Trade and Industry (DTI), and, if you are an employer, you may be obliged to report incidents involving your staff or contractors to the Health & Safety Executive (HSE). Even if no one is hurt, you could still find yourself being prosecuted for causing a dangerous occurrence.

## 6 Further reading

For advice related to signing and guarding at longer term work sites please also refer to National Grid Electricity Distribution booklet “Avoidance of Danger from Electricity Overhead Lines and Underground Cables”. More detailed information is also published in the following documents available from the HSE.

**GS6 – Avoidance of Danger from Overhead Lines.**

**HS(G) 47 – Avoiding Danger from Underground Services.**

Along with Forestry Industry Safety Accord (FISA) publication **FISA 804 - Electricity at Work: Forestry.**



If you require more site-specific information relating to our equipment at your location please contact us on the relevant **general enquiries number:**

**0800 096 3080**

**Finally...** please, always remember that electricity overhead lines can be very dangerous – **the general rule is stay away and stay safe!**



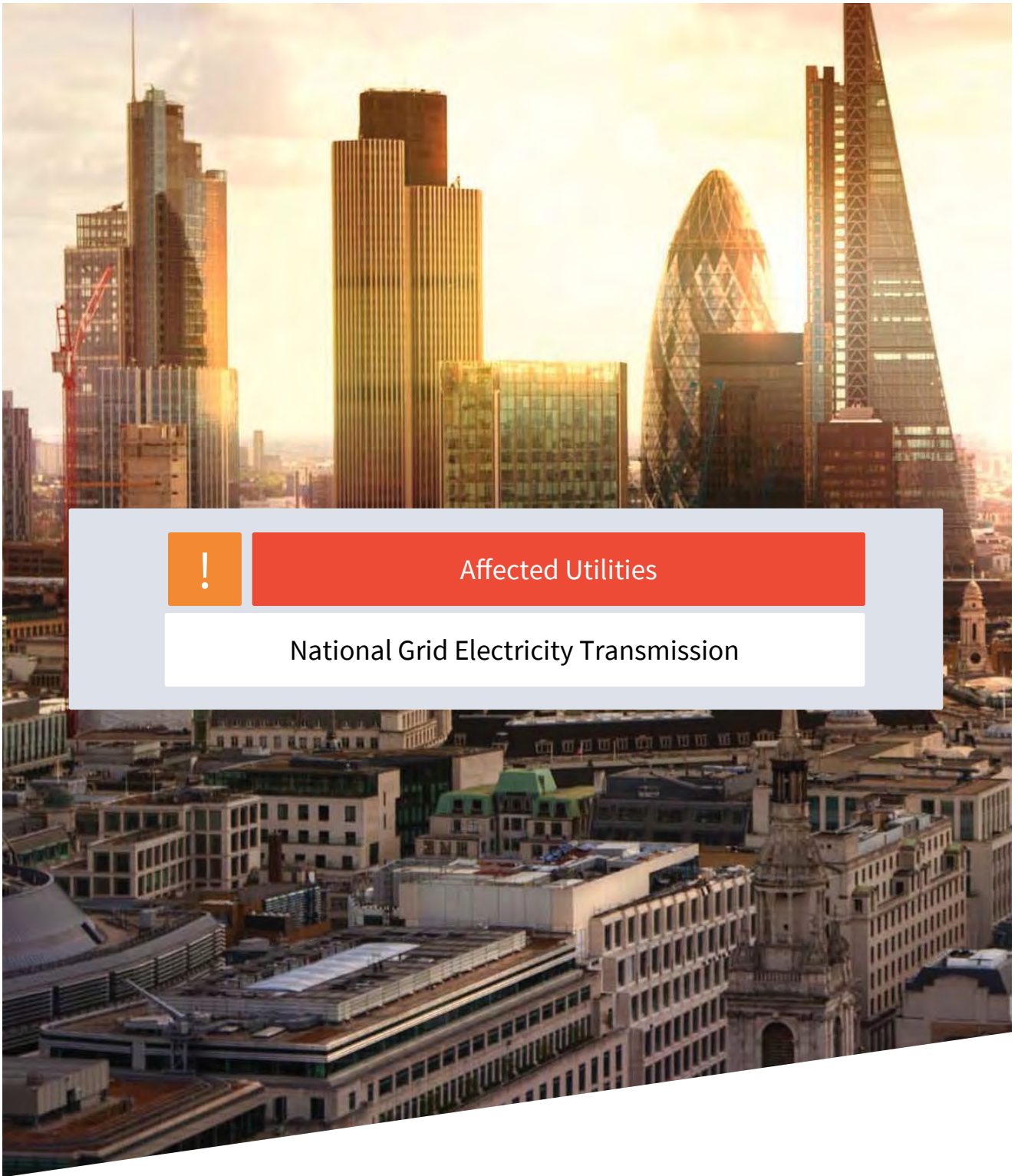

Affected Utilities

National Grid Electricity Transmission





Our Ref: 27820377 LM 115410/DK

Monday, 05 December 2022

Ben Evans  
The Hub, 500 Park Avenue, Aztec West

Bristol  
BS32 4RZ

National Grid House  
Warwick Technology Park  
Gallows Hill, Warwick  
CV34 6DA

**Electricity Emergency Number:**  
**0800 40 40 90\***  
\*Available 24 hours, 7 days/week.  
Calls may be recorded and monitored.  
[www.nationalgrid.com](http://www.nationalgrid.com)

Asset Protection  
Electricity Transmission  
National Grid  
Warwick  
Email: [assetprotection@nationalgrid.com](mailto:assetprotection@nationalgrid.com)

### National Grid Electricity – Small Scale Works - Initial Enquiry

Dear Sir/ Madam,

An assessment has been carried out with respect to National Grid Electricity Transmission plc's apparatus and the proposed work location. Based on the location entered into the system for assessment the area has been found to be within the High Risk zone from National Grid Electricity Transmission plc's apparatus and **Must Not Proceed** without further assessment by Asset Protection.

As you have entered an **Initial enquiry** please could you ensure that you submit a **Planned works enquiry** in Line Search (LSBUD) with a works description (including how deep you are excavating) at least **4 weeks** ahead of your scheduled start date. Once you receive the LSBUD Planned works response please submit plans to following email address [assetprotection@nationalgrid.com](mailto:assetprotection@nationalgrid.com) including the LSBUD reference number.

If you require any additional information at this stage such as Overhead Line profile drawings please contact [assetprotection@nationalgrid.com](mailto:assetprotection@nationalgrid.com) including the LSBUD reference number.

Failure to submit a Planned enquiry and requested information will result in a delay to your works being assessed.

***Please do not commence with any works until you have been contacted by National Grid.***

Please note this response and any attached map(s) are valid for 28 days from the date of this letter.

Yours sincerely,

Asset Protection

## Your Responsibilities and Obligations

The "Assessment" Section below outlines the detailed requirements that must be followed when planning or undertaking your activities at this location.

It is your responsibility to ensure that the information you have submitted is accurate and that all relevant documents including links are provided to all persons (either direct labour or contractors) working for you near National Grid Electricity Transmission plc's apparatus, e.g. as contained within the Construction (Design and Management) Regulations.

This assessment solely relates to National Grid Electricity Transmission plc (NGET)

This assessment does **NOT** include:

- National Grid's legal interest (easements or wayleaves) in the land which restricts activity in proximity to National Grid's assets in private land. You must obtain details of any such restrictions from the landowner in the first instance and if in doubt contact Asset Protection.
- Recently installed apparatus
- National Grid Gas plc.
- Apparatus owned by other organisations, e.g. Cadent, other gas distribution operators, local electricity companies, other utilities, etc.

It is **YOUR** responsibility to take into account whether the items listed above may be present and if they could be affected by your proposed activities.

This communication does not constitute any formal agreement or consent for any proposed development work; either generally or with regard to National Grid Electricity Transmission plc easements or wayleaves nor any planning or building regulations applications.

National Grid Electricity Transmission plc or their agents, servants or contractors do not accept any liability for any losses arising under or in connection with this information. This limit on liability applies to all and any claims in contract, tort (including negligence), misrepresentation (excluding fraudulent misrepresentation), breach of statutory duty or otherwise. This limit on liability does not exclude or restrict liability where prohibited by the law nor does it supersede the express terms of any related agreements.

If you require further assistance please contact the Asset Protection team via e-mail ([assetprotection@nationalgrid.com](mailto:assetprotection@nationalgrid.com)) or via the contact details at the top of this response.

## Assessment

### Affected Apparatus

The apparatus that has been identified as being in the vicinity of your proposed works is:

- Electricity Transmission Overhead Line apparatus.
- Electricity Transmission Underground Cables and associated apparatus.
- Substation above ground electricity sites.

### Requirements

#### Over Head Lines

BEFORE carrying out any work you must:

(N.B. Works only to be undertaken when contact has been made and response received from Asset Protection)

- Carefully read these requirements including the attached guidance documents and maps showing the location of apparatus.
- Contact the landowner and ensure any proposed works in private land do not infringe National Grid Electricity Transmission plc's legal rights (i.e. easements or wayleaves). If the works are in the road or footpath the relevant local authority should be contacted.
- Ensure that all persons, including direct labour and contractors, working for you on or near National Grid Electricity Transmission plc's apparatus follow the requirements of the HSE Guidance Notes HSG47 - 'Avoiding Danger from Underground Services' and GS6 – 'Avoidance of danger from overhead electric power lines'. This guidance can be downloaded free of charge at [www.hse.gov.uk](http://www.hse.gov.uk)
- In line with the above guidance, verify and establish the actual position of mains, pipes, cables, services and other apparatus on site before any activities are undertaken.

DURING any work you must:

- Comply with all guidance for working within the vicinity of overhead lines as detailed within the guidance documents listed below.
- Comply with all guidance relating to general activities and any specific guidance for each asset type as specified in the Guidance Section below.
- Ensure that access to National Grid Electricity Transmission plc's apparatus is maintained at all times.
- Prevent the placing of heavy construction plant, equipment, materials or the passage of heavy vehicles over National Grid Electricity Transmission plc's apparatus unless specifically agreed with National Grid Electricity Transmission plc's apparatus in advance.
- Exercise extreme caution if slab (mass) concrete is encountered during excavation works as this maybe protecting or supporting National Grid Electricity Transmission plc's apparatus.

### Underground Cables

BEFORE carrying out any work you must:

(N.B. Works only to be undertaken when contact has been made and response received from Asset Protection)

- Refer to the attached cable profile drawings which provide details about the location of National Grid's high voltage underground cables.
- Carefully read these requirements including the attached guidance documents and maps showing the location of apparatus.
- Contact the landowner and ensure any proposed works in private land do not infringe National Grid Electricity Transmission plc's legal rights (i.e. easements or wayleaves). If the works are in the road or footpath the relevant local authority should be contacted.
- Ensure that all persons, including direct labour and contractors, working for you on or near infringe National Grid Electricity Transmission plc's follow the requirements of the HSE Guidance Notes HS(G)47 "Avoiding Danger From Underground Services". This guidance can be downloaded free of charge at [www.hse.gov.uk](http://www.hse.gov.uk)
- In line with the above guidance, verify and establish the actual position of mains, pipes, cables,

National Grid is a trading name for:

National Grid Electricity Transmission plc

Registered Office: 1-3 Strand, London WC2N 5EH

Registered in England and Wales, No 2366977

services and other apparatus on site before any activities are undertaken.

DURING any work you must:

- Comply with all guidance for working within the vicinity of Electricity Underground Cables as detailed within the guidance documents listed below.
- Comply with all guidance relating to general activities and any specific guidance for each asset type as specified in the Guidance Section below.
- Ensure that access to National Grid Electricity Transmission plc's apparatus is maintained at all times.
- Prevent the placing of heavy construction plant, equipment, materials or the passage of heavy vehicles over National Grid Electricity Transmission plc's apparatus unless specifically agreed with National Grid Electricity Transmission plc's in advance.
- Exercise extreme caution if slab (mass) concrete is encountered during excavation works as this maybe protecting or supporting National Grid Electricity Transmission plc's apparatus.

## GUIDANCE

National Grid is a trading name for:  
National Grid Electricity Transmission plc  
Registered Office: 1-3 Strand, London WC2N 5EH  
Registered in England and Wales, No 2366977

## National Grid Electricity Transmission Network data

- The Network map for National Grid Electricity Transmission assets can be downloaded at the following link in GIS format.

<https://www.nationalgrid.com/uk/electricity-transmission/network-and-infrastructure/network-route-maps>

### **Buried Cables**

- National Grid's underground cables are protected by a Deed of grant; Easement; Wayleave Agreement or the provisions of the New Roads and Street Works Act. Which provide full right of access to retain, maintain, repair and inspect our asset. Hence we require that no permanent structures are to be built over our cables or within the easement strip.
- Ground levels above our cables must not be altered in any way. Any alterations to the depth of our cables will subsequently alter the rating of the circuit and can compromise the reliability, efficiency and safety of our electricity network.
- The supplied detailed route records should not be taken as positive indication of the cable location. This can only be determined by digging trial holes. Where trial holes are dug the concrete and / or polymeric cable protection tiles must not be disturbed.
- The normal recommendation is to keep 2 metres clear either side of the 1 metre wide trench containing the AC cable.
- National Grid should be made aware of the works starting and may put in place a representative to monitor the works. The works should be carried out in accordance with the recommendations in document HS (G) 47 available from the HSE web site.
- The relocation of existing underground cables is not normally feasible on grounds of cost, operation and maintenance and environmental impact and we believe that successful development can take place in their vicinity.
- The information supplied is given in good faith and only as a guide to the location of our underground cables. The accuracy of this information cannot be guaranteed. The physical presence of such cables may also be evident from physical protection measures such as ducts or concrete protection tiles. The person(s) responsible for planning, supervising and carrying out work in proximity to our cable(s) shall be liable to us, as cable(s) owner, as well as to any third party who may be affected in any way by any loss or damage resulting from their failure to locate and avoid any damage to such a cable(s).
- The relevant guidance in relation to working safely near to existing underground cables is contained within the Health and Safety Executive's ([www.hse.gov.uk](http://www.hse.gov.uk)) Guidance HS(G)47 "Avoiding Danger From Underground Services" and all relevant site staff should make sure that they are both aware of and understand this guidance.
- Our cables are normally buried to a depth of 0.9 metres to the protective covers but this depth can vary depending on location (bridges may have cables 100mm below surface level)..The specific cable route record drawings show further details along the route of the particular cable. The cable route drawings are attached to this letter for your information.
- Cables installed in cable tunnels, whilst less likely to be affected by surface or shallow works may be affected by activities such as piling.
- National Grid assets can be adversely affected by vibration and can provide guidance on the acceptable levels of vibration due to piling and other construction related operations in the vicinity of national grid assets
- Ground cover above our cables should not be reduced or increased without consultation with National Grid.

- If a landscaping scheme is proposed as part of the works, we request that no trees and shrubs are planted either directly above or within 3 metres of the existing underground cable, as ultimately the roots may grow to cause damage to the cable.

## **Cables Tunnels**

- National Grid's underground cable tunnels are protected by the provisions of a Wayleave/Easement or the New Roads and Street Works Act. This provides full right of access to retain, maintain, repair and inspect our asset.
- Further information and guidance regarding National Grid Cable Tunnels is available on our website at <https://www.nationalgrid.com/uk/electricity-transmission/document/121061/download>
- National Grid requires that the clearances indicated in the guidance document linked above are maintained at all times. Should it be necessary to enter the exclusion zone discussion/ agreement with National Grid is required to ensure the integrity of their tunnel asset and the high voltage cables is not compromised.
- Ground levels above our cable tunnels must not be altered in any way without prior agreement with National Grid; any alterations to the depth of our tunnels can compromise its integrity which could have an adverse impact on the reliability, efficiency and safety of our electricity network.
- Any works which would create high levels of vibration such as piling would need to be assessed by National Grid to ensure it has limited impact on our cable tunnels. National Grid can advise on acceptable vibration limits.

## **Overhead Lines**

- National Grid's Overhead Line/s is protected by a Deed of Easement/Wayleave Agreement which provides full right of access to retain, maintain, repair and inspect our asset.
- The submitted proposed design does not change after the date of this letter. Any design change that moves the proposal closer to National Grid Overhead Line Assets shall be submitted for assessment.
- Statutory electrical safety clearances shall be maintained at all times. National Grid recommends that no permanent structures are built directly beneath our overhead lines. These distances are set out in EN 43 – 8 Technical Specification for "Overhead Line Clearances Issue 5 (2019). To purchase & download EN 43 – 8 Technical Specification for "Overhead Line Clearances Issue 5 (2019) go to <https://www.ena-eng.org/ENA-Docs/>
- Any changes in ground levels which are proposed either beneath or in close proximity to our existing overhead lines would serve to reduce safety clearances. Safety clearances to existing overhead lines must be maintained in all circumstances.
- To view the Development Near Overhead Lines Document.  
<https://www.nationalgridet.com/document/130626/download>
- To view the National Grid Third Party Guidance for working near National Grid Electricity Transmission equipment.  
<https://www.nationalgridet.com/sites/et/files/documents/Working%20near%20electricity%20equipment.pdf>
- The relevant guidance in relation to working safely near to existing overhead lines is contained within the Health and Safety Executive's ([www.hse.gov.uk](http://www.hse.gov.uk)) Guidance Note GS 6 "Avoidance of Danger from Overhead Electric Lines."

- If a landscaping scheme is proposed as part of the proposal, only slow and low growing species of trees and shrubs shall be planted beneath and adjacent to the existing overhead line to reduce the risk of growth to a height which compromises statutory safety clearances.
- Drilling or excavation works shall not be undertaken if they have the potential to disturb or adversely affect the foundations or “pillars of support” of our towers. These foundations extend beyond the base of the tower. Pillar of Support drawings shall be obtained using the contact details above.
- Due to the scale, bulk and cost of the transmission equipment required to operate at 275kV or 400kV we only support proposals for the relocation of existing high voltage overhead lines where such proposals directly facilitate a major development or infrastructure project of national importance which has been identified as such by government.
- To promote the successful development of sites crossed by existing overhead lines, and the creation of well-designed places, National Grid has produced ‘Design guidelines for development near pylons and high voltage overhead power lines’, which look at how to create high quality development near overhead lines and offer practical solutions which can assist in avoiding the unnecessary sterilisation of land in the vicinity of high voltage overhead lines.
- Further information regarding our undergrounding policy and development near transmission overhead lines is available on our website at: <https://www.nationalgridet.com/network-and-assets/planning-and-development>

# Overview map of worksite

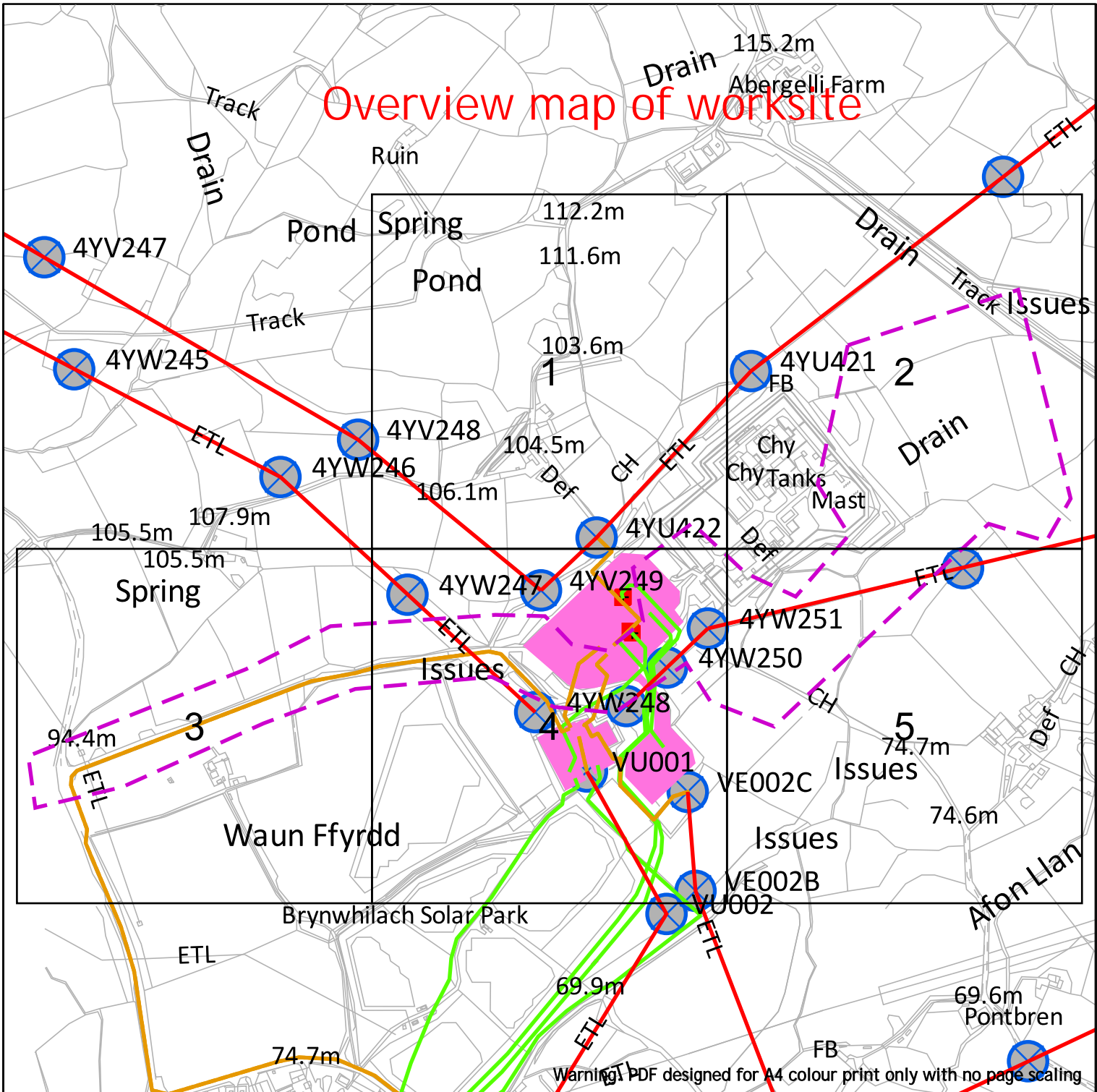

**nationalgrid**

**EXTREME CAUTION - HIGH VOLTAGE  
\*\*RISK OF DEATH OR SERIOUS INJURY\*\***

**NationalGrid House**  
Warwick Technology Park  
Gallows Hill  
Warwick  
CV34 6DA  
  
AssetProtection@NationalGrid.com

Date Requested: 05/12/2022  
Job Reference: 27820377  
Site Location: 265236 200946  
Requested by: Mr Ben Evans  
  
Your Scheme/Reference: LM  
115410/DK

Scale: 1:7688 (When plotted at A4)

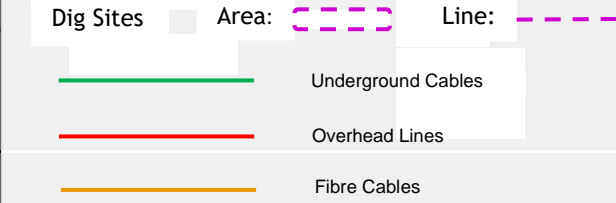

**IMPORTANT NOTICES**

This plan shows those pipes owned by National Grid Electricity Transmission plc in its role as a Licensed Electricity Transporter (ET). Electricity cables owned by other ETs, or otherwise privately owned, may be present in this area. Information with regards to such cables should be obtained from the relevant owners. The information shown on this plan is given without warranty, the accuracy thereof cannot be guaranteed. Ancillary equipment such as cooling systems and communication cables are not shown but their presence should be anticipated. No liability of any kind whatsoever is accepted by National Grid Electricity Transmission plc or their agents, servants or contractors for any error or omission. Safe digging practices, in accordance with HS(G)47, must be used to verify and establish the actual position of cables and other apparatus on site before any mechanical plant is used. It is your responsibility to ensure that this information is provided to all persons (either direct labour or contractors) working for you on or near electricity apparatus. The information included on this plan should not be referred to beyond a period of 28 days from the date of issue.

**National Grid Electricity Emergency Number: 0800 40 40 90**  
Available 24 hours, 7 days/week. Calls may be recorded and monitored



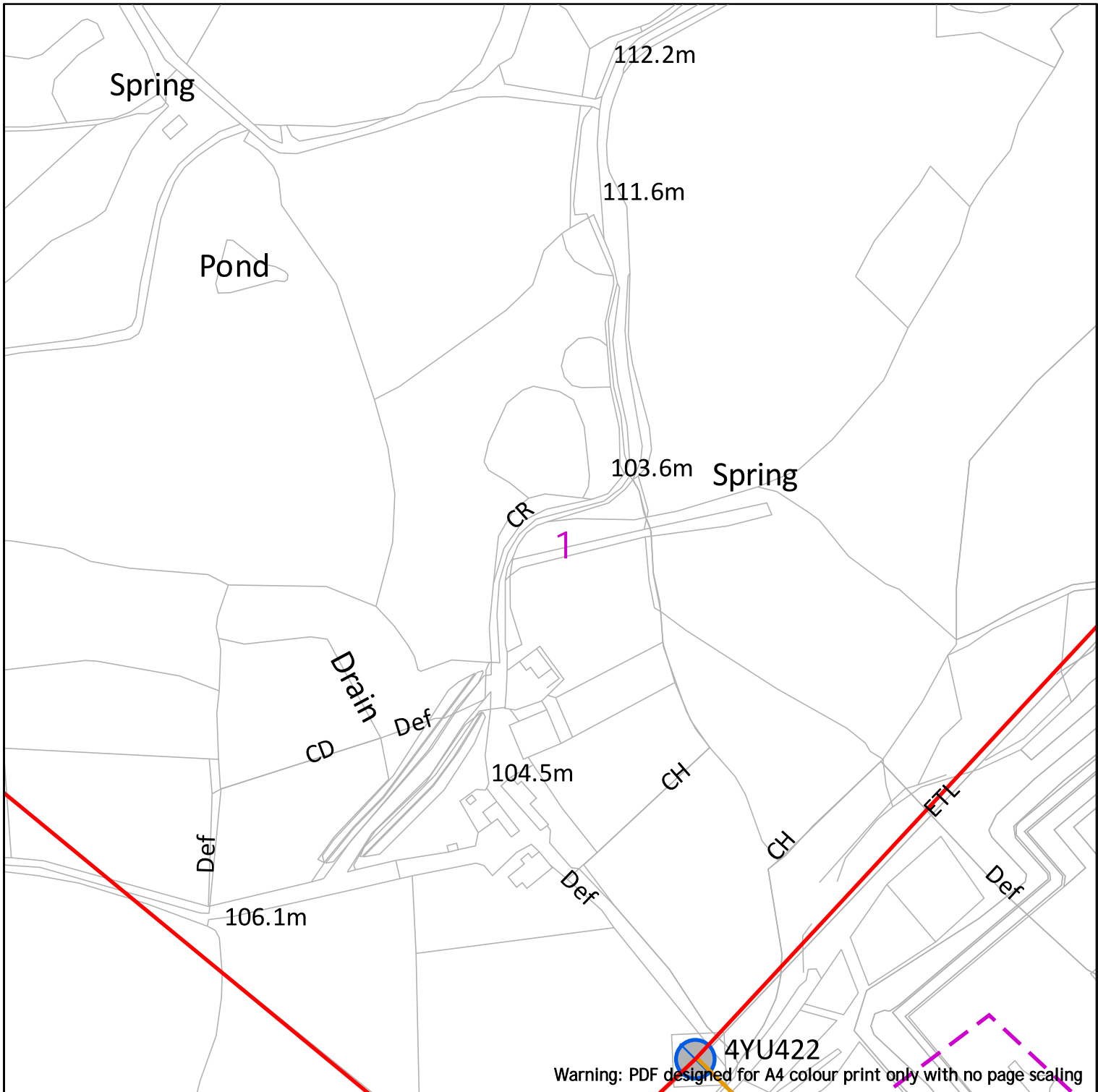

**nationalgrid**

**NationalGrid House**  
 Warwick Technology Park  
 Gallows Hill  
 Warwick  
 CV34 6DA

AssetProtection@NationalGrid.com

Date Requested: 05/12/2022  
 Job Reference: 27820377  
 Site Location: 265236 200946  
 Requested by: Mr Ben Evans

Your Scheme/Reference: LM  
 115410/DK

Scale: 1:2500 (When plotted at A4)



**EXTREME CAUTION - HIGH VOLTAGE**  
**\*\*RISK OF DEATH OR SERIOUS INJURY\*\***

- Dig Sites
- Area:
- Line:
- Underground Cables
- Overhead Lines
- Fibre Cables

**IMPORTANT NOTICES**

This plan shows those pipes owned by National Grid Electricity Transmission plc in its role as a Licensed Electricity Transporter (ET). Electricity cables owned by other ETs, or otherwise privately owned, may be present in this area. Information with regards to such cables should be obtained from the relevant owners. The information shown on this plan is given without warranty, the accuracy thereof cannot be guaranteed. Ancillary equipment such as cooling systems and communication cables are not shown but their presence should be anticipated. No liability of any kind whatsoever is accepted by National Grid Electricity Transmission plc or their agents, servants or contractors for any error or omission. Safe digging practices, in accordance with HS(G)47, must be used to verify and establish the actual position of cables and other apparatus on site before any mechanical plant is used. It is your responsibility to ensure that this information is provided to all persons (either direct labour or contractors) working for you on or near electricity apparatus. The information included on this plan should not be referred to beyond a period of 28 days from the date of issue.

**National Grid Electricity Emergency Number: 0800 40 40 90**

Available 24 hours, 7 days/week. Calls may be recorded and monitored

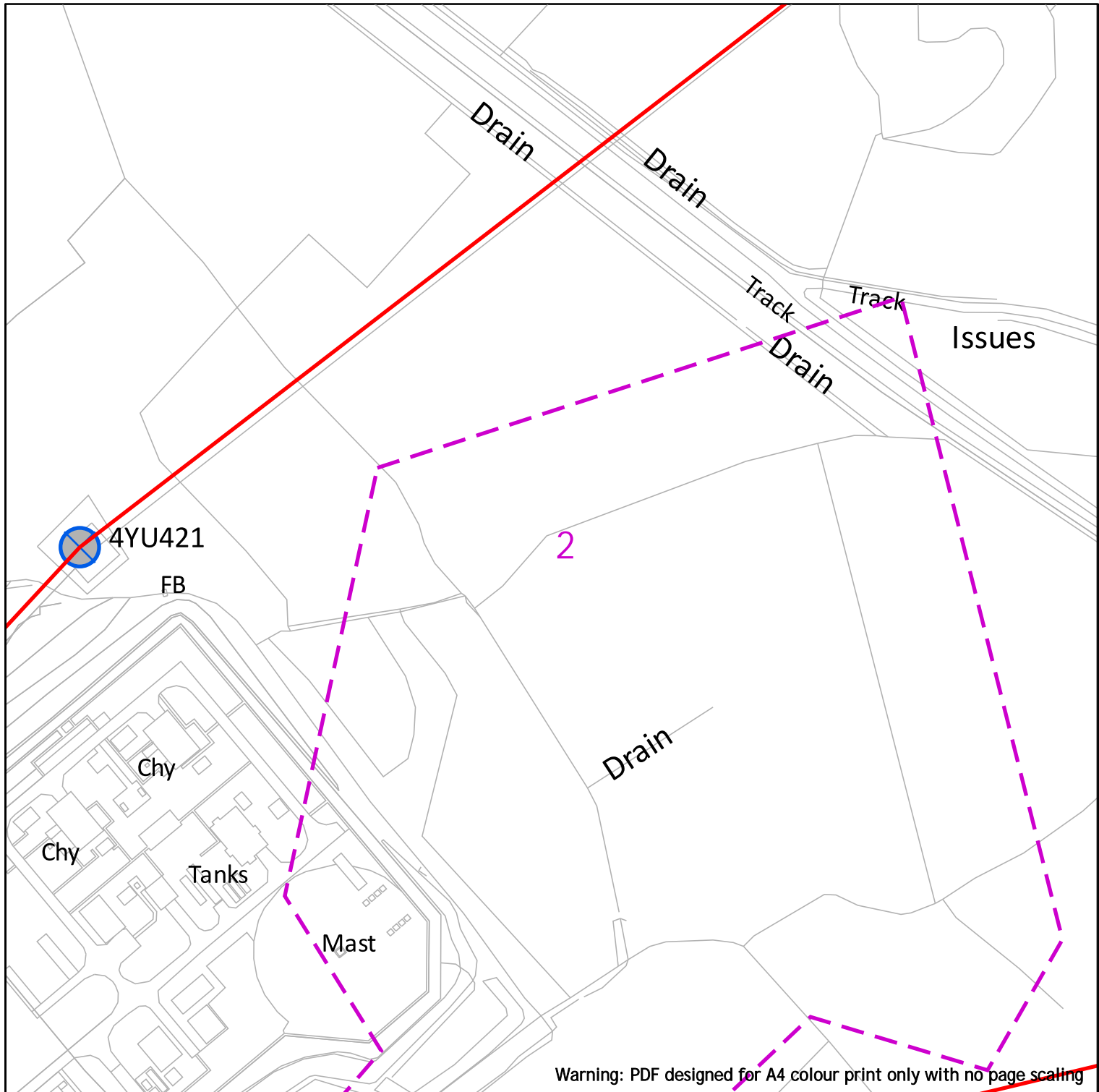

Warning: PDF designed for A4 colour print only with no page scaling

**nationalgrid**



**EXTREME CAUTION - HIGH VOLTAGE  
\*\*RISK OF DEATH OR SERIOUS INJURY\*\***

Dig Sites	Area:	Line:
	Underground Cables	
	Overhead Lines	
	Fibre Cables	

**NationalGrid House**  
Warwick Technology Park  
Gallows Hill  
Warwick  
CV34 6DA  
  
AssetProtection@NationalGrid.com

Date Requested: 05/12/2022  
Job Reference: 27820377  
Site Location: 265236 200946  
Requested by: Mr Ben Evans  
  
Your Scheme/Reference: LM  
115410/DK

**IMPORTANT NOTICES**

This plan shows those pipes owned by National Grid Electricity Transmission plc in its role as a Licensed Electricity Transporter (ET). Electricity cables owned by other ETs, or otherwise privately owned, may be present in this area. Information with regards to such cables should be obtained from the relevant owners. The information shown on this plan is given without warranty, the accuracy thereof cannot be guaranteed. Ancillary equipment such as cooling systems and communication cables are not shown but their presence should be anticipated. No liability of any kind whatsoever is accepted by National Grid Electricity Transmission plc or their agents, servants or contractors for any error or omission. Safe digging practices, in accordance with HS(G)47, must be used to verify and establish the actual position of cables and other apparatus on site before any mechanical plant is used. It is your responsibility to ensure that this information is provided to all persons (either direct labour or contractors) working for you on or near electricity apparatus. The information included on this plan should not be referred to beyond a period of 28 days from the date of issue.

**National Grid Electricity Emergency Number: 0800 40 40 90**  
Available 24 hours, 7 days/week. Calls may be recorded and monitored

Scale: 1:2500 (When plotted at A4)

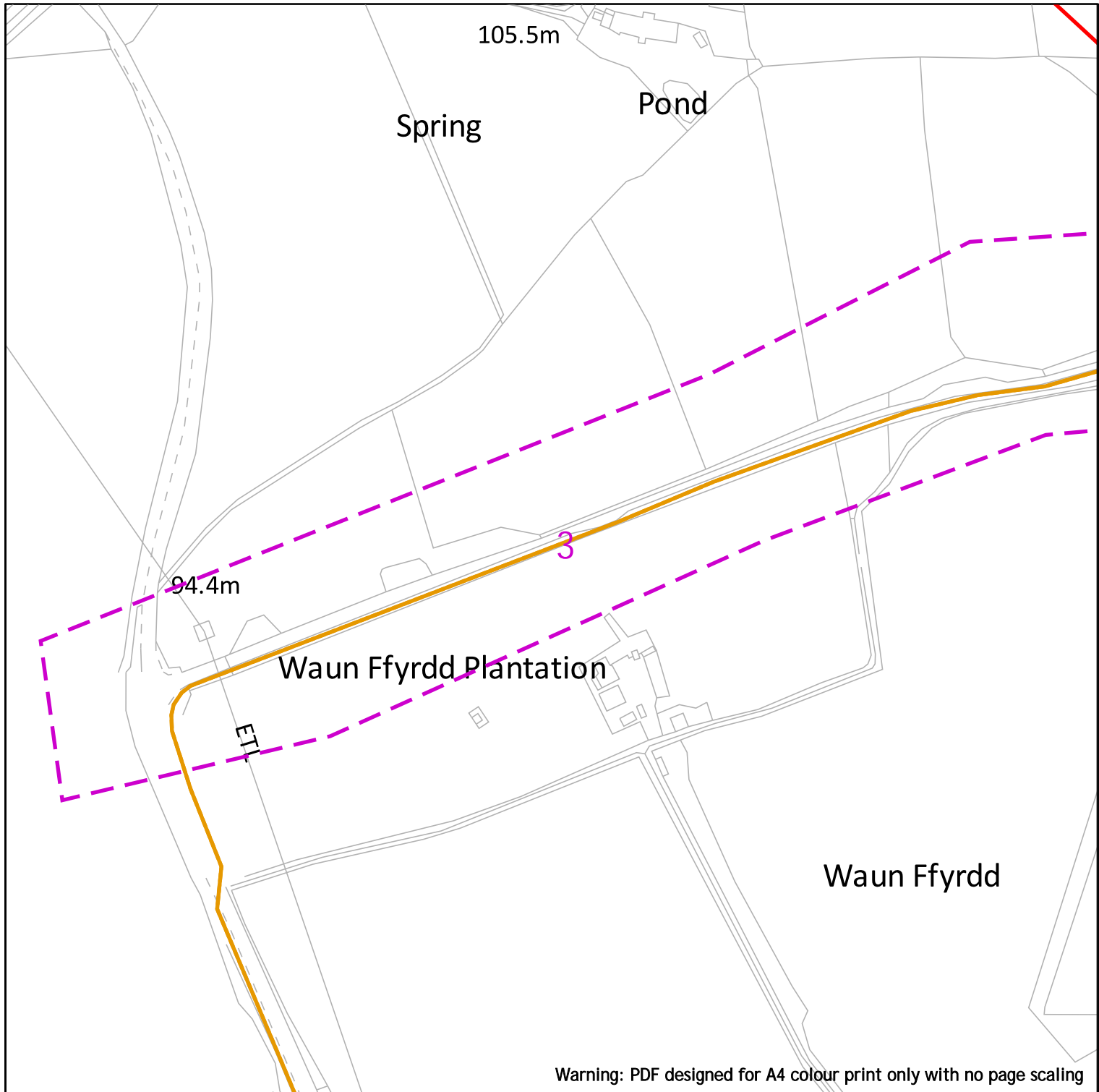

Warning: PDF designed for A4 colour print only with no page scaling

**nationalgrid**



**EXTREME CAUTION - HIGH VOLTAGE  
\*\*RISK OF DEATH OR SERIOUS INJURY\*\***

Dig Sites	Area:	Line:
	Underground Cables	
	Overhead Lines	
	Fibre Cables	

**NationalGrid House**  
 Warwick Technology Park  
 Gallows Hill  
 Warwick  
 CV34 6DA  
 AssetProtection@NationalGrid.com

Date Requested: 05/12/2022  
 Job Reference: 27820377  
 Site Location: 265236 200946  
 Requested by: Mr Ben Evans  
 Your Scheme/Reference: LM  
 115410/DK

**IMPORTANT NOTICES**  
 This plan shows those pipes owned by National Grid Electricity Transmission plc in its role as a Licensed Electricity Transporter (ET). Electricity cables owned by other ETs, or otherwise privately owned, may be present in this area. Information with regards to such cables should be obtained from the relevant owners. The information shown on this plan is given without warranty, the accuracy thereof cannot be guaranteed. Ancillary equipment such as cooling systems and communication cables are not shown but their presence should be anticipated. No liability of any kind whatsoever is accepted by National Grid Electricity Transmission plc or their agents, servants or contractors for any error or omission. Safe digging practices, in accordance with HS(G)47, must be used to verify and establish the actual position of cables and other apparatus on site before any mechanical plant is used. It is your responsibility to ensure that this information is provided to all persons (either direct labour or contractors) working for you on or near electricity apparatus. The information included on this plan should not be referred to beyond a period of 28 days from the date of issue.

**National Grid Electricity Emergency Number: 0800 40 40 90**  
 Available 24 hours, 7 days/week. Calls may be recorded and monitored

Scale: 1:2500 (When plotted at A4)

Crown Copyright © - Reproduced by permission of Ordnance Survey on behalf of HMSO. And database right 2018. All rights reserved. Ordnance Survey Licence number 0100059731.

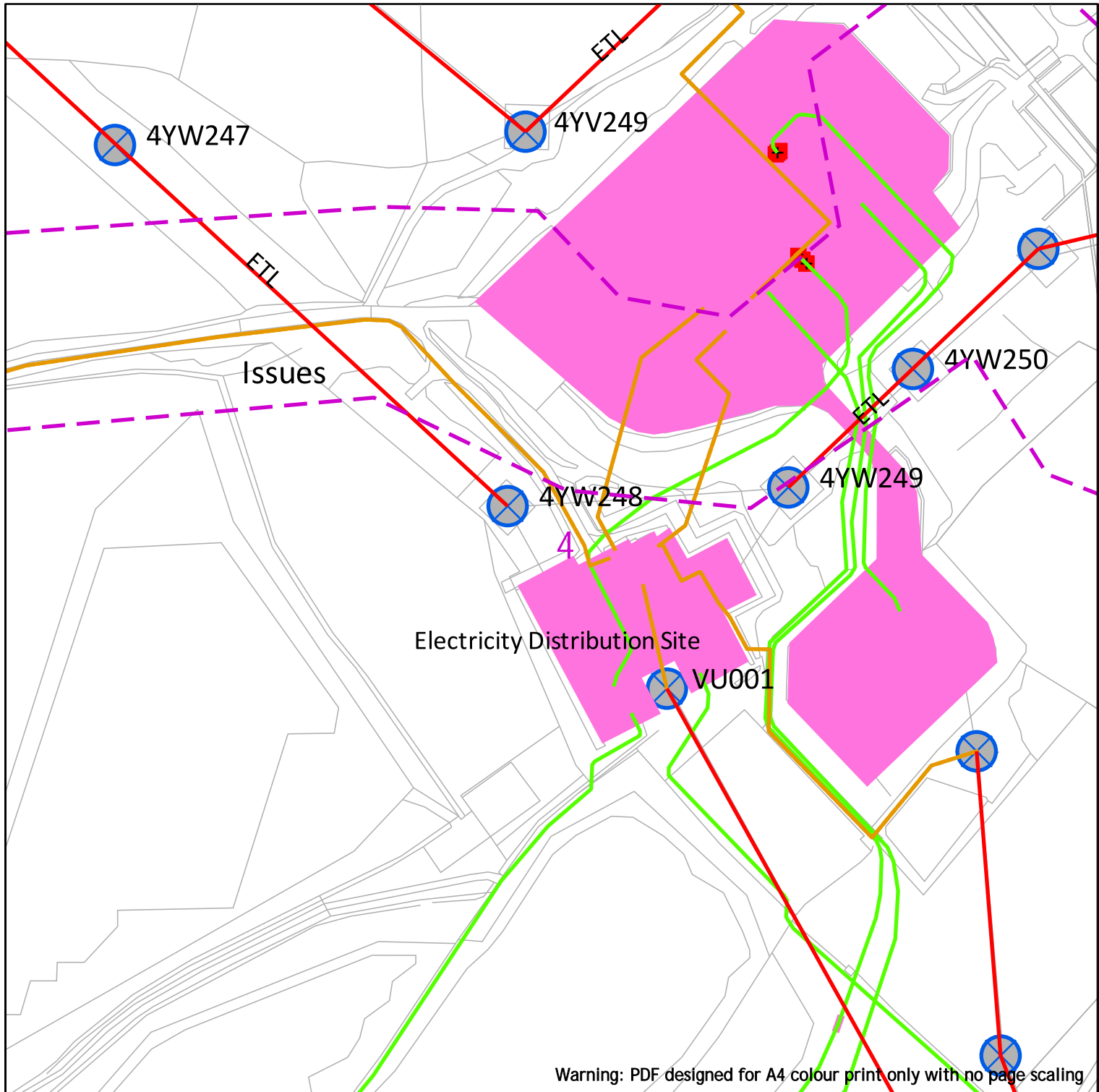

**nationalgrid**



**EXTREME CAUTION - HIGH VOLTAGE  
\*\*RISK OF DEATH OR SERIOUS INJURY\*\***

Dig Sites	Area:	Line:
	Underground Cables	
	Overhead Lines	
	Fibre Cables	

**NationalGrid House**  
Warwick Technology Park  
Gallows Hill  
Warwick  
CV34 6DA  
  
AssetProtection@NationalGrid.com

Date Requested: 05/12/2022  
Job Reference: 27820377  
Site Location: 265236 200946  
Requested by: Mr Ben Evans  
  
Your Scheme/Reference: LM  
115410/DK

**IMPORTANT NOTICES**

This plan shows those pipes owned by National Grid Electricity Transmission plc in its role as a Licensed Electricity Transporter (ET). Electricity cables owned by other ETs, or otherwise privately owned, may be present in this area. Information with regards to such cables should be obtained from the relevant owners. The information shown on this plan is given without warranty, the accuracy thereof cannot be guaranteed. Ancillary equipment such as cooling systems and communication cables are not shown but their presence should be anticipated. No liability of any kind whatsoever is accepted by National Grid Electricity Transmission plc or their agents, servants or contractors for any error or omission. Safe digging practices, in accordance with HS(G)47, must be used to verify and establish the actual position of cables and other apparatus on site before any mechanical plant is used. It is your responsibility to ensure that this information is provided to all persons (either direct labour or contractors) working for you on or near electricity apparatus. The information included on this plan should not be referred to beyond a period of 28 days from the date of issue.

**National Grid Electricity Emergency Number: 0800 40 40 90**  
Available 24 hours, 7 days/week. Calls may be recorded and monitored

Scale: 1:2500 (When plotted at A4)

Crown Copyright © - Reproduced by permission of Ordnance Survey on behalf of HMSO. And database right 2018. All rights reserved. Ordnance Survey Licence number 0100059731.

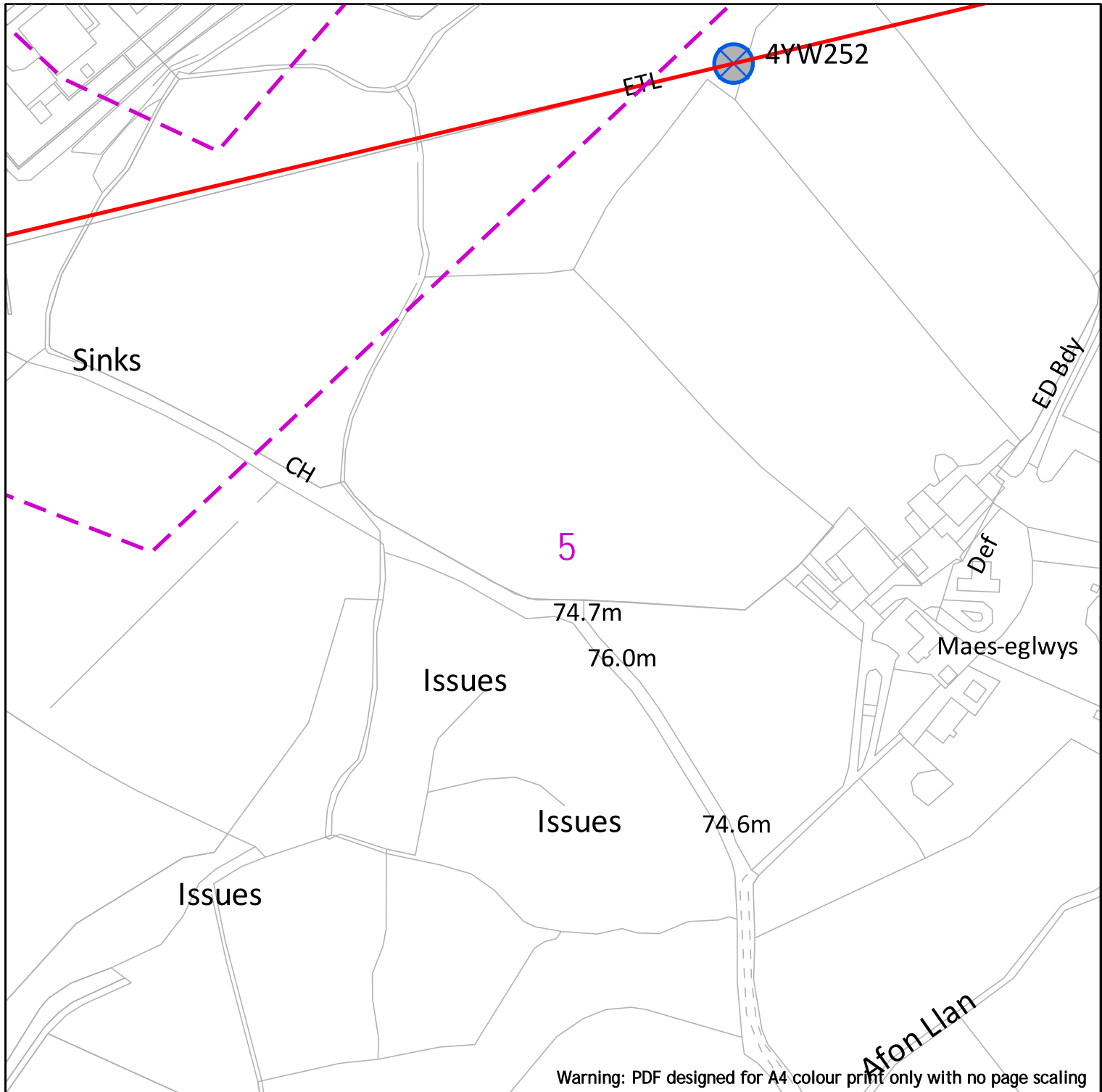

Warning: PDF designed for A4 colour print only with no page scaling

**nationalgrid**



**EXTREME CAUTION - HIGH VOLTAGE  
\*\*RISK OF DEATH OR SERIOUS INJURY\*\***

- Dig Sites
- Area:
- Line:
- Underground Cables
- Overhead Lines
- Fibre Cables

**NationalGrid House**  
 Warwick Technology Park  
 Gallows Hill  
 Warwick  
 CV34 6DA  
 AssetProtection@NationalGrid.com

Date Requested: 05/12/2022  
 Job Reference: 27820377  
 Site Location: 265236 200946  
 Requested by: Mr Ben Evans  
 Your Scheme/Reference: LM  
 115410/DK

**IMPORTANT NOTICES**

This plan shows those pipes owned by National Grid Electricity Transmission plc in its role as a Licensed Electricity Transporter (ET). Electricity cables owned by other ETs, or otherwise privately owned, may be present in this area. Information with regards to such cables should be obtained from the relevant owners. The information shown on this plan is given without warranty, the accuracy thereof cannot be guaranteed. Ancillary equipment such as cooling systems and communication cables are not shown but their presence should be anticipated. No liability of any kind whatsoever is accepted by National Grid Electricity Transmission plc or their agents, servants or contractors for any error or omission. Safe digging practices, in accordance with HS(G)47, must be used to verify and establish the actual position of cables and other apparatus on site before any mechanical plant is used. It is your responsibility to ensure that this information is provided to all persons (either direct labour or contractors) working for you on or near electricity apparatus. The information included on this plan should not be referred to beyond a period of 28 days from the date of issue.

**National Grid Electricity Emergency Number: 0800 40 40 90**

Available 24 hours, 7 days/week. Calls may be recorded and monitored

Scale: 1:2500 (When plotted at A4)

# ENQUIRY SUMMARY

## Received Date

05/12/2022 8:17

## Work Start Date

06/12/2022

## Your Reference

LM 115410/DK

## Location

Centre Point: 265236 200946

X Extent:

Y Extent:

Postcode: SA5 7LU

## Map Options

Paper Size: A4

Orientation: PORTRAIT

Scale: 1:2500

Real World Extents: 1466m x 728m

## Enquirer Details

Organisation Name: Atkins - Utility Solutions

Contact Name: Ben Evans

Email Address: searches.utilitysolutions@atkinglobal.com

Telephone: 01454662086

Address: The Hub, 500 Park Avenue, Aztec West, , Bristol, BS32 4RZ

## Enquiry Type

Initial Enquiry

## Activity Type

Utility Works

## Work Types

Single excavations site (deeper than 1.5m)

## Notes/Works Description (if supplied)

## Site Contact Name (if supplied)

## Site Contact Number (if supplied)

**THIS DOCUMENT IS FOR VIEWING PURPOSES ONLY - NOT TO BE TREATED AS THE MASTER  
ELECTRICITY ALLIANCE-NATIONAL GRID**

**UNDERGROUND CABLE RECORDS**

**LOCATION :** SWANSEA NORTH: G.I.S. SUBSTATION (SGT5) TO O.H.L.TOWER  
**CIRCUITS :** 132kV SGT5 CIRCUIT

PRYSMIAN CONTRACT No. 1SWN-0004  
 ALLIANCE CONTRACT No. 50050573/N06/F11  
 NATIONAL GRID PROJECT REF. IR11512

CABLES INSTALLED: 132kV, 1000mm<sup>2</sup> SINGLE CORE Cu, XLPE, Cu WIRE SCREEN, LEAD ALLOY SHEATH, Pe, CABLES

INSTALLED: JAN 2011 & MAY 2012

PRESSURE TEST DATE: 9 JUNE 2012

ALLIANCE PROJECT MANAGER

Mr P. HAMNET

ALLIANCE ENGINEER

Mr C. McMAHON

CONTENTS

PAGE	DESCRIPTION
1	TITLE & CONTENTS SHEET (THIS SHEET)
2	KEY PLAN (1/1250)
3 & 4	CABLE ROUTE PLANS (1/250)
5	TRENCH CROSS SECTIONS
6	ARRANGEMENT OF TERMINATIONS: ODSEs AT 400kV SUBST'N
7	ARRANGEMENT OF TERMINATIONS: ODSEs AT G.I.S. SUBST'N (ADJ SGT5)
8	CABLE & JOINTING SCHEDULE + BONDING DIAGRAM
9	CABLE CROSS SECTION & DETAILS

CONTRACTORS

PRYSMIAN CABLES & SYSTEMS

PRYSMIAN SITE ENGINEER

Mr M BROWN, Mr B WANKLING

PRYSMIAN CONTRACT MANAGER

Mr W. MILLS



DRAUGHTSMAN

Mr S PERRY

SUB CONTRACTORS (CIVILS)

NEARY CONSTRUCTION

Electricity Alliance	
<small>South West Alliance, Ashville Industrial Estate, Short Way, Thornbury, South Gloucestershire, BS35 3UT</small>	
<b>nationalgrid</b>	
<small>Warwick Technology Park, Gallow's Hill, Warwick, CV34 6DA</small>	
Originator Reference No.   1SWN0004-BM-003	BHT: 1 OF 9
Drg No.	
<b>70/SWA/0640002</b>	
N.G. Scheme No. 11512	

	REV	TITLE	CHK'D	DATE	CABLE RECORDS FOR:	DRAWN	S.P.	DATE	30.05.12	SCALE: N.T.S.	DRAWING SIZE: A2
	A	SEE TITLE BLOCK AND DRG NO 20850 TO THIS PRODUCTION, WORKED AS PART OF SCHEME 11512	PRYSMIAN	13/05/13		CHECKED	B.W.	DATE	15.06.12		
					<b>SWANSEA NORTH 400kV GIS SUBSTATION</b> <b>132kV SGT5 CIRCUIT</b>	NAT GRID PROJECT REF	IR11512			<b>1SWN0004-BM-003 SHT 1</b>	
						PRYSMIAN CONTRACT No.	1SWN-0004				

THIS DOCUMENT IS FOR VIEWING PURPOSES ONLY - NOT TO BE TREATED AS THE MASTER

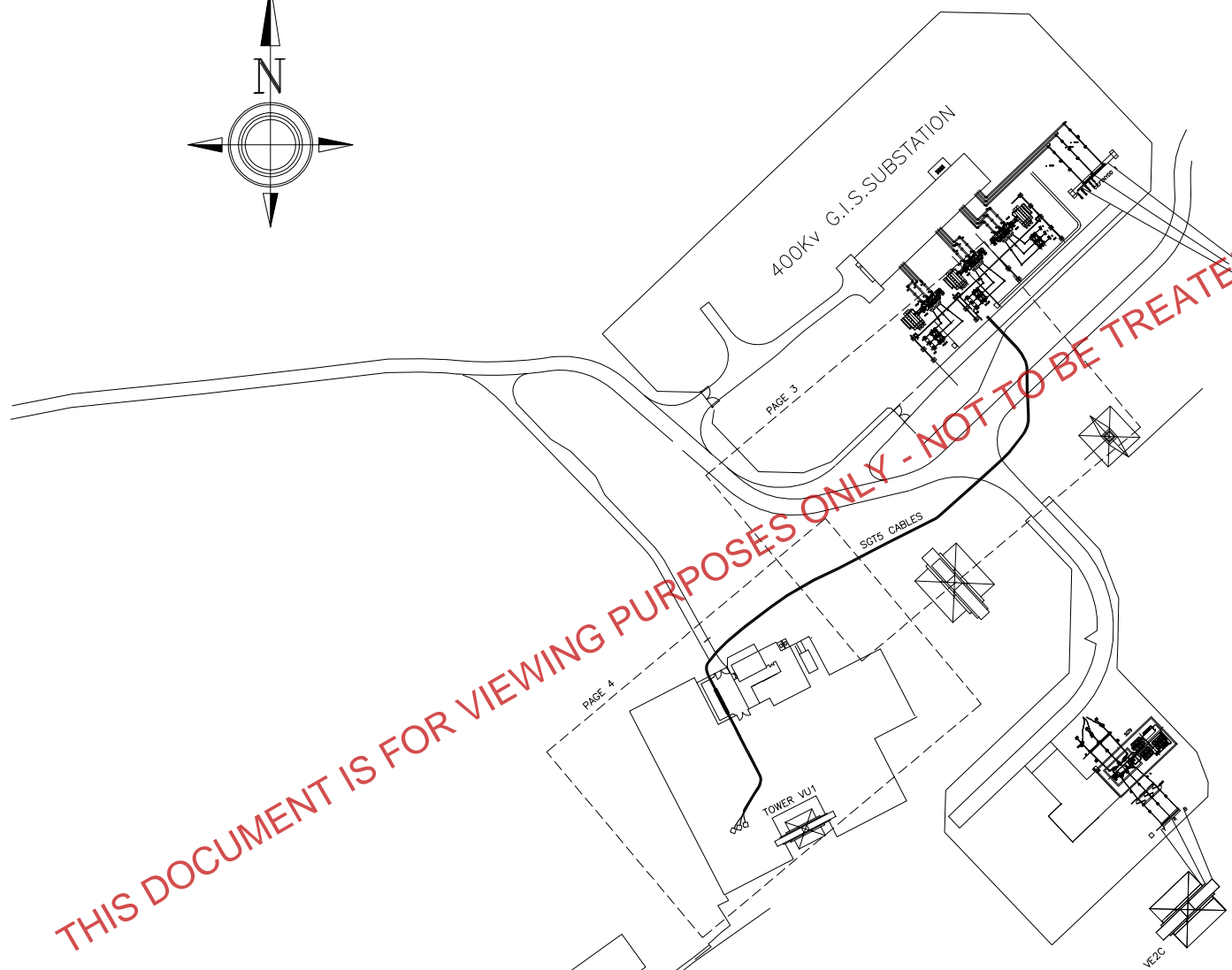
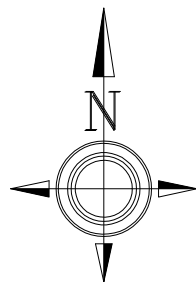

THIS DOCUMENT IS FOR VIEWING PURPOSES ONLY - NOT TO BE TREATED AS THE MASTER

Electricity Alliance  
 South West Alliance, Ashville Industrial Estate, Short Way, Thornbury, South Gloucestershire, BS36 5UT

**nationalgrid**

Warwick Technology Park, Gallows Hill, Warwick, CV34 6BA  
 Originator Reference No. 1 SWN0004-BM-003

DRG No. 70/SWA/0640003

Number 11512

Electricity Alliance

National Grid

REV	TITLE	CHK'D	DATE
A	ISSUE TITLE BLOCK AND DEDICATE TO PWS INSTRUCTIONS. VERIFY AS BUILT. SCHEME 11512	PRYSMIAN	13/05/13
B	FUTURE SGT5 DELETED. VERIFIED AS BUILT. SCHEME 11512	PRYSMIAN	07/06/13

CABLE RECORDS FOR:

**SWANSEA NORTH 400kV GIS SUBSTATION**  
**132kV SGT5 CIRCUIT**

DRAWN	S.P.	DATE	30.05.12
CHECKED	B.W.	DATE	15.06.12
CUSTOMER CONTRACT No.	IR11512		
PRYSMIAN CONTRACT No.	1SWN-0004		

SCALE:	1/1250	DRAWING SIZE:	A2
DRG No.	1SWN0004-BM-003 SHT 2		



THIS DOCUMENT IS FOR VIEWING PURPOSES ONLY - NOT TO BE TREATED AS THE MASTER

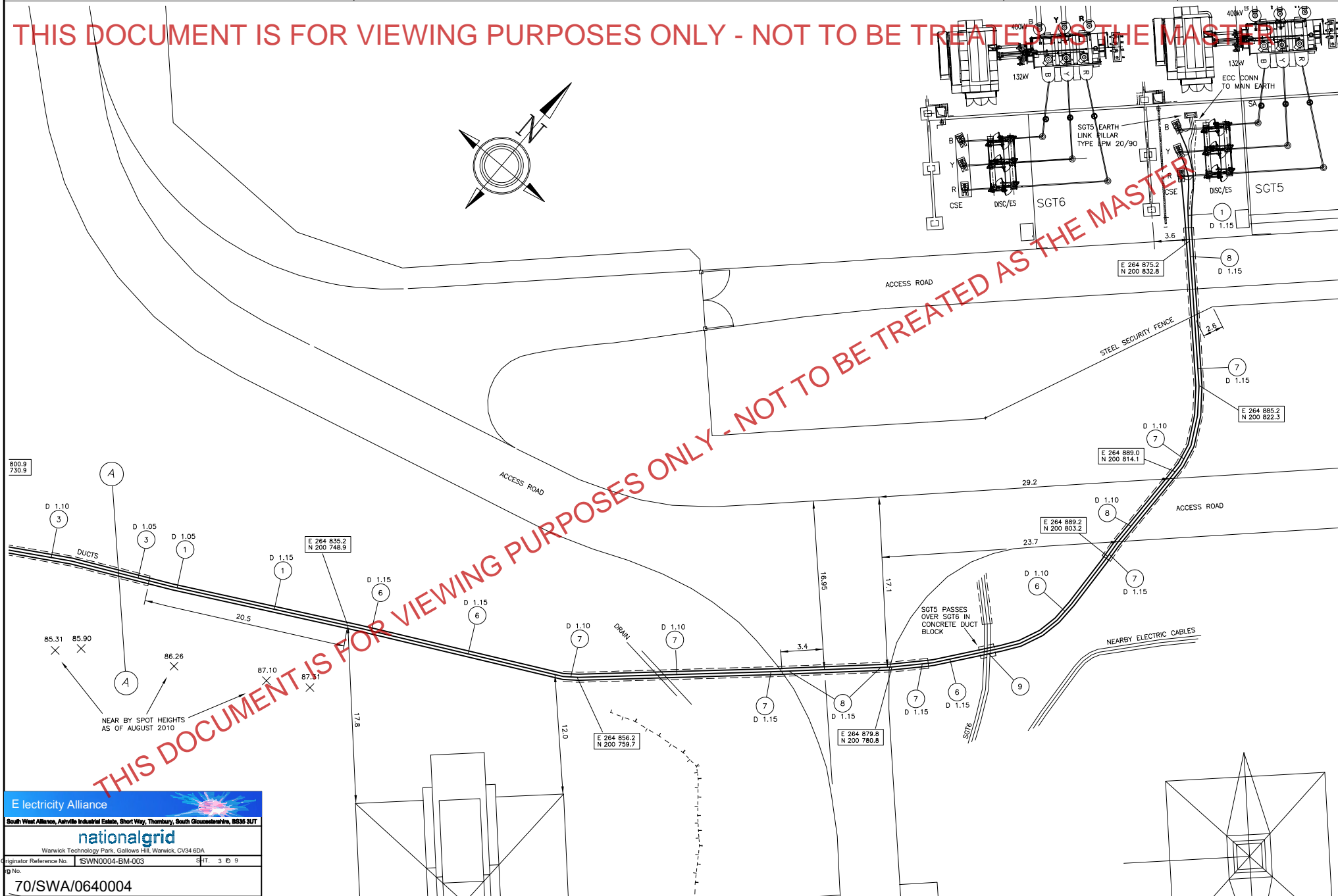
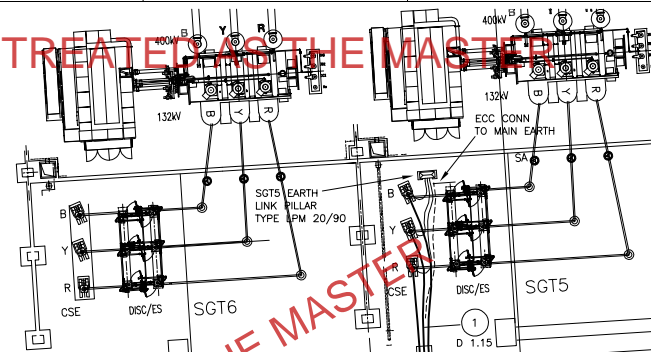
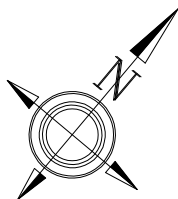

THIS DOCUMENT IS FOR VIEWING PURPOSES ONLY - NOT TO BE TREATED AS THE MASTER

800.9  
730.9

A

D 1.10  
3

D 1.05  
3

D 1.05  
1

D 1.15  
1

E 264 835.2  
N 200 748.9

D 1.15  
6

D 1.15  
6

D 1.10  
7

D 1.10  
7

E 264 856.2  
N 200 759.7

D 1.15  
7

D 1.15  
8

D 1.15  
7

D 1.15  
6

D 1.15  
9

E 264 879.8  
N 200 780.8

E 264 889.2  
N 200 803.2

E 264 889.0  
N 200 814.1

D 1.10  
8

D 1.10  
7

D 1.15  
6

D 1.15  
7

D 1.15  
8

D 1.15  
7

D 1.15  
9

D 1.10  
7

D 1.15  
8

D 1.15  
7

D 1.15  
7

D 1.15  
8

D 1.15  
7

D 1.15  
8

D 1.15  
7

D 1.15  
8

D 1.15  
7

D 1.15  
8

D 1.15  
7

D 1.15  
8

D 1.15  
7

D 1.15  
8

D 1.15  
7

D 1.15  
8

D 1.15  
7

D 1.15  
8

D 1.15  
7

D 1.15  
8

D 1.15  
7

D 1.15  
8

D 1.15  
7

D 1.15  
8

D 1.15  
7

D 1.15  
8

D 1.15  
7

E lectricity Alliance  
 South West Alliance, Ashville Industrial Estate, Short Way, Thornbury, South Gloucestershire, BS35 5UT  
**nationalgrid**  
 Warwick Technology Park, Gallows Hill, Warwick, CV34 6DA  
 Originator Reference No. | SWN0004-BM-003 | SHT. 3 of 9  
 ID No.  
**70/SWA/0640004**  
 Scheffé No. 11512

E lectricity Alliance  
**National Grid**

REV	TITLE	CHK'D	DATE	CABLE RECORDS FOR:
A	SWA TITLE BLOCK AND DRG NO 2000 TO PWS INSTRUCTIONS, VERIFIED AS BUILT, SCHEM 11512	PRYSMAN	13/05/13	

**SWANSEA NORTH 400kV GIS SUBSTATION**  
**132kV SGT5 CIRCUIT**

DRAWN	S.P.	DATE	30.05.12
CHECKED	B.W.	DATE	15.06.12
CUSTOMER CONTRACT No.	IR11512		
PRYSMAN CONTRACT No.	1SWN-0004		

SCALE:	1/250	DRAWING SIZE:	A2
DRG No.	1SWN0004-BM-003 SHT 3		

THIS DOCUMENT IS FOR VIEWING PURPOSES ONLY - NOT TO BE TREATED AS THE MASTER

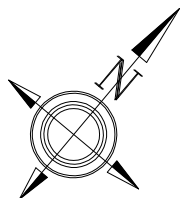

THIS DOCUMENT IS FOR VIEWING PURPOSES ONLY - NOT TO BE TREATED AS THE MASTER



Electricity Alliance  
 South West Alliance, Ashville Industrial Estate, Short Way, Thornbury, South Gloucestershire, BS35 3UT

**nationalgrid**  
 Warwick Technology Park, Gallow's Hill, Warwick, CV34 6DA

Originator Reference No. | 1SWN0004-BM-003 | SHT. 4 OF 9  
 Dwg No.  
**70/SWA/0640005**  
 N.G. Scheme No. 11512

E tectricity Alliance

National Grid

REV	TITLE	CHK'D	DATE
A	SHA TITLE BLOCK AND DRG NO 20050 TO PWS INSTRUCTIONS, VERIFIED AS BUILT - SCHEME 13512	PRYSMIAN	13/05/13

CABLE RECORDS FOR:

**SWANSEA NORTH 400kV GIS SUBSTATION**  
**132kV SGT5 CIRCUIT**

DRAWN	S.P.	DATE	30.05.12
CHECKED	B.W.	DATE	15.06.12
CUSTOMER CONTRACT No.	IR11512		
PRYSMIAN CONTRACT No.	1SWN-0004		

SCALE:	1/250	DRAWING SIZE:	A2
DRG No.	<b>1SWN0004-BM-003 SHT 4</b>		

THIS DOCUMENT IS FOR VIEWING PURPOSES ONLY - NOT TO BE TREATED AS THE MASTER

CABLE SCHEDULE	CIRCUIT	PHASE	SIZE AND DESCRIPTION	FROM	TO	MANUFACTURER	DATE PULLED	LENGTH	DRUM No.	DIRECTION OF PULL	
	SGT5	R		132kV 1000mm <sup>2</sup> SINGLE CORE Cu, XLPE, CuWIRE SCREEN, L.A.S. CABLE	SGT5	O.H.L. TOWER	PRYSMIAN CABLES, WREXHAM	10.1.11	282m	TM 1800364	TOWARDS TOWER- DOWN HILL
		Y		132kV 1000mm <sup>2</sup> SINGLE CORE Cu, XLPE, CuWIRE SCREEN, L.A.S. CABLE	SGT5	O.H.L. TOWER	PRYSMIAN CABLES, WREXHAM	11.1.11	286m	TM 1800282	TOWARDS TOWER- DOWN HILL
		B		132kV 1000mm <sup>2</sup> SINGLE CORE Cu, XLPE, CuWIRE SCREEN, L.A.S. CABLE	SGT5	O.H.L. TOWER	PRYSMIAN CABLES, WREXHAM	12.1.11	291m	TM 1800282	TOWARDS TOWER- DOWN HILL

JOINTING SCHEDULE	CIRCUIT	POSITION OF JOINT	PHASE	TYPE AND DESCRIPTION	JOINT DRG No.	JOINER	DATE JOINED	WEATHER	
	SGT5	S/Es	ADJ TO SGT5	R	132kV XLPE OUTDOOR SEALING END, (CABLES UP TO 1200sq mm)	GA- EL1431S iss5 CORE- 7076721 iss1	D. CRAIG	03.03.11	COLD, DRY
		S/Es	ADJ TO SGT5	Y	132kV XLPE OUTDOOR SEALING END, (CABLES UP TO 1200sq mm)	GA- EL1431S iss5 CORE- 7076721 iss1	D. CRAIG	03.03.11	COLD, DRY
		S/Es	ADJ TO SGT5	B	132kV XLPE OUTDOOR SEALING END, (CABLES UP TO 1200sq mm)	GA- EL1431S iss5 CORE- 7076721 iss1	D. CRAIG	03.03.11	COLD, DRY
		S/Es	ADJ TOWER IN 400kV SUBSTATION	R	132kV XLPE OUTDOOR SEALING END, (CABLES UP TO 1200sq mm)	GA- EL1431S iss5 CORE- 7076721 iss1	A. CHALK	18.05.12	WARM, DRY
		S/Es	ADJ TOWER IN 400kV SUBSTATION	Y	132kV XLPE OUTDOOR SEALING END, (CABLES UP TO 1200sq mm)	GA- EL1431S iss5 CORE- 7076721 iss1	A. CHALK	18.05.12	WARM, DRY
		S/Es	ADJ TOWER IN 400kV SUBSTATION	B	132kV XLPE OUTDOOR SEALING END, (CABLES UP TO 1200sq mm)	GA- EL1431S iss5 CORE- 7076721 iss1	A. CHALK	18.05.12	WARM, DRY

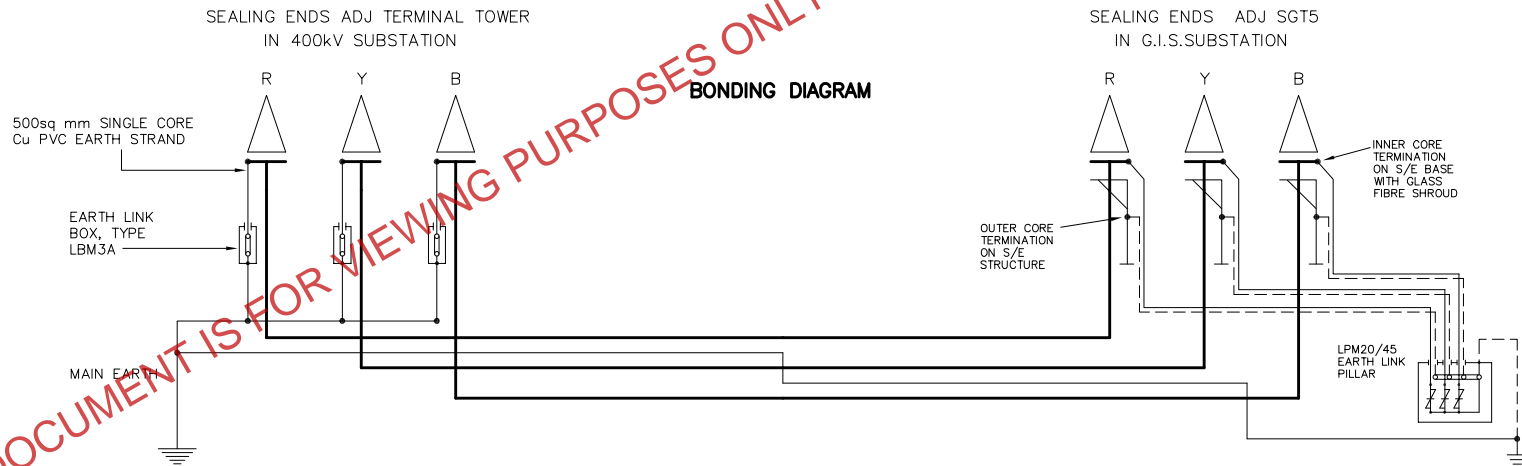

**LEGEND**

EARTH CABLES:  
 — 500sq mm S/C  
 (INNER CORE) — 120sq mm C/C  
 (OUTER CORE) - - - 120sq mm S/C

POWER CABLE: — 1000sq mm S/C



Electricity Alliance	
South West Alliance, Ashville Industrial Estate, Great Way, Thornbury, South Gloucestershire, BS38 5JT	
<b>nationalgrid</b>	
Warwick Technology Park, Gallows Hill, Warwick, CV34 6DA	
Originator Reference No.	1SWN0004-BM-003 SHT 8 OF 9
Dwg No.	70/SWA/0640006
N.G. Scheme No.	11512

E tricity Alliance



National Grid

REV	TITLE	CHK'D	DATE
A	DWG TITLE BLOCK AND DRG NO ADDED TO PWS INSTRUCTION. VERIFIED AS BUILT. SCHEME 11512	PRYSMIAN	13/05/13

CABLE RECORDS FOR:

**SWANSEA NORTH 400kV GIS SUBSTATION  
132kV SGT5 CIRCUIT**

DRAWN	S.P.	DATE
CHECKED	B.W.	DATE
NAT GRID PROJECT REF	IR11512	
PRYSMIAN CONTRACT No.	1SWN-0004	

SCALE: N.T.S.	DRAWING SIZE: A2
DRG No.	1SWN0004-BM-003 SHT 8

# THIS DOCUMENT IS FOR VIEWING PURPOSES ONLY - NOT TO BE TREATED AS THE MASTER ELECTRICITY ALLIANCE-NATIONAL GRID

## UNDERGROUND CABLE RECORDS

**LOCATION :** SWANSEA NORTH: 132kV TO 400kV SUBSTATIONS

**CIRCUITS :** 132kV SGT6 CIRCUIT  
132kV SGT7 CIRCUIT

PRYSMIAN CONTRACT No. 1SWN-0004  
ALLIANCE CONTRACT No. 50050573/N06/F11  
NATIONAL GRID PROJECT REF. IR11512

**CABLES INSTALLED:** 132kV, 1000mm<sup>2</sup> SINGLE CORE Cu, XLPE, Cu WIRE SCREEN, LEAD ALLOY SHEATH, Pe, CABLES

INSTALLED ; MARCH 2010 - APRIL 2012

PRESSURE TEST DATES: SGT6 CIRCUIT - 11 JULY 2011  
SGT7 CIRCUIT - 9 JUNE 2010

ALLIANCE PROJECT MANAGER

Mr P. HAMNET

ALLIANCE ENGINEER

Mr C. McMAHON

CONTENTS

PAGE	DESCRIPTION
1	TITLE & CONTENTS SHEET (THIS SHEET)
2	KEY PLAN (1/2000)
3 TO 11	CABLE ROUTE PLANS (1/250)
12, 13	TRENCH CROSS SECTIONS
14	JOINT BAY 1/2 -SGT6
15	JOINT BAY 1/2 -SGT7
16	ARRANGEMENT OF TERMINATIONS AT SEALING ENDS
17	CABLE & JOINTING SCHEDULE
18	SCHEMATIC BONDING DIAGRAM
19	CABLE CROSS SECTION & DETAILS

CONTRACTORS

PRYSMIAN CABLES & SYSTEMS

PRYSMIAN SITE ENGINEER

Mr M BROWN

PRYSMIAN CONTRACT MANAGER

Mr M. MILLS

DRAUGHTSMAN

Mr S PERRY

SUB CONTRACTORS (CIVILS)

NEARY CONSTRUCTION

Electricity Alliance	
<small>South West Alliance, Ashville Industrial Estate, Short Way, Thornbury, South Gloucestershire, BS35 3UT</small>	
<b>nationalgrid</b>	
<small>Warwick Technology Park, Gallows Hill, Warwick, CV34 6DA</small>	
Originator Reference No.   1SWN0004-BM-001	SHT. 1 OF 19
Drg No.	
<b>70/SWA/0640007</b>	
<small>NG. Scheme No. 11512</small>	

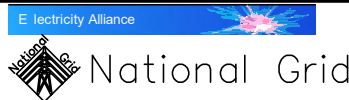

REV	TITLE	CHK'D	DATE
A	SEE TITLE BLOCK AND DRG NO 20050 TO THIS PRODUCTION. WORKED AS PART OF SCHEME 11512	PRYSMIAN	13/05/13

CABLE RECORDS FOR:

**SWANSEA NORTH 132kV - 400kV GIS SUBSTATION  
SGT6 & SGT7 CIRCUITS**

DRAWN	S.P.	DATE	30.6.11
CHECKED	M.M	DATE	4.11.11
NAT GRID PROJECT REF		IR11512	
PRYSMIAN CONTRACT No.		1SWN-0004	
SCALE: N.T.S.		DRAWING SIZE: A2	
DRG No.		<b>1SWN0004-BM-001 SHT 1</b>	

THIS DOCUMENT IS FOR VIEWING PURPOSES ONLY - NOT TO BE TREATED AS THE MASTER



THIS DOCUMENT IS FOR VIEWING PURPOSES ONLY - NOT TO BE TREATED AS THE MASTER

Electricity Alliance  
 South West Alliance, Ashville Industrial Estate, Short Way, Thornbury, South Gloucestershire, BS35 3UT

**nationalgrid**  
 Warwick Technology Park, Gallows Hill, Warwick, CV34 6DA

Originator Reference No. 1SWN0004-BM-001 SHT. 2 OF 19  
 Dwg No.  
**70/SWA/0640008**  
 N.G. Scheme No. 11512

E tricity Alliance

National Grid

REV	TITLE	CHK'D	DATE
A	SWA TITLE BLOCK AND DRG NO ADDED TO PWS INSTRUCTIONS, VERIFIED AS FULLY SCHEM 11512	PRYSMAN	13/05/13

CABLE RECORDS FOR:  
**SWANSEA NORTH 132KV - 400KV GIS SUBSTATION**  
**SGT6 & SGT7 CIRCUITS**

DRAWN	S.P.	DATE	24.6.11
CHECKED	M.M	DATE	4.11.11
NAT GRID PROJECT REF	IR11512		
PRYSMAN CONTRACT No.	1SWN-0004		

SCALE:	1/2000	DRAWING SIZE:	A2
DRG No.	<b>1SWN0004-BM-001 SHT 2</b>		

THIS DOCUMENT IS FOR VIEWING PURPOSES ONLY - NOT TO BE TREATED AS THE MASTER

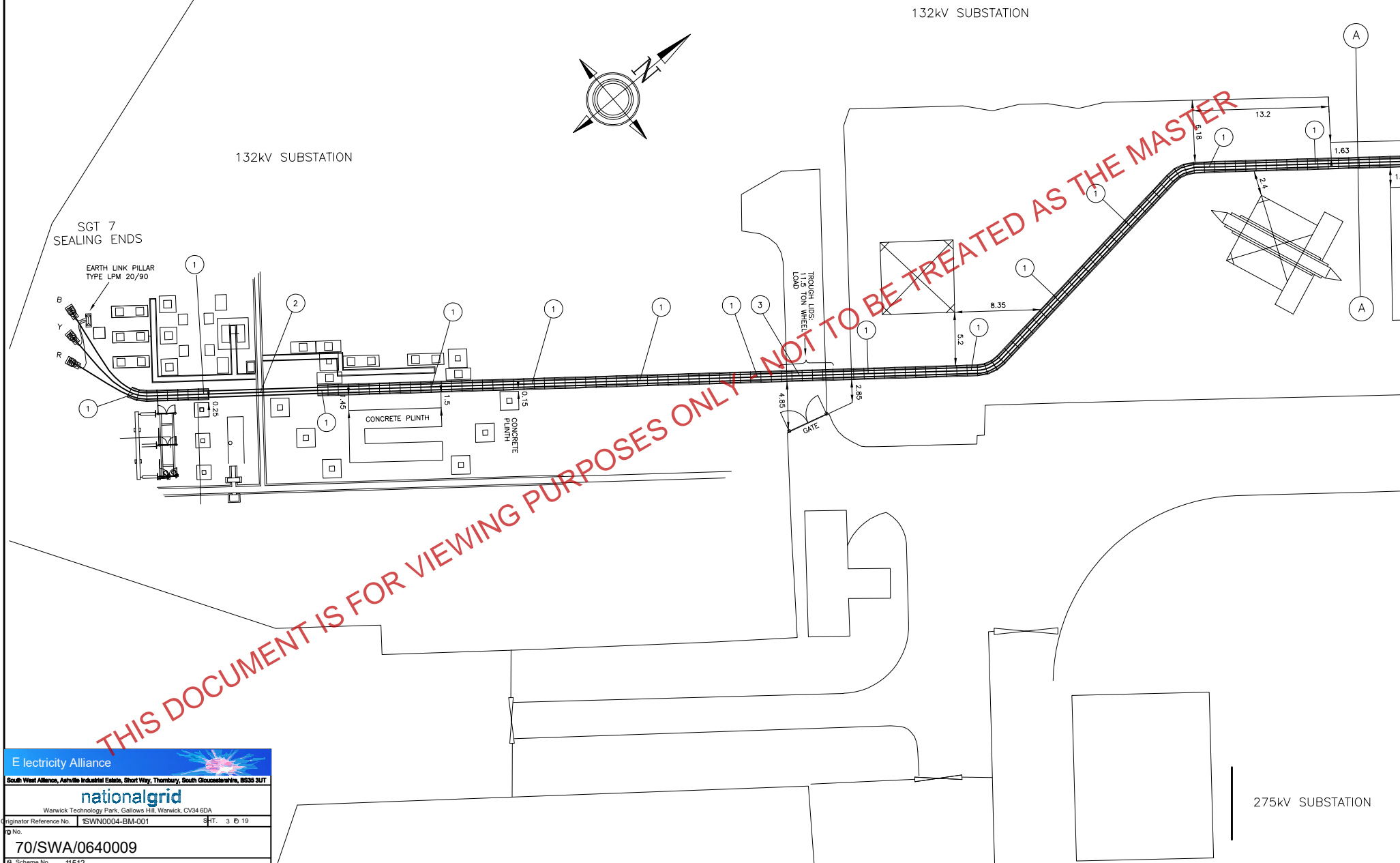

**E lectricity Alliance**  
 South West Alliance, Ashville Industrial Estate, Short Way, Thornbury, South Gloucestershire, BS35 5UT

**nationalgrid**  
 Warwick Technology Park, Gallows Hill, Warwick, CV34 6DA

Originator Reference No. | SWN0004-BM-001 | SHT. 3 of 19  
 ID No.  
**70/SWA/0640009**

Scheme No. 11512

**E lectricity Alliance**

**National Grid**

REV	TITLE	CHK'D	DATE
A	SHA TITLE BLOCK AND DRG NO ADDED TO PWS INSTRUCTIONS, VERIFIED AS BUILT - SCHEME 11512	PRYSMAN	13/05/13

CABLE RECORDS FOR:  
**SWANSEA NORTH 132kV - 400kV GIS SUBSTATION**  
**SGT6 & SGT7 CIRCUITS**

DRAWN	S.P.	DATE
		24.6.11
CHECKED	M.M	DATE
		4.11.11
NAT GRID PROJECT REF	IR11512	
PRYSMAN CONTRACT No.	1SWN-0004	

SCALE: 1/250	DRAWING SIZE: A2
DRG No.	<b>1SWN0004-BM-001 SHT 3</b>

THIS DOCUMENT IS FOR VIEWING PURPOSES ONLY - NOT TO BE TREATED AS THE MASTER

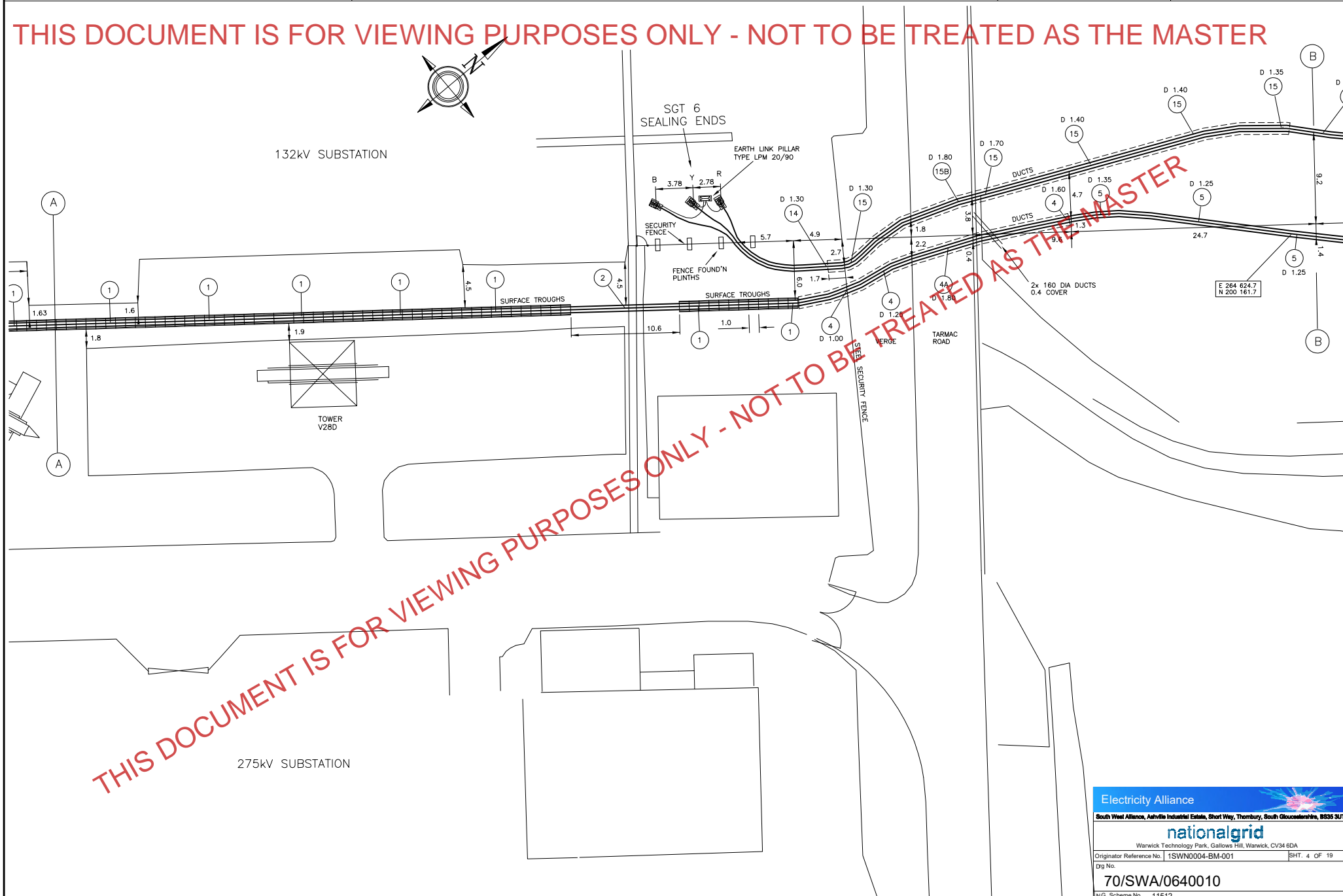

THIS DOCUMENT IS FOR VIEWING PURPOSES ONLY - NOT TO BE TREATED AS THE MASTER

Electricity Alliance  
 South West Alliance, Ashville Industrial Estate, Short Way, Thornbury, South Gloucestershire, BS35 3UT

**nationalgrid**  
 Warwick Technology Park, Gallows Hill, Warwick, CV34 6DA

Originator Reference No. 1SWN0004-BM-001 SHT. 4 OF 19  
 Dwg No. 70/SWA/0640010  
 N.G. Scheme No. 11512

E tectricity Alliance  
 National Grid

REV	TITLE	CHK'D	DATE
A	SHA TITLE BLOCK AND DRG NO ADDED TO PWS INSTRUCTIONS. VERIFIED AS BUILT - SCHEME 11512	PRYSMAN	13/05/13

CABLE RECORDS FOR:  
**SWANSEA NORTH 132kV - 400kV GIS SUBSTATION**  
**SGT6 & SGT7 CIRCUITS**

DRAWN	S.P.	DATE
		24.6.11
CHECKED	M.M.	DATE
		4.11.11
NAT GRID PROJECT REF	IR11512	
PRYSMAN CONTRACT No.	1SWN-0004	

SCALE	1/250	DRAWING SIZE	A2
DRG No.	1SWN0004-BM-001	SHT	4

THIS DOCUMENT IS FOR VIEWING PURPOSES ONLY - NOT TO BE TREATED AS THE MASTER

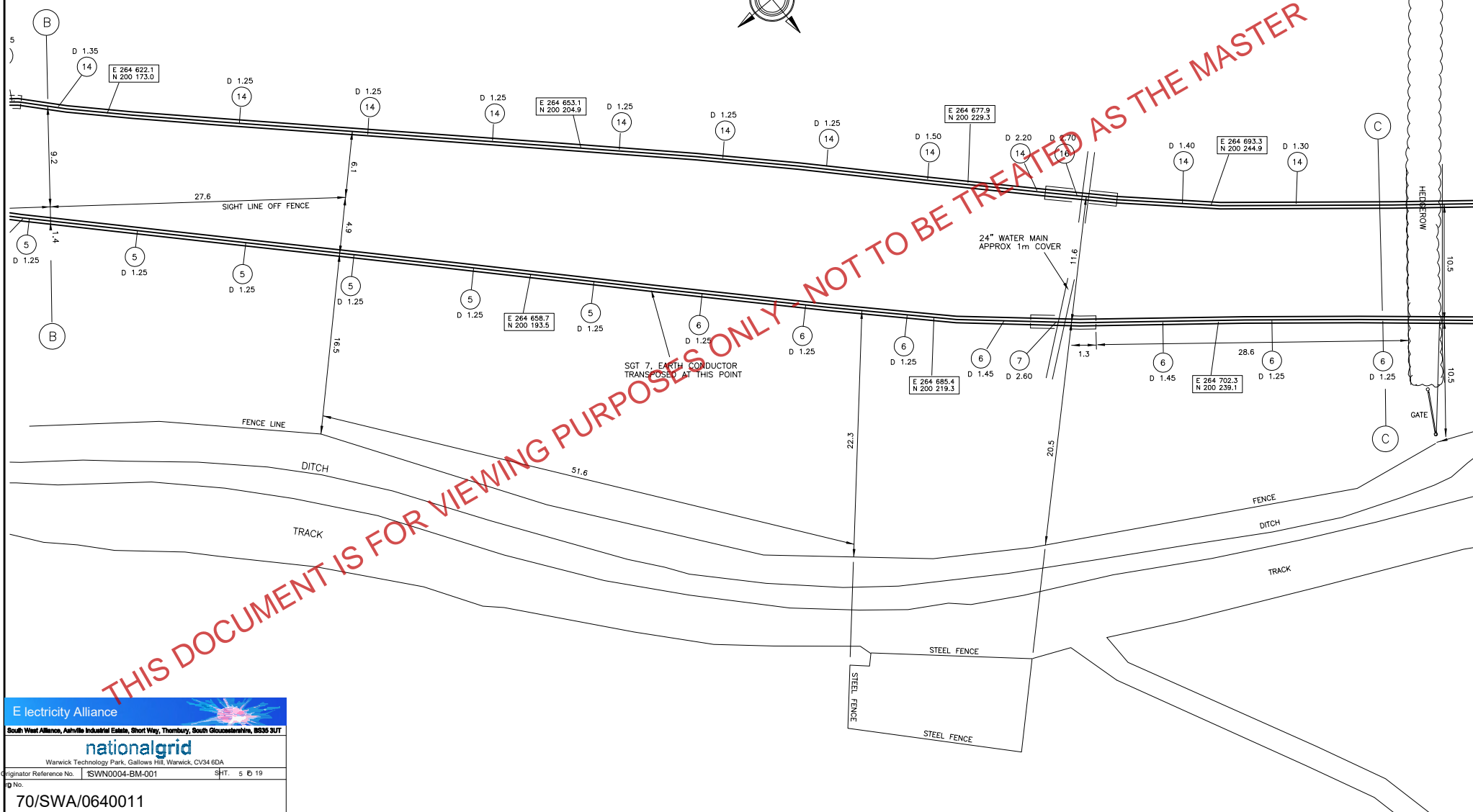

THIS DOCUMENT IS FOR VIEWING PURPOSES ONLY - NOT TO BE TREATED AS THE MASTER

**E lectricity Alliance**  
 South West Alliance, Ashville Industrial Estate, Short Way, Thornbury, South Gloucestershire, BS35 5UT

**nationalgrid**  
 Warwick Technology Park, Gallows Hill, Warwick, CV34 6DA

Originator Reference No. | SWN0004-BM-001 | SHT. 5 of 19

D No.  
**70/SWA/0640011**

Scheme No. 11512

**E lectricity Alliance**

**National Grid**

REV	TITLE	CHK'D	DATE
A	SHA TITLE BLOCK AND DRG NO 20050 TO PWS INSTRUCTIONS. VERIFIED AS BUILT - SCHEME 11512	PRYSMAN	13/05/13

CABLE RECORDS FOR:

**SWANSEA NORTH 132kV - 400kV GIS SUBSTATION**  
**SGT6 & SGT7 CIRCUITS**

DRAWN	S.P.	DATE	24.6.11
CHECKED	M.M	DATE	4.11.11
NAT GRID PROJECT REF	IR11512		
PRYSMAN CONTRACT No.	1SWN-0004		

SCALE: 1/250	DRAWING SIZE: A2
DRG No.	<b>1SWN0004-BM-001 SHT 5</b>



THIS DOCUMENT IS FOR VIEWING PURPOSES ONLY - NOT TO BE TREATED AS THE MASTER

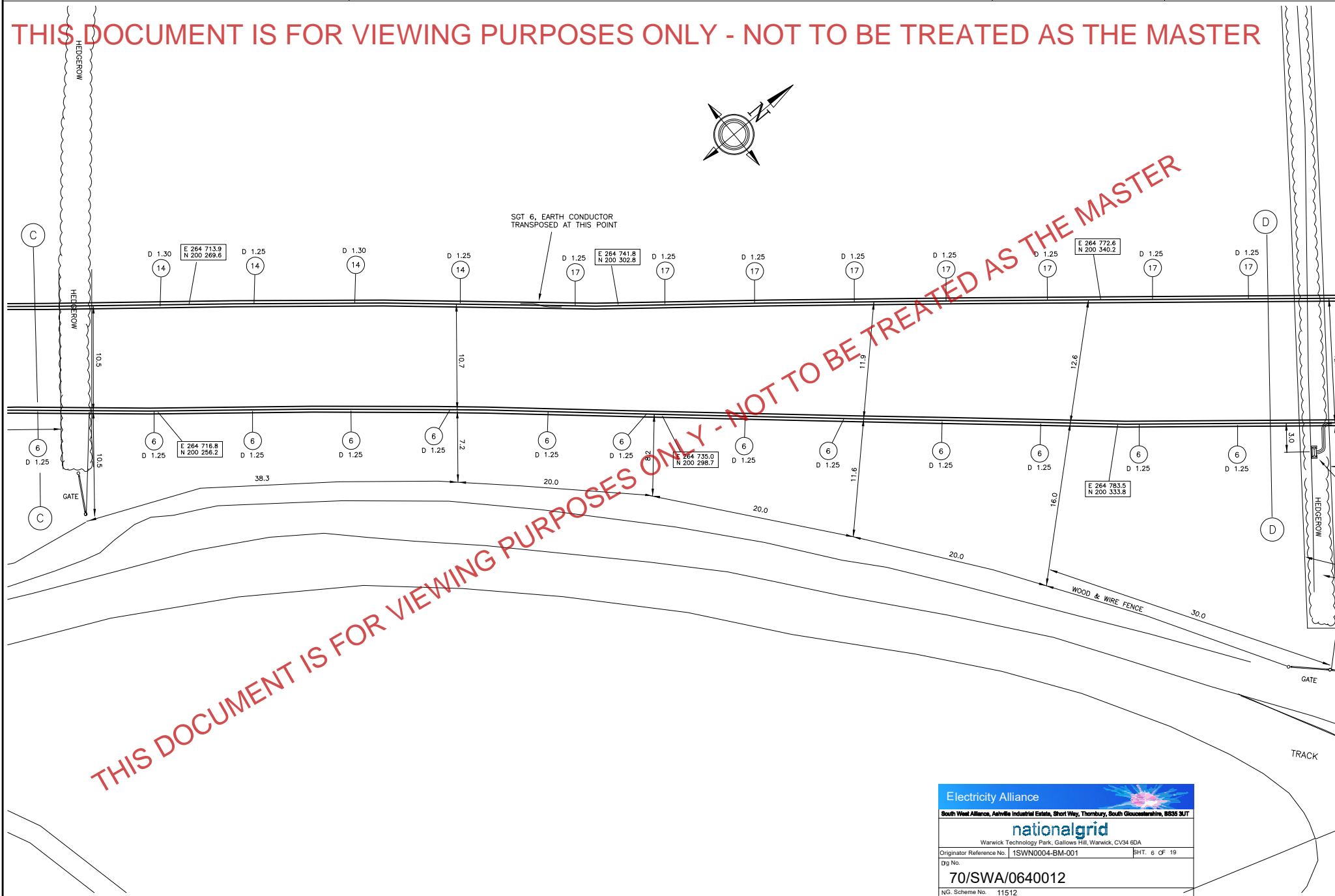
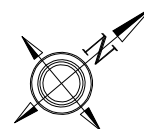

THIS DOCUMENT IS FOR VIEWING PURPOSES ONLY - NOT TO BE TREATED AS THE MASTER

Electricity Alliance

South West Alliance, Ashville Industrial Estate, Short Way, Thornbury, South Gloucestershire, BS35 9LT

**nationalgrid**

Warwick Technology Park, Galloway Hill, Warwick, CV34 6DA

Originator Reference No. 1SWN0004-BM-001 SHT. 6 OF 19

Dg No.

**70/SWA/0640012**

NG Scheme No. 11512

DRAWN	S.P.	DATE	24.6.11	SCALE: 1/250	DRAWING SIZE: A2
CHECKED	M.M	DATE	4.11.11		
NAT GRID PROJECT REF		IR11512		DRG No.	
PRYSMAN CONTRACT No.		1SWN-0004		<b>1SWN0004-BM-001 SHT 6</b>	

E tectricity Alliance

National Grid

REV	TITLE	CHK'D	DATE
A	SWA TITLE BLOCK AND DRG NO ADDED TO THIS INSTRUCTION, CHECKED AS BUILT. SCHEME 11512	PRYSMAN	13/05/13

CABLE RECORDS FOR:

**SWANSEA NORTH 132kV - 400kV GIS SUBSTATION**

**SGT6 & SGT7 CIRCUITS**

THIS DOCUMENT IS FOR VIEWING PURPOSES ONLY - NOT TO BE TREATED AS THE MASTER

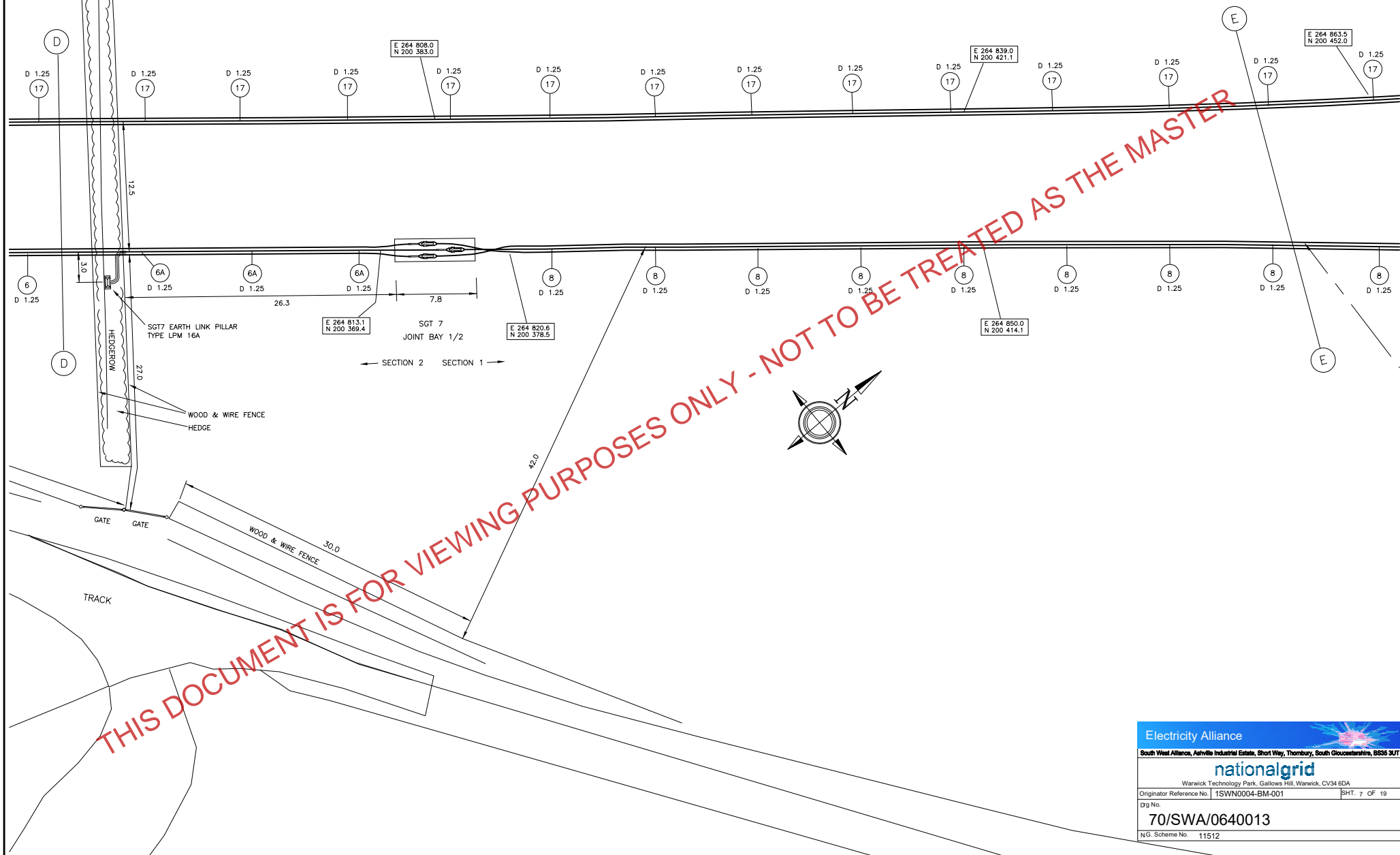

THIS DOCUMENT IS FOR VIEWING PURPOSES ONLY - NOT TO BE TREATED AS THE MASTER

Electricity Alliance  
 South West Alliance, Ashville Industrial Estate, Short Way, Thornbury, South Gloucestershire, BS36 3UT  
**nationalgrid**  
 Warwick Technology Park, Gallows Hill, Warwick, CV34 6DA  
 Originator Reference No. | 1SWN0004-BM-001 | SHT. 7 OF 19  
 Drg No.  
**70/SWA/0640013**  
 NG. Scheme No. 11512

				CABLE RECORDS FOR: <b>SWANSEA NORTH 132kV - 400kV GIS SUBSTATION</b> <b>SGT6 &amp; SGT7 CIRCUITS</b>		DRAWN S.P. DATE 24.6.11 CHECKED M.M DATE 4.11.11 NAT GRID PROJECT REF IR11512 PRYSMAN CONTRACT No. 1SWN-0004	SCALE: 1/250 DRG No. <b>1SWN0004-BM-001 SHT 7</b>
REV	TITLE	CHK'D	DATE				
A	SHA TITLE BLOCK AND DRG NO ADDED TO PWS INSTRUCTIONS. VERIFIED AS BUILT. SCHEME 11512	PRYSMAN	13/05/13				

THIS DOCUMENT IS FOR VIEWING PURPOSES ONLY - NOT TO BE TREATED AS THE MASTER

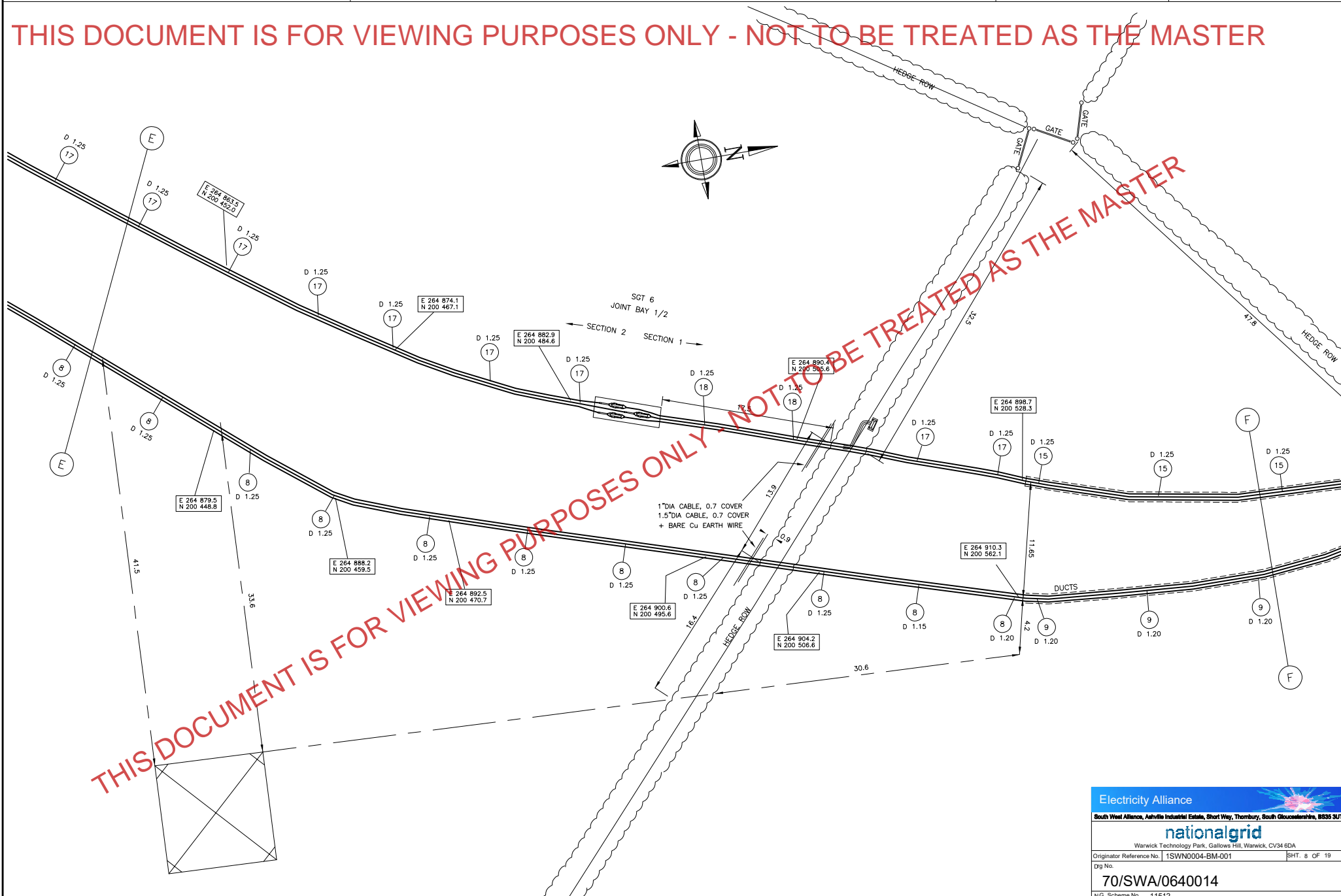

Electricity Alliance  
 South West Alliance, Ashville Industrial Estate, Short Way, Thornbury, South Gloucestershire, BS35 3UT

**nationalgrid**  
 Warwick Technology Park, Galloway Hill, Warwick, CV34 6DA

Originator Reference No. | 1SWN0004-BM-001 | SHT: 8 OF 19  
 Dwg No.  
**70/SWA/0640014**  
 N.G. Scheme No. | 11512

E tectricity Alliance

REV	TITLE	CHK'D	DATE
A	SHA TITLE BLOCK AND DRG NO ADDED TO PWS INSTRUCTIONS, VERIFIED AS BUILT - SCHEME 11512	PRYSMAN	13/05/13

CABLE RECORDS FOR:  
**SWANSEA NORTH 132KV - 400KV GIS SUBSTATION**  
**SGT6 & SGT7 CIRCUITS**

DRAWN	S.P.	DATE	24.6.11
CHECKED	M.M	DATE	4.11.11
NAT GRID PROJECT REF	IR11512		
PRYSMAN CONTRACT No.	1SWN-0004		

SCALE:	1/250	DRAWING SIZE:	A2
DRG No.	<b>1SWN0004-BM-001 SHT 8</b>		

THIS DOCUMENT IS FOR VIEWING PURPOSES ONLY - NOT TO BE TREATED AS THE MASTER

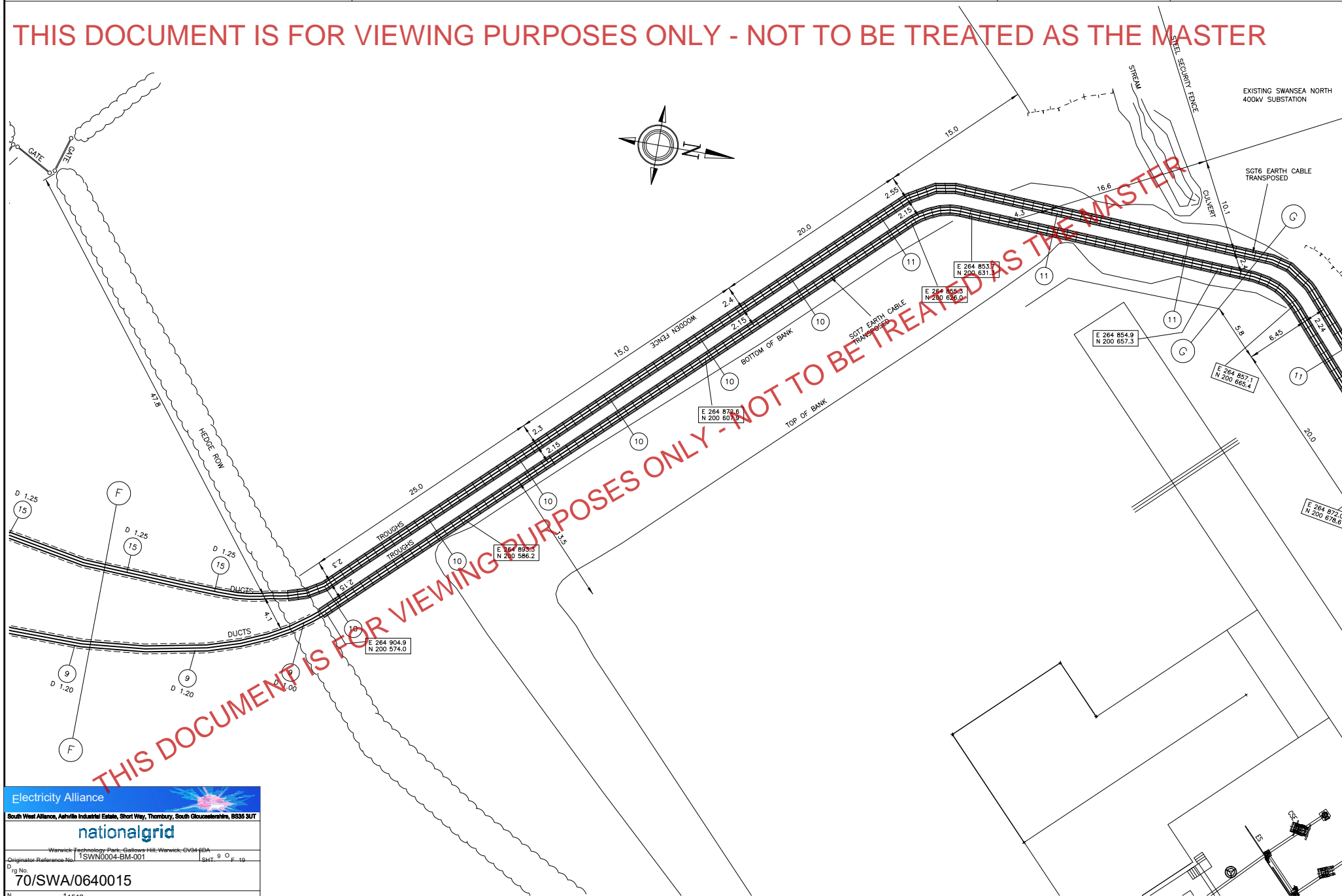

THIS DOCUMENT IS FOR VIEWING PURPOSES ONLY - NOT TO BE TREATED AS THE MASTER

Electricity Alliance  
 South West Alliance, Ashville Industrial Estate, Short Way, Thornbury, South Gloucestershire, BS35 5UT

**nationalgrid**

Wanwick Technology Park, Gallows Hill, Wanwick, CV34 6DA  
 Originator Reference No. | 1SWN0004-BM-001 | Sht. 9 of 19

Fig No.  
**70/SWA/0640015**

N. of Contract No. 11512

Electricity Alliance

**National Grid**

REV	TITLE	CHK'D	DATE
A	ON TITLE BLOCK AND SHD BE ADDED TO PHS INSTRUCTION, VERIFIED AS BUILT, SCHEME 11512	PRYSMAN	13/06/13
B	FUTURE SGT10 DELETED, VERIFIED AS BUILT, SCHEME 11512	PRYSMAN	07/06/13

CABLE RECORDS FOR:

SWANSEA NORTH 132kV - 400kV GIS SUBSTATION  
SGT6 & SGT7 CIRCUITS

DRAWN	S.P.	DATE	24.6.11
CHECKED	M.M	DATE	4.11.11
NAT GRID PROJECT REF		IR11512	
PRYSMAN CONTRACT No.		1SWN-0004	

SCALE: 1/250	DRAWING SIZE: A2
DRG No.	<b>1SWN0004-BM-001 SHT 9</b>

THIS DOCUMENT IS FOR VIEWING PURPOSES ONLY - NOT TO BE TREATED AS THE MASTER

EXISTING SWANSEA NORTH 400KV SUBSTATION



SGT6 EARTH CABLE TRANSPOSED

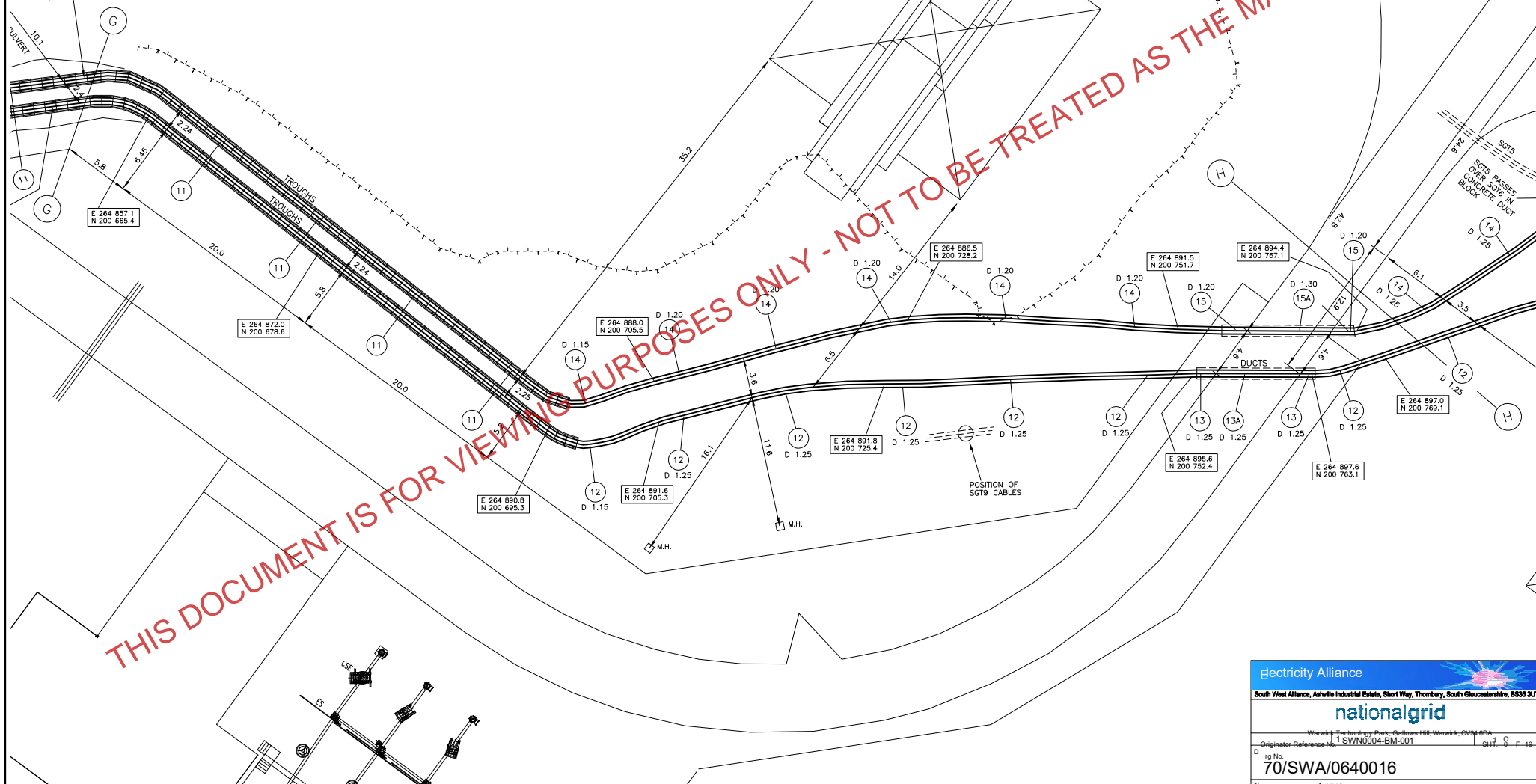

THIS DOCUMENT IS FOR VIEWING PURPOSES ONLY - NOT TO BE TREATED AS THE MASTER

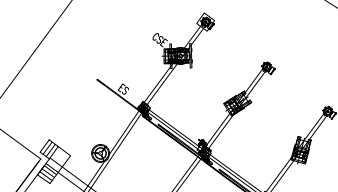

Electricity Alliance  
 South West Alliance, Ashville Industrial Estate, Short Way, Thornbury, South Gloucestershire, BS36 5UT

**nationalgrid**

Warwick Technology Park, Gallops Hill, Warwick, CV4 9EA  
 Originator Reference No. 1 SWN0004-BM-001

DRG No. **70/SWA/0640016**

N 11512

Electricity Alliance

National Grid

REV	TITLE	CHK'D	DATE
A	ISSUE TITLE BLOCK AND DEDICATED TO PWS INSTRUCTION. SGT6 AS BUILT. SCHEME 11512	PRYSMIAN	13/05/13
B	FUTURE SGT10 DELETED. VERIFIED AS BUILT. SCHEME 11512	PRYSMIAN	07/06/13

CABLE RECORDS FOR:

**SWANSEA NORTH 132KV - 400KV GIS SUBSTATION**  
**SGT6 & SGT7 CIRCUITS**

DRAWN	S.P.	DATE	24.6.11
CHECKED	M.M	DATE	4.11.11
NAT GRID PROJECT REF	IR11512		
PRYSMIAN CONTRACT No.	1SWN-0004		

SCALE:	1/250	DRAWING SIZE:	A2
DRG No.	<b>1SWN0004-BM-001 SHT 10</b>		

THIS DOCUMENT IS FOR VIEWING PURPOSES ONLY - NOT TO BE TREATED AS THE MASTER

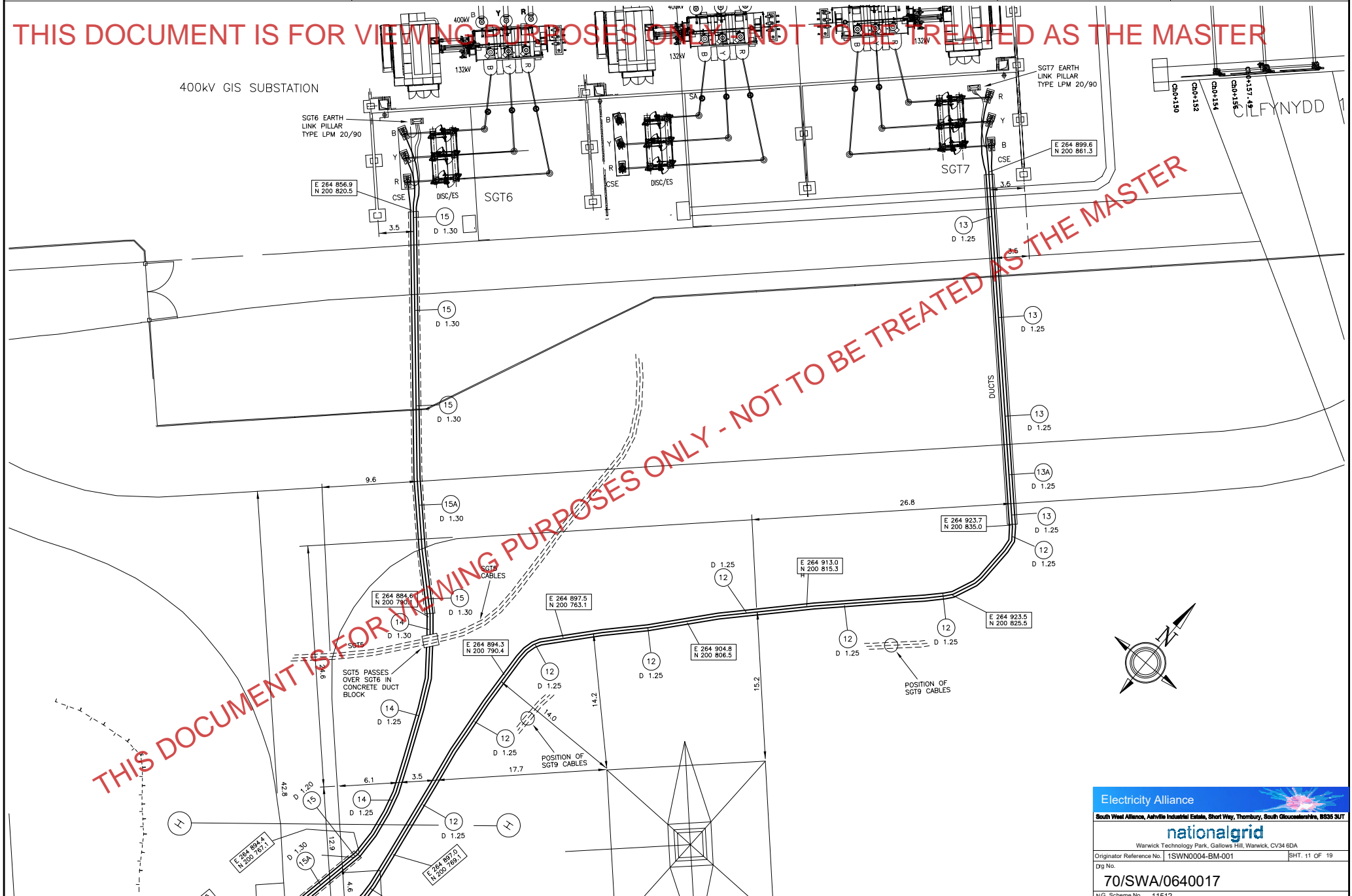

THIS DOCUMENT IS FOR VIEWING PURPOSES ONLY - NOT TO BE TREATED AS THE MASTER

Electricity Alliance  
 South West Alliance, Ashville Industrial Estate, Short Way, Thornbury, South Gloucestershire, BS35 3UT

**nationalgrid**  
 Warwick Technology Park, Galloway Hill, Warwick, CV34 6DA

Originator Reference No. | SWN0004-BM-001 | SHT. 11 OF 19  
 Dwg No.  
**70/SWA/0640017**  
 N.G. Scheme No. 11512

E tectricity Alliance

National Grid

REV	TITLE	CHK'D	DATE
A	SHA TITLE BLOCK AND DRG NO ADDED TO PWS INSTRUCTION, VERIFIED AS BUILT - SCHEME 11512	PRYSMAN	13/05/13

CABLE RECORDS FOR:

**SWANSEA NORTH 132kV - 400kV GIS SUBSTATION**  
**SGT6 & SGT7 CIRCUITS**

DRAWN	S.P.	DATE	24.6.11
CHECKED	M.M	DATE	4.11.11
NAT GRID PROJECT REF	IR11512		
PRYSMAN CONTRACT No.	1SWN-0004		

SCALE:	1/250	DRAWING SIZE:	A2
DRG No.	<b>1SWN0004-BM-001 SHT 11</b>		

THIS DOCUMENT IS FOR VIEWING PURPOSES ONLY - NOT TO BE TREATED AS THE MASTER

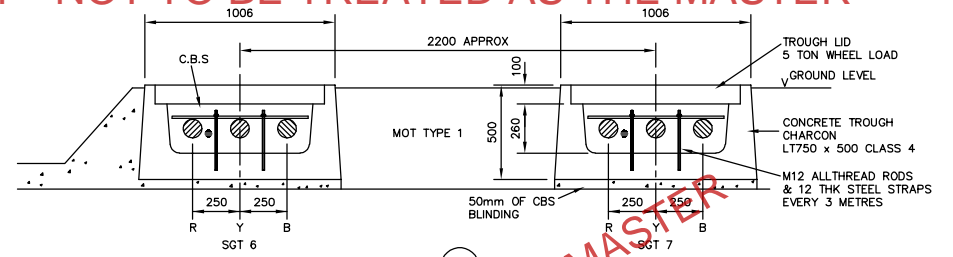
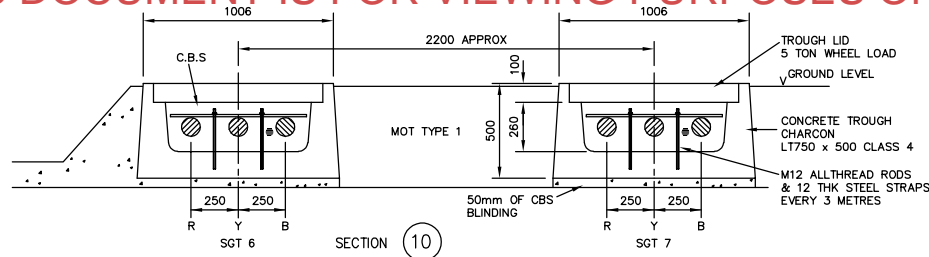

COMMON DETAILS:

- BLACK/YELLOW CAUTION TAPE
- 300 WIDE 'STOKBOARD' CABLE COVER 'CAUTION 132kV CABLES BELOW'
- 132kV CABLE
- 500sq mm S/C EARTH INTERCONNECTOR
- 150 I/D 160 O/D U-PVC DUCT
- 100 I/D U-PVC DUCT

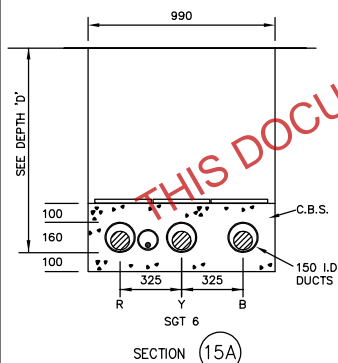
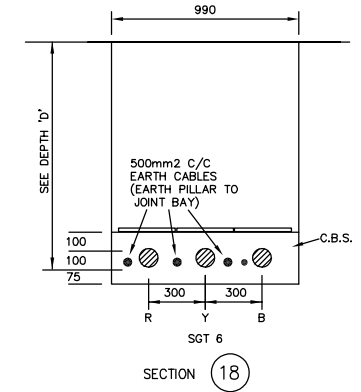
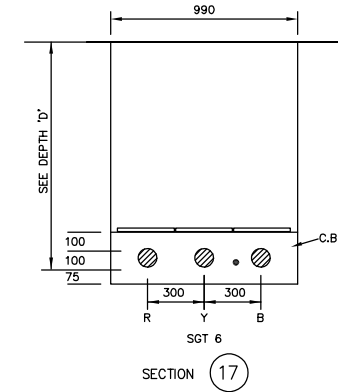
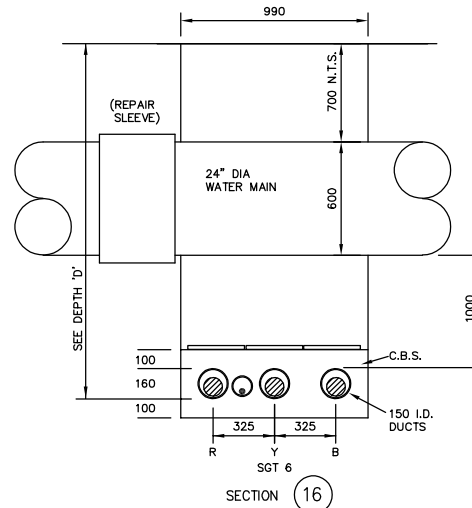
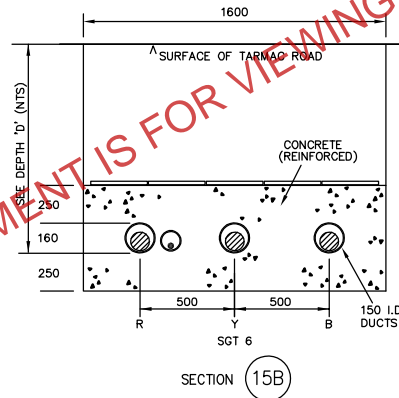
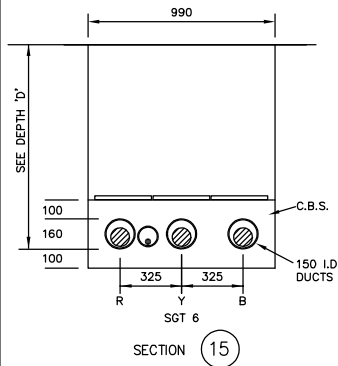
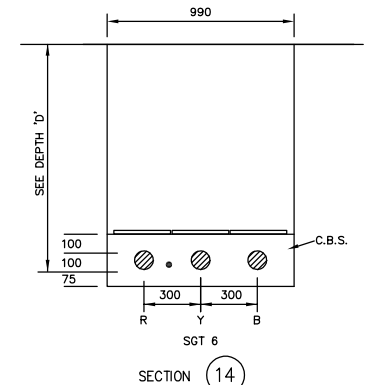
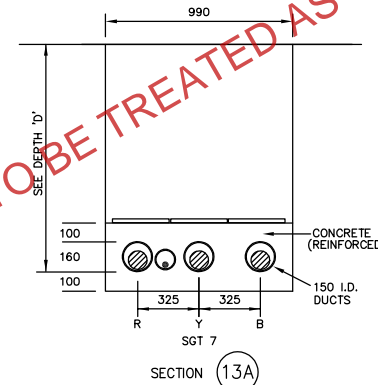
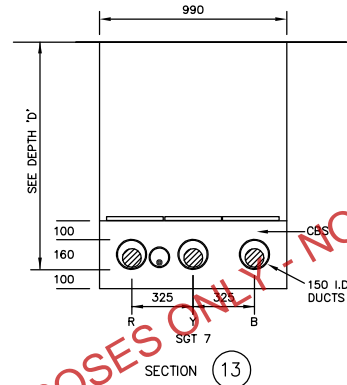
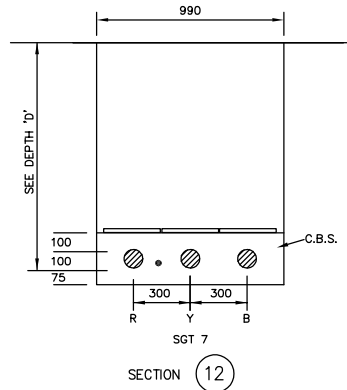

THIS DOCUMENT IS FOR VIEWING PURPOSES ONLY - NOT TO BE TREATED AS THE MASTER

Electricity Alliance  
 South West Alliance, Avonmouth Island Cable, Bland Vols, Thornbury, South Gloucestershire, WSSB J21  
**nationalgrid**  
 Warwick Technology Park, Galsworthy, Walsley, CV36 4DA  
 Originator Reference No: | SWN0004-BM-001 | SHT: 13 OF 19  
 Dwg No: 70/SWA/0640019  
 N.D. Scheme No: 11512

E tricity Alliance

REV	TITLE	CHK'D	DATE
A	SHA TITLE BLOCK AND PART NO. ADDED TO THIS INSTRUCTION, REPROD AS BUIL. C. SCHEME 11512.	PRYSMAN	13/05/13

CABLE RECORDS FOR:  
**SWANSEA NORTH 400kV TO 132kV SUBSTATIONS**  
**SGT6 & SGT7 CIRCUITS**

DRAWN	S.P.	DATE	24.6.11
CHECKED	M.M	DATE	4.11.11
NAT GRID PROJECT REF	IR11512		
PRYSMAN CONTRACT No.	1SWN-0004		

SCALE: 1/20  
 DRG No.  
**1SWN0004-BM-001 SHT 13**  
 DRAWING SIZE: A2

THIS DOCUMENT IS FOR VIEWING PURPOSES ONLY - NOT TO BE TREATED AS THE MASTER

SECTIONS LOOKING NORTH - TO GIS SUBSTATION

COMMON DETAILS:

- BLACK/YELLOW CAUTION TAPE
- 300 WIDE 'STOKBOARD' CABLE COVER  
'CAUTION 132kV CABLES BELOW'
- ⊗ 132kV CABLE
- 500sq mm S/C EARTH INTERCONNECTOR
- 150 I/D 160 O/D U-PVC DUCT
- 100 I/D U-PVC DUCT

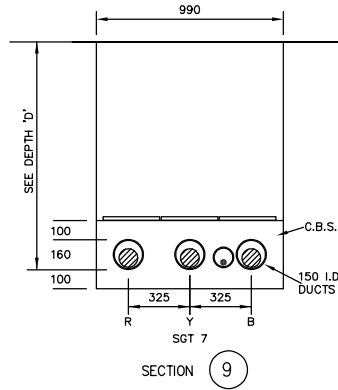
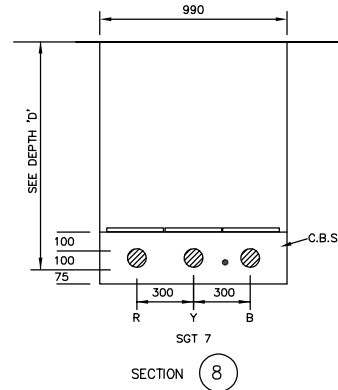
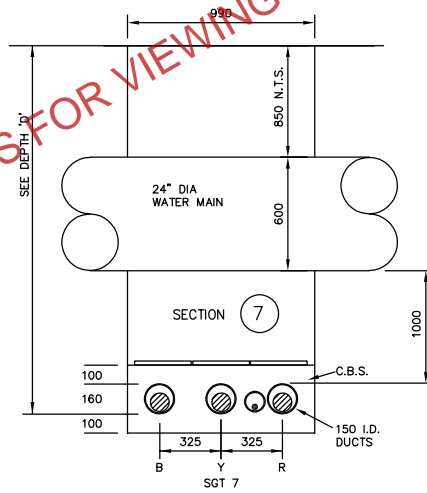
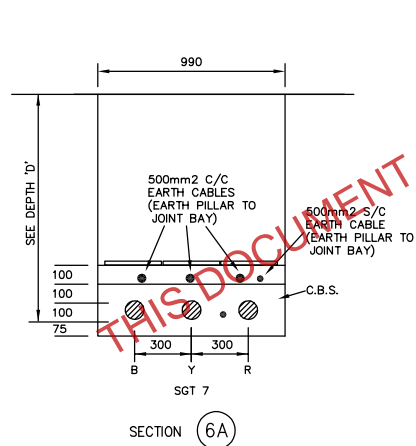
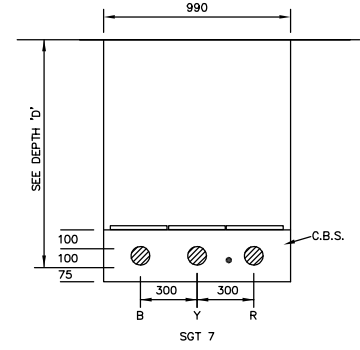
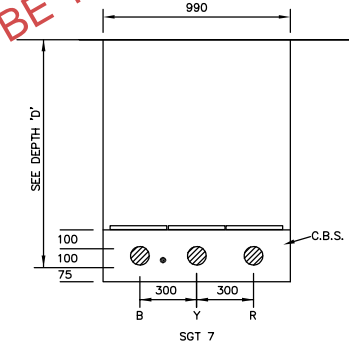
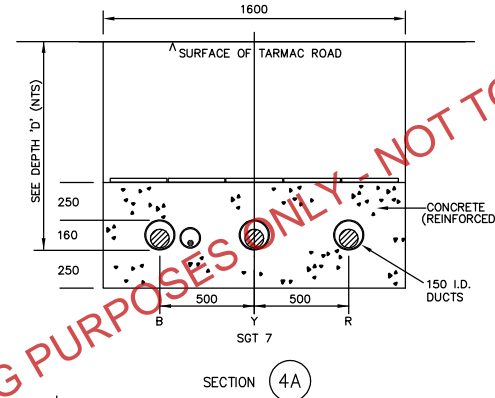
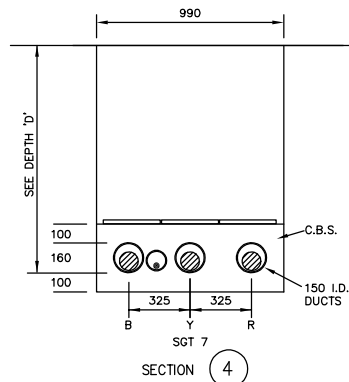
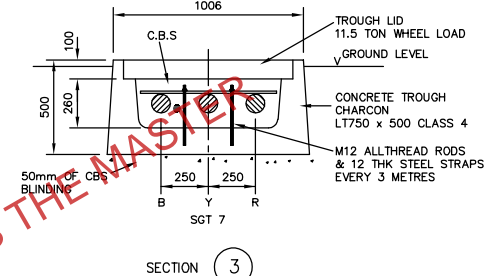
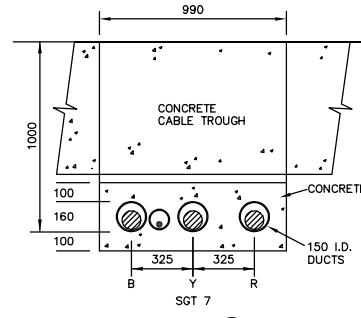
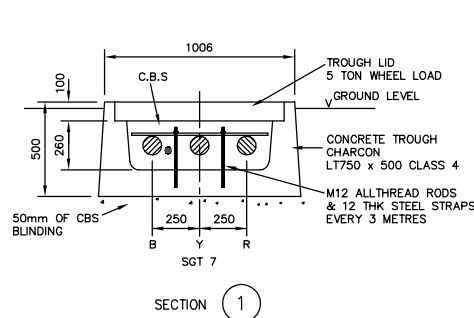

THIS DOCUMENT IS FOR VIEWING PURPOSES ONLY - NOT TO BE TREATED AS THE MASTER

Electricity Alliance  
 Warwick Technology Park, Galloway Hill, Warwick, CV34 6DA  
**nationalgrid**  
 Originator Reference No. | 1SWN0004-BM-001 | SHT. 12 OF 19  
 Drg No.  
**70/SWA/0640018**  
 N.G. Scheme No. | 11512

E tricity Alliance  
**National Grid**

REV	TITLE	CHK'D	DATE
A	DRG TITLE BLOCK AND BUBBLES ADDED TO THIS INSTRUCTION, REPROD AS BUIL. SCHEME 11512.	PRYSMAN	13/05/13

CABLE RECORDS FOR:  
**SWANSEA NORTH 400kV TO 132kV SUBSTATIONS**  
**SGT6 & SGT7 CIRCUITS**

DRAWN	S.P.	DATE	24.6.11
CHECKED	M.M	DATE	4.11.11
NAT GRID PROJECT REF	IR11512		
PRYSMAN CONTRACT No.	1SWN-0004		

SCALE:	1/20	DRAWING SIZE:	A2
DRG No.	<b>1SWN0004-BM-001 SHT 12</b>		



# THIS DOCUMENT IS FOR VIEWING PURPOSES ONLY - NOT TO BE TREATED AS THE MASTER ELECTRICITY ALLIANCE-NATIONAL GRID

## UNDERGROUND CABLE RECORDS

LOCATION : SWANSEA NORTH: 400kV G.I.S. SUBSTATION

CIRCUITS : 400kV SGT9 CIRCUIT

PRYSMIAN CONTRACT No. 1SWN-0004  
 ALLIANCE CONTRACT No. 50050573/N06/F11  
 NATIONAL GRID PROJECT REF. IR11512

POWER CABLES:	400kV, 2500mm <sup>2</sup> SINGLE CORE Cu, XLPE, WELDED ALUMINIUM SHEATH, Pe, CABLES
AUXILIARY CABLES:	DTS FIBRE BLOWN INTO PLASTIC TUBE: 4 FIBRE MULTIMODE UNIT

ALLIANCE PROJECT MANAGER

Mr P. HAMNET

ALLIANCE ENGINEER

Mr C. McMAHON

INSTALLED ; JULY 2010 - JUNE 2011

PRESSURE TEST DATE: 14 JUNE 2011

CONTENTS

PAGE	DESCRIPTION
1	TITLE & CONTENTS SHEET (THIS SHEET)
2	KEY PLAN (1/2000)
3 & 4	CABLE ROUTE PLANS (1/250)
5	TRENCH CROSS SECTIONS
6	ARRANGEMENT OF TERMINATIONS AT GIS SUBSTATION (NORTH)
7	ARRANGEMENT OF TERMINATIONS AT SEALING ENDS (SOUTH)
8	CABLE & JOINTING SCHEDULE + SCHEMATIC BONDING DIAGRAM
9	CABLE CROSS SECTION & DETAILS
10	EARTH CABLE DETAILS

CONTRACTORS

PRYSMIAN CABLES & SYSTEMS

PRYSMIAN SITE ENGINEER

Mr M BROWN

PRYSMIAN CONTRACT MANAGER

Mr W. MILLS

DRAUGHTSMAN

Mr S PERRY

SUB CONTRACTORS (CIVLS)

NEARY CONSTRUCTION

Electricity Alliance	
<small>South West Alliance, Ashville Industrial Estate, Short Way, Thornbury, South Gloucestershire, BS35 3UT</small>	
<b>nationalgrid</b>	
<small>Warwick Technology Park, Gallow's Hill, Warwick, CV34 6DA</small>	
Originator Reference No.   1SWN0004-BM-002	BHT: 1 OF 10
Dwg No.	
<b>70/SWA/0640020</b>	
<small>NG. Scheme No. 11512</small>	

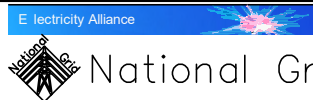

REV	TITLE	CHK'D	DATE
A	SEE TITLE BLOCK AND DRG NO ADDED TO THIS INSTRUCTION. CHECKED AS PER 10.000-10.001	PRYSMIAN	13/05/13

CABLE RECORDS FOR:

**SWANSEA NORTH 400kV GIS SUBSTATION  
400kV SGT9 CIRCUIT**

DRAWN	S.P.	DATE	23.6.11
CHECKED	M.M.	DATE	2.11.11
NAT GRID PROJECT REF	IR11512		
PRYSMIAN CONTRACT No.	1SWN-0004		

SCALE: N.T.S.	DRAWING SIZE: A2
DRG No.	
<b>1SWN0004-BM-002 SHT 1</b>	

THIS DOCUMENT IS FOR VIEWING PURPOSES ONLY - NOT TO BE TREATED AS THE MASTER

THIS DOCUMENT IS FOR VIEWING PURPOSES ONLY - NOT TO BE TREATED AS THE MASTER

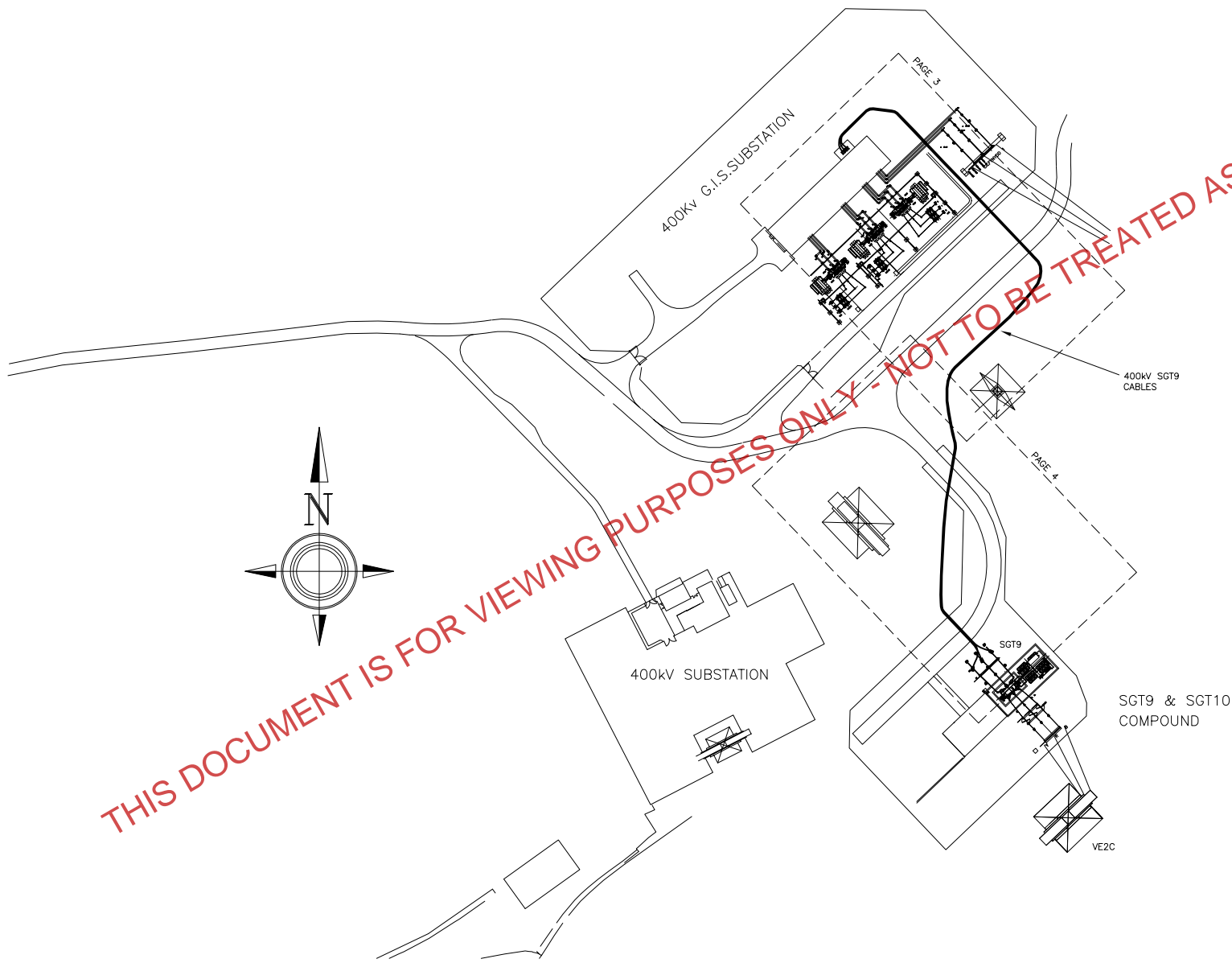

Electricity Alliance

South West Alliance, Ashville Industrial Estate, Short Way, Thornbury, South Gloucestershire, BS36 5UT

**nationalgrid**

Warwick Technology Park, Gallows Hill, Warwick, CV34 6BA

Originator Reference: 1 SWN0004-BM-002

DRG No. **70/SWA/0640021**

Nat Grid Reference: 11512

Electricity Alliance

National Grid

REV	TITLE	CHK'D	DATE
A	NEW TITLE BLOCK AND DRG NO ADDED TO PIVS INSTRUCTIONS. VERIFIED AS BUILT. SCHEME 11512	PRYSMIAN	13/05/13
B	FUTURE SGT10 DELETED. VERIFIED AS BUILT. SCHEME 11512	PRYSMIAN	07/06/13

CABLE RECORDS FOR:

**SWANSEA NORTH 400kV GIS SUBSTATION**  
**400kV SGT9 CIRCUIT**

DRAWN	S.P.	DATE	23.6.11
CHECKED	M.M.	DATE	02.11.11
NAT GRID PROJECT REF	IR11512		
PRYSMIAN CONTRACT No.	1SWN-0004		

SCALE:	1/1250	DRAWING SIZE:	A2
DRG No.	<b>1SWN0004-BM-002 SHT 2</b>		

THIS DOCUMENT IS FOR VIEWING PURPOSES ONLY - NOT TO BE TREATED AS THE MASTER

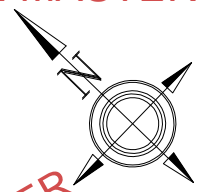
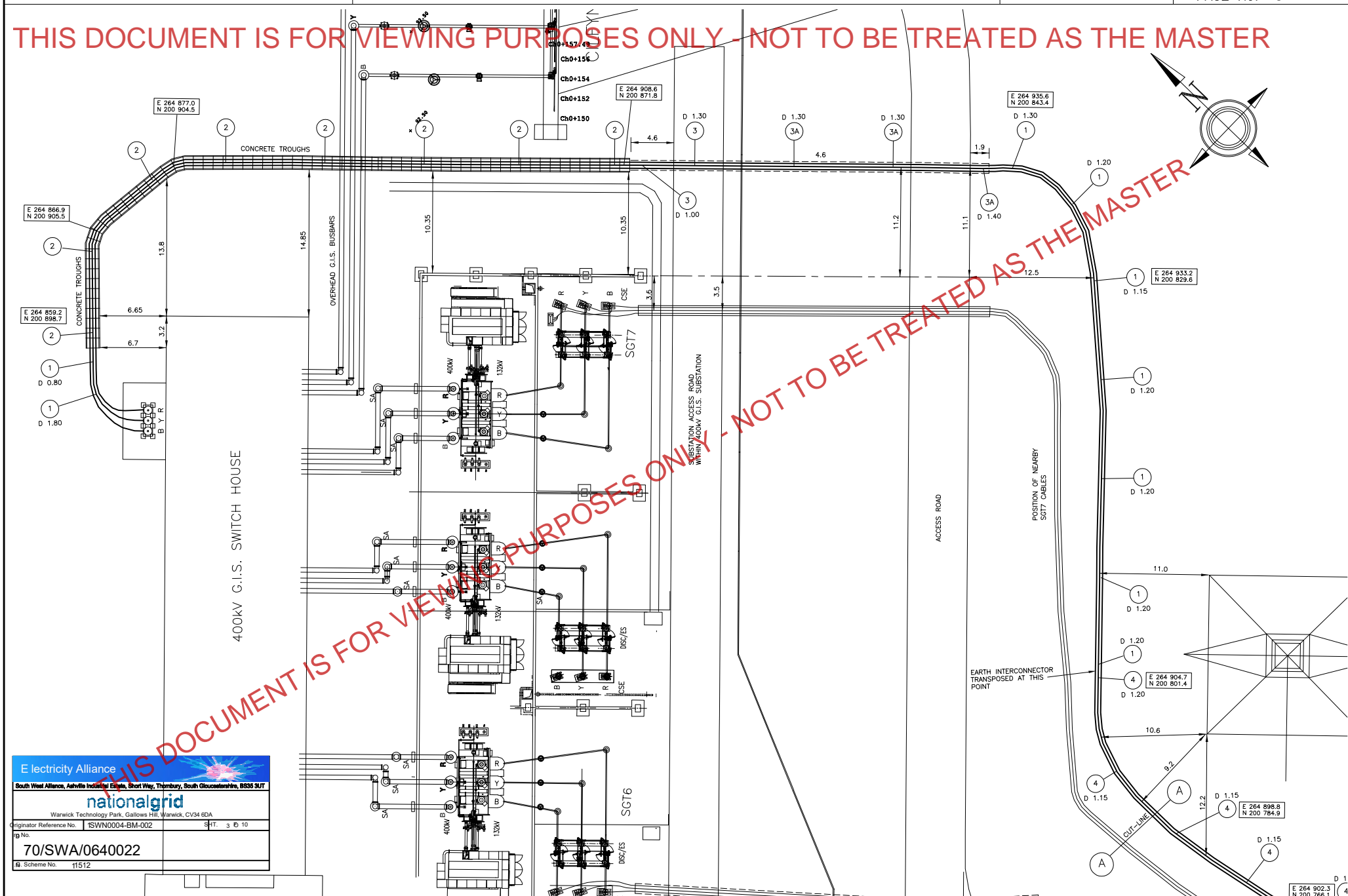

E lectricity Alliance  
 South West Alliance, Ashville Industrial Estate, Short Way, Thornbury, South Gloucestershire, BS32 9UT

**nationalgrid**  
 Warwick Technology Park, Gallows Hill, Warwick, CV34 6DA

Originator Reference No. ISWN0004-BM-002 SHT. 3 of 10

Dr No. 70/SWA/0640022

Scheme No. 11512

E lectricity Alliance

National Grid

REV	TITLE	CHK'D	DATE
A	SWA TITLE BLOCK AND DRG NO 2000 TO PWS INSTRUCTION, VERIFIED AS BUILT - SCHEME 11512	PRYSMIAN	13/05/13

CABLE RECORDS FOR:

**SWANSEA NORTH 400KV GIS SUBSTATION**  
**400KV SGT9 CIRCUIT**

DRAWN	S.P.	DATE	30.5.11
CHECKED	M.M.	DATE	2.11.11
CUSTOMER CONTRACT No.	1R11512		
PRYSMIAN CONTRACT No.	1SWN-0004		

SCALE:	1/250	DRAWING SIZE:	A2
DRG No.	1SWN0004-BM-002 SHT 3		

THIS DOCUMENT IS FOR VIEWING PURPOSES ONLY - NOT TO BE TREATED AS THE MASTER

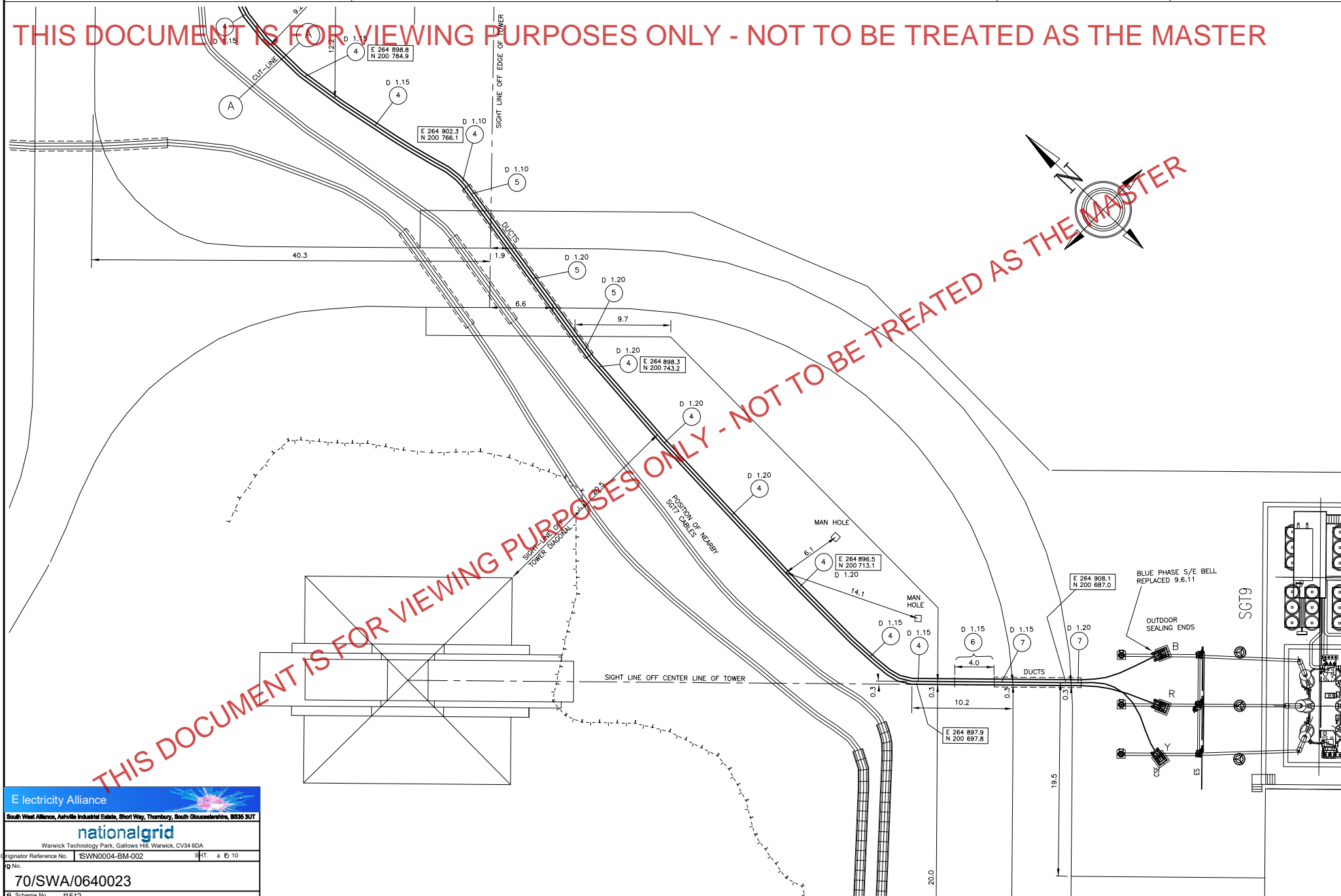

THIS DOCUMENT IS FOR VIEWING PURPOSES ONLY - NOT TO BE TREATED AS THE MASTER

**E lectricity Alliance**  
 South West Alliance, Ashville Industrial Estate, Short Way, Thornbury, South Gloucestershire, BS35 5UT

**nationalgrid**  
 Warwick Technology Park, Gallows Hill, Warwick, CV34 6DA

Originator Reference No. | SWN0004-BM-002 | SHT. 4 of 10  
 ID No.  
**70/SWA/0640023**  
 Scheme No. 11512

**E lectricity Alliance**

**National Grid**

REV	TITLE	CHK'D	DATE
A	SWA TITLE BLOCK AND DRG NO ADDED TO PWS INSTRUCTIONS. MODIFIED AS PER SCHEME 11512	PRYSMIAN	13/05/13

CABLE RECORDS FOR:

DRAWN	S.P.	DATE
		30.5.11
CHECKED	M.M.	DATE 2.11.11
CUSTOMER CONTRACT No.	IR11512	
PRYSMIAN CONTRACT No.	1SWN-0004	

**SWANSEA NORTH 400KV GIS SUBSTATION**  
**400KV SGT9 CIRCUIT**

SCALE: 1/250	DRAWING SIZE: A2
DRG No.	<b>1SWN0004-BM-002 SHT 4</b>

THIS DOCUMENT IS FOR VIEWING PURPOSES ONLY - NOT TO BE TREATED AS THE MASTER

CABLE SCHEDULE	CIRCUIT	PHASE	SIZE AND DESCRIPTION	FROM	TO	MANUFACTURER	DATE PULLED	LENGTH	DRUM No.	DIRECTION OF PULL	
	SGT9	R		400kV 2500mm <sup>2</sup> SINGLE CORE Cu, XLPE, WELDED AL SHEATH. CABLE	SGT9	400kV GIS SUBST'N	PRYSMIAN CABLES, GRON, FRANCE	11.10.10	318m	MFW 54456326	TOWARDS SGT9
		Y		400kV 2500mm <sup>2</sup> SINGLE CORE Cu, XLPE, WELDED AL SHEATH. CABLE	SGT9	400kV GIS SUBST'N	PRYSMIAN CABLES, GRON, FRANCE	12.10.10	323m	MFW 54456320	TOWARDS SGT9
		B		400kV 2500mm <sup>2</sup> SINGLE CORE Cu, XLPE, WELDED AL SHEATH. CABLE	SGT9	400kV GIS SUBST'N	PRYSMIAN CABLES, GRON, FRANCE	13.10.10	321m	MFW 54456327	TOWARDS SGT9

JOINTING SCHEDULE	CIRCUIT	POSITION OF JOINT	PHASE	TYPE AND DESCRIPTION	JOINT DRG No.	JOINTER	DATE JOINED	WEATHER	
	SGT9	S/Es	ADJ TO SGT9	R	400kV XLPE OUTDOOR SEALING END, TYPE TES 1420/115	41.148.2.273	D CRAIG + N CHALK	29.11.10	DRY
		S/Es	ADJ TO SGT9	Y	400kV XLPE OUTDOOR SEALING END, TYPE TES 1420/115	41.148.2.273	D CRAIG + N CHALK	29.11.10	DRY
		S/Es	ADJ TO SGT9	B	400kV XLPE OUTDOOR SEALING END, TYPE TES 1420/115	41.148.2.273	D CRAIG + N CHALK	29.11.10	DRY
		SF6	S/Es IN GIS SUBSTATION	R	400kV SF6 SEALING END	41.450.5.531	N HUNTER + N CHALK	20.5.11	DRY
		SF6	S/Es IN GIS SUBSTATION	Y	400kV SF6 SEALING END	41.450.5.531	N HUNTER + N CHALK	20.5.11	DRY
		SF6	S/Es IN GIS SUBSTATION	B	400kV SF6 SEALING END	41.450.5.531	N HUNTER + N CHALK	20.5.11	DRY

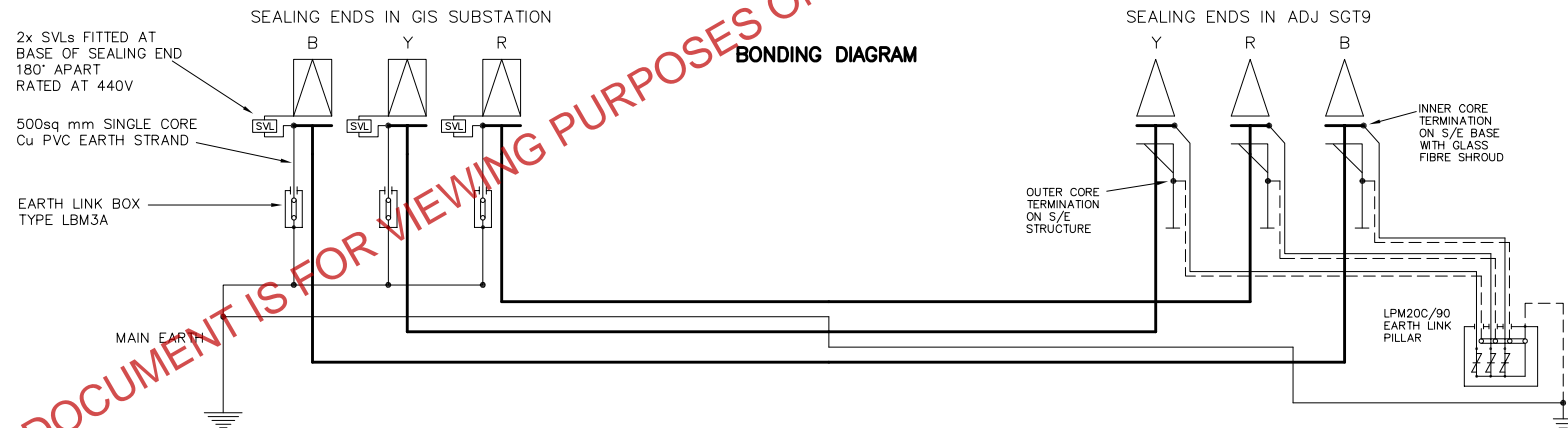

**LEGEND**

EARTH CABLES:  
 ——— 500sq mm S/C  
 (INNER CORE) ——— 500sq mm C/C  
 (OUTER CORE) - - - - 120sq mm S/C

POWER CABLE:  
 ——— 2500sq mm S/C



SF6 SEALING END



OUTDOOR SEALING END

Electricity Alliance

South West Albany, Ashfield Industrial Estate, Great Way, Thornbury, South Gloucestershire, BS20 5JL

**nationalgrid**

Warwick Technology Park, Grafton Rd, Warwick, CV34 6EF

Original Reference No. 1SWN004-BM-002 Part: 8 Of 10

Drwg No. 70/SWA/0640024

N.G. Scheme No. 11512

SCALE: N.T.S. DRAWING SIZE: A2

DRG No. 1SWN004-BM-002 SHT 8

Electricity Alliance



National Grid

REV	TITLE	CHK'D	DATE
A	SWA TITLE BLOCK AND DRG NO ADDED TO PWS INSTRUCTION. VERIFIED AS BUILT. SCHEME 11512	PRYSMIAN	13/05/13

CABLE RECORDS FOR:

**SWANSEA NORTH 400kV GIS SUBSTATION**  
**400kV SGT9 CIRCUIT**

DRAWN	S.P.	DATE
		30.5.11
CHECKED	M.M.	DATE
		2.11.11
NAT GRID PROJECT REF	IR11512	
PRYSMIAN CONTRACT No.	1SWN-0004	

SCALE: N.T.S. DRAWING SIZE: A2

DRG No. 1SWN004-BM-002 SHT 8

Your search has returned a fibre optic cable(s)

The cable(s) returned are the responsibility of Vodafone UK and as such a new street works enquiry relating to these cables should be addressed to the Vodafone Streetworks Office.

[osm.enquiries@atkinsglobal.com](mailto:osm.enquiries@atkinsglobal.com)

(Attach the planned response you have received from LSBUD).

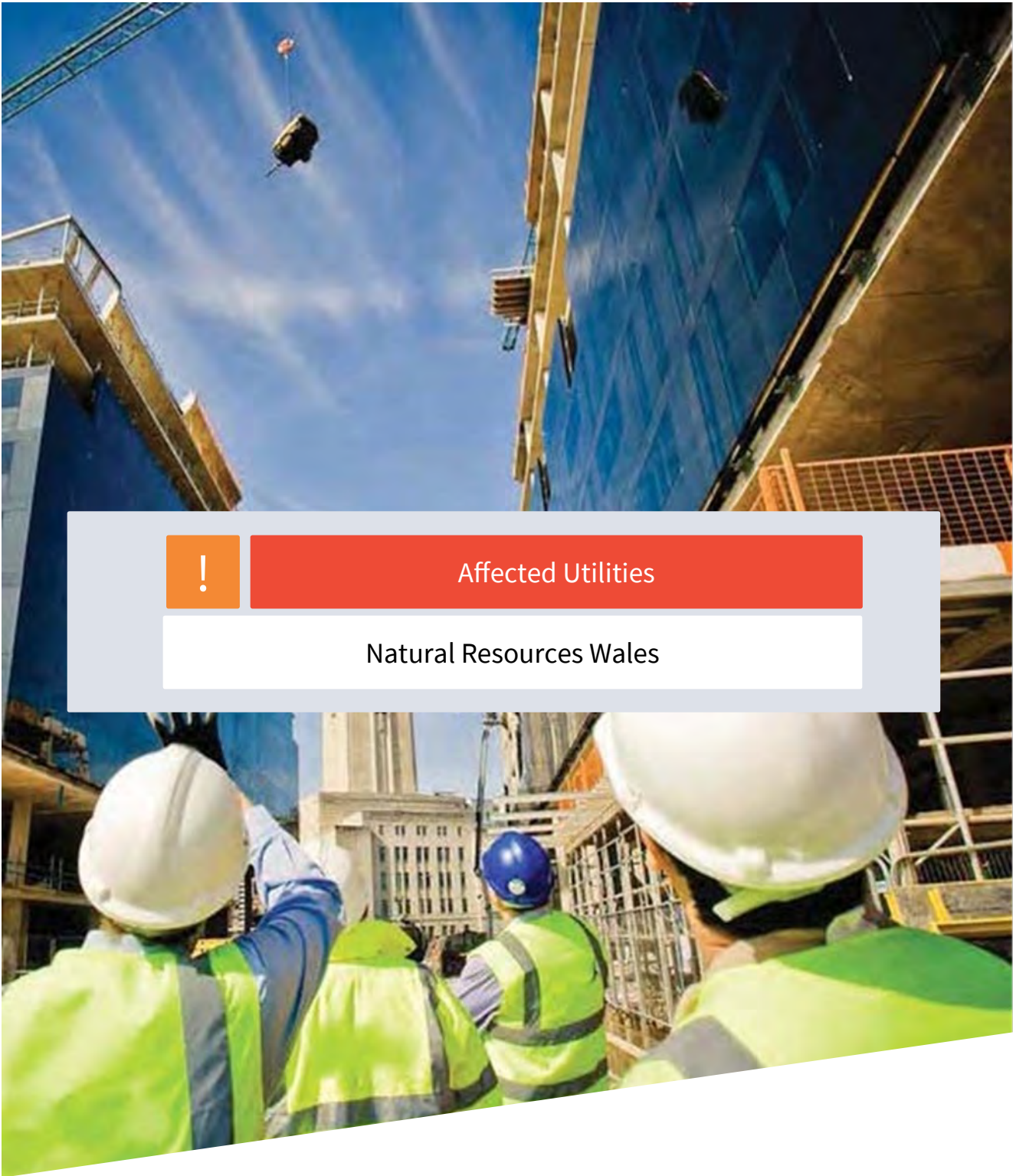

Affected Utilities

Natural Resources Wales



**Cyfoeth  
Naturiol  
Cymru  
Natural  
Resources  
Wales**

Ein cyf/Our ref: Atkins Plant Enquiries

Ebost/Email:  
[datadistribution@cyfoethnaturiolcymru.gov.uk](mailto:datadistribution@cyfoethnaturiolcymru.gov.uk)

Ffôn/Phone: 0300 065 3000

To: [atkinsstatutory.enquiries@atkinsglobal.com](mailto:atkinsstatutory.enquiries@atkinsglobal.com)

Dear Sir / Madam,

The process by which Natural Resources Wales responds to plant / asset enquiries has changed since August 2016.

We no longer carry out any checks on the sites in question, either on our mapping system or with internal teams. We ask that in the first instance organisations make their own checks via various links. These are as follows:

If you want to carry out works in, over, under or near a main river or flood defence (including a sea defence), or within a flood plain you will need to apply for Flood Risk Activity Permit. (This was previously called a Flood Defence Consent.) For further advice please visit our website <http://naturalresources.wales/apply-for-a-permit/flood-risk-activities/?lang=en>  
Contact details for the relevant office are also included within the application forms.

For locations of main rivers, flood defences and flood plains, you can view our Risk of Flooding maps online at this link <https://naturalresources.wales/our-evidence-and-reports/maps/flood-risk-map/?lang=en>

You can download GIS data on the locations of designated sites from the Lle web portal <http://lle.wales.gov.uk/catalogue?lang=en>

Further information about these sites can also be found on our website <http://naturalresources.wales/conservation-biodiversity-and-wildlife/find-protected-areas-of-land-and-seas/designated-sites-search/?lang=en>

Please note - although Natural Resources Wales is classed as a statutory undertaker, we do not generally have plant equipment or pipelines situated in the public highway.

To confirm: **Natural Resources Wales has not conducted a specific search of our records.** After checking the above links, if you have reason to think that your proposal will affect land or equipment which we own, please submit your enquiry to [datadistribution@naturalresourceswales.gov.uk](mailto:datadistribution@naturalresourceswales.gov.uk) with details of the specific areas affected.

Yours sincerely

Tim Cysylltiadau Allanol / **External Relations Team**  
Cyfoeth Naturiol Cymru / **Natural Resources Wales**



## Standard Notice

(not for use with Special Data, Personal Data or unlicensed 3<sup>rd</sup> party rights)

### **Information warning**

We (Natural Resources Wales) do not promise that the Information supplied to You will always be accurate, free from viruses and other malicious or damaging code (if electronic), complete or up to date or that the Information will provide any particular facilities or functions or be suitable for any particular purpose. You must ensure that the Information meets your needs and are entirely responsible for the consequences of using the Information. Please also note any specific information warning or guidance supplied to you.



### **Permitted use**

- The Information is protected by intellectual property rights and whilst you have certain statutory rights which include the right to read the Information, you are granted no additional use rights whatsoever unless you agree to the licence set out below.
- Commercial use of anything except EA OpenData is subject to payment of a £50 licence fee (+VAT) for each person seeking the benefit of the licence, except for use as an Natural Resources Wales contractor or for approved media use.
- To activate this licence you do not need to contact us (unless you need to pay us a Commercial licence fee) but if you make any use in excess of your statutory rights you are deemed to accept the terms below.



### **Licence**

We grant you a worldwide, royalty-free (apart from the £50 licence fee for commercial use), perpetual, non-exclusive licence to use the Information subject to the conditions below.

### **You are free to:**

-  copy, publish, distribute and transmit the Information
-  adapt the Information
-  exploit the Information commercially, for example, by combining it with other Information, or by including it in your own product or application

### **You must (where you do any of the above):**

-  acknowledge the source of the Information by including the following attribution statement:  
“Contains Natural Resources Wales information © Natural Resources Wales and database right” ensure that you do not use the Information in a way that suggests any official status or that We endorse you or your use of the Information
-  ensure that you do not mislead others or misrepresent the Information or its source or use the Information in a way that is detrimental to the environment, including the risk of reduced future enhancement
-  ensure that your use of the Information does not breach the Data Protection Act 1998 or the Privacy and Electronic Communications (EC Directive) Regulations 2003

These are important conditions and if you fail to comply with them the rights granted to you under this licence, or any similar licence granted by us will end automatically.

### **No warranty**

The Information is licensed ‘as is’ and We exclude all representations, warranties, obligations and liabilities in relation to the Information to the maximum extent permitted by law. We are not liable for any errors or omissions in the Information and shall not be liable for any loss, injury or damage of any kind caused by its use. We do not guarantee the continued supply of the Information.



### **Governing Law**

This licence is governed by the laws of England and Wales.

### **Definitions**

“Information” means the information that is protected by copyright or by database right (for example, literary and artistic works, content, data and source code) offered for use under the terms of this licence.

“Commercial” means:

-  offering a product or service containing the Information, or any adaptation of it, for a charge, or
-  internal use for any purpose, or offering a product or service based on the Information for indirect commercial advantage, by an organisation that is primarily engaged in trade, commerce or a profession.

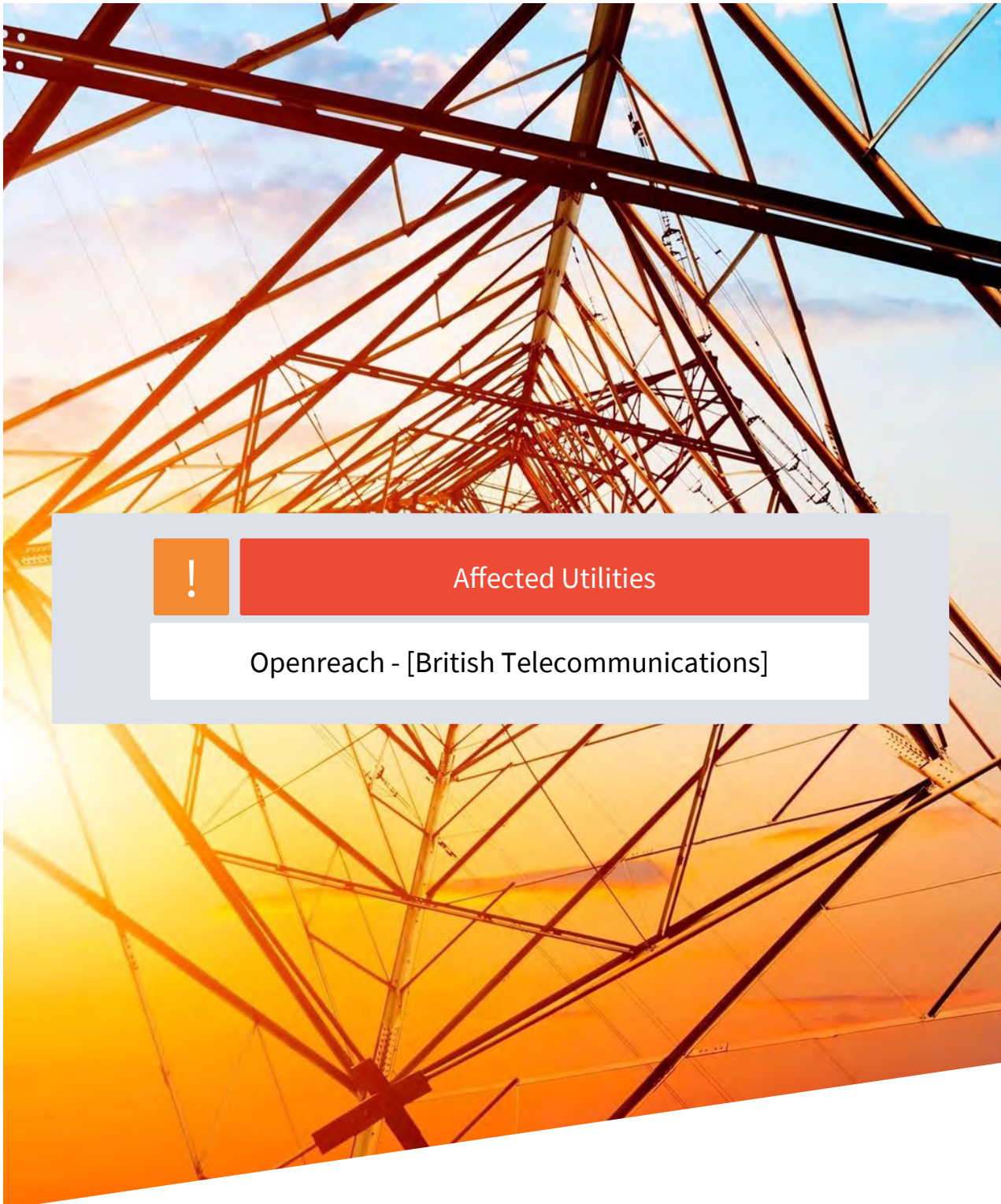

Affected Utilities

Openreach - [British Telecommunications]

CHECKED

openreach

Our Ref: Ref shown on map

Date of issue: shown on map

email: [nnhc@openreach.co.uk](mailto:nnhc@openreach.co.uk)

Dear Customer,

**NR & SW ACT 1991 – PROPOSED WORKS AT: \*\*SITE LOCATION\*\***

Prior to commencement of work: For free onsite guidance and accurate up to date location of BT Apparatus please contact our Plant Protection Service by the following methods:-

Email the Click Before You Dig Team [CBYD@openreach.co.uk](mailto:CBYD@openreach.co.uk)

Visit the Click Before You Dig Website [www.openreach.co.uk/cbyd](http://www.openreach.co.uk/cbyd)

Thank you for your request of \*\*/\*\*/\*\* describing the above proposals.

Enclosed are copies of our drawings marked up to show the approximate locations of BT apparatus in the immediate vicinity of your works. It is intended for general guidance only. No guarantee is given of its accuracy.

The drawings are valid for 90 days from the date of issue and should not be relied upon after this time period has expired.

When planning excavation work or other works near to BT apparatus, please be mindful our apparatus may exist at various depths and may deviate from the marked route.

To avoid damage it is recommended that mechanical excavators or borers are not used within 600mm of BT apparatus. If scaffolding is erected, please ensure that our equipment is not enclosed, blocked, covered or otherwise obstructed by the scaffolding.

In the event of BT apparatus being in the area of your works we recommend that your plant/vehicle crossing is either resited, or apply for a budget estimate by submitting detailed plans to our Network Relocation Team at <https://www.ournetwork.openreach.co.uk/altering-our-network.aspx>

Yours faithfully,

**Julie Cullum**  
**NNHC & MBE Manager**

# Maps by email Plant Information Reply



## IMPORTANT WARNING

Information regarding the location of BT apparatus is given for your assistance and is intended for general guidance only. No guarantee is given of its accuracy. It should not be relied upon in the event of excavations or other works being made near to BT apparatus which may exist at various depths and may deviate from the marked route.



**openreach**

### CLICK BEFORE YOU DIG

FOR PROFESSIONAL FREE ON SITE ASSISTANCE PRIOR TO COMMENCEMENT OF EXCAVATION WORKS INCLUDING LOCATE AND MARKING SERVICE

email [cbyd@openreach.co.uk](mailto:cbyd@openreach.co.uk)

ADVANCE NOTICE REQUIRED  
(Office hours: Monday - Friday 08.00 to 17.00)  
[www.openreach.co.uk/cbyd](http://www.openreach.co.uk/cbyd)

### Accidents happen

If you do damage any Openreach equipment please let us know by calling 0800 023 2023 (opt 1 + opt 1) and we can get it fixed ASAP

KEY TO BT SYMBOLS		Change Of State	+	Hatchings		
	<i>Planned</i>	<i>Live</i>	Split Coupling	×	Built	
PCP			Duct Tee	▲	Planned	
Pole			Building		Inferred	
Box			Kiosk		Duct	
Manhole			Other proposed plant is shown using dashed lines. BT Symbols not listed above may be disregarded. Existing BT Plant may not be recorded. Information valid at time of preparation. Maps are only valid for 90 days after the date of publication.			
Cabinet						
	<i>Pending Add</i>	<i>In Place</i>	<i>Pending Remove</i>	<i>Not In Use</i>		
Power Cable						
Power Duct				N/A		

Reproduced from the Ordnance Survey map by BT by permission of Ordnance Survey on behalf of the Controller of Her Majesty's Stationary Office

(C) Crown Copyright British Telecommunications plc 100028040

BT Ref : RRD12554R

Map Reference : (centre) SN6514301120

Easting/Northing : (centre) 265143,201120

Issued : 05/12/2022 12:55:55

**WARNING: IF PLANNED WORKS FALL INSIDE HATCHED AREA IT IS ESSENTIAL BEFORE PROCEEDING THAT YOU CONTACT THE NATIONAL NOTICE HANDLING CENTRE. PLEASE SEND E-MAIL TO: [nnhc@openreach.co.uk](mailto:nnhc@openreach.co.uk)**

# Maps by email Plant Information Reply



## IMPORTANT WARNING

Information regarding the location of BT apparatus is given for your assistance and is intended for general guidance only. No guarantee is given of its accuracy. It should not be relied upon in the event of excavations or other works being made near to BT apparatus which may exist at various depths and may deviate from the marked route.



**openreach**

### CLICK BEFORE YOU DIG

FOR PROFESSIONAL FREE ON SITE ASSISTANCE PRIOR TO COMMENCEMENT OF EXCAVATION WORKS INCLUDING LOCATE AND MARKING SERVICE

email [cbyd@openreach.co.uk](mailto:cbyd@openreach.co.uk)

ADVANCE NOTICE REQUIRED  
(Office hours: Monday - Friday 08.00 to 17.00)  
[www.openreach.co.uk/cbyd](http://www.openreach.co.uk/cbyd)

### Accidents happen

If you do damage any Openreach equipment please let us know by calling 0800 023 2023 (opt 1 + opt 1) and we can get it fixed ASAP

## KEY TO BT SYMBOLS

		Change Of State	+	Hatchings	
	<i>Planned</i>	<i>Live</i>	Split Coupling	×	Built
PCP			Duct Tee	▲	Planned
Pole			Building		Inferred
Box			Kiosk		Duct
Manhole			Other proposed plant is shown using dashed lines. BT Symbols not listed above may be disregarded. Existing BT Plant may not be recorded. Information valid at time of preparation. Maps are only valid for 90 days after the date of publication.		
Cabinet					
	<i>Pending Add</i>	<i>In Place</i>	<i>Pending Remove</i>	<i>Not In Use</i>	
Power Cable					
Power Duct				N/A	

Reproduced from the Ordnance Survey map by BT by permission of Ordnance Survey on behalf of the Controller of Her Majesty's Stationary Office

(C) Crown Copyright British Telecommunications plc 100028040

BT Ref : BAK12551C

Map Reference : (centre) SN6560801120

Easting/Northing : (centre) 265608,201120

Issued : 05/12/2022 12:55:58

**WARNING: IF PLANNED WORKS FALL INSIDE HATCHED AREA IT IS ESSENTIAL BEFORE PROCEEDING THAT YOU CONTACT THE NATIONAL NOTICE HANDLING CENTRE. PLEASE SEND E-MAIL TO: [nnhc@openreach.co.uk](mailto:nnhc@openreach.co.uk)**

# Maps by email Plant Information Reply

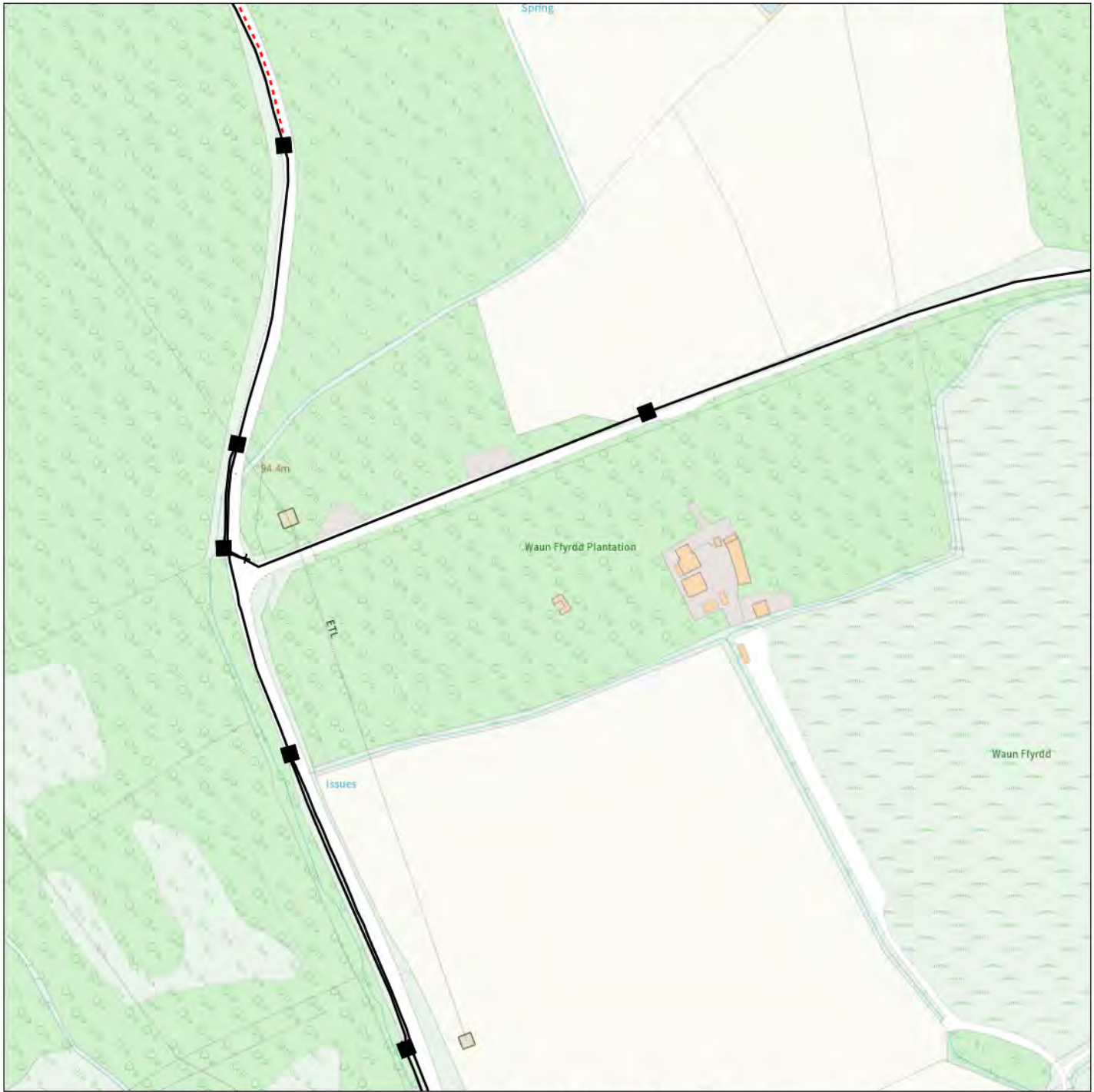

## IMPORTANT WARNING

Information regarding the location of BT apparatus is given for your assistance and is intended for general guidance only. No guarantee is given of its accuracy. It should not be relied upon in the event of excavations or other works being made near to BT apparatus which may exist at various depths and may deviate from the marked route.



**openreach**

### CLICK BEFORE YOU DIG

FOR PROFESSIONAL FREE ON SITE ASSISTANCE PRIOR TO COMMENCEMENT OF EXCAVATION WORKS INCLUDING LOCATE AND MARKING SERVICE

email [cbyd@openreach.co.uk](mailto:cbyd@openreach.co.uk)

ADVANCE NOTICE REQUIRED  
(Office hours: Monday - Friday 08.00 to 17.00)  
[www.openreach.co.uk/cbyd](http://www.openreach.co.uk/cbyd)

### Accidents happen

If you do damage any Openreach equipment please let us know by calling 0800 023 2023 (opt 1 + opt 1) and we can get it fixed ASAP

KEY TO BT SYMBOLS		Change Of State	+	Hatchings		
	<i>Planned</i>	<i>Live</i>	Split Coupling	×	Built	
PCP			Duct Tee	▲	Planned	
Pole			Building		Inferred	
Box			Kiosk		Duct	
Manhole			Other proposed plant is shown using dashed lines. BT Symbols not listed above may be disregarded. Existing BT Plant may not be recorded. Information valid at time of preparation. Maps are only valid for 90 days after the date of publication.			
Cabinet						
	<i>Pending Add</i>	<i>In Place</i>	<i>Pending Remove</i>	<i>Not In Use</i>		
Power Cable						
Power Duct				N/A		

Reproduced from the Ordnance Survey map by BT by permission of Ordnance Survey on behalf of the Controller of Her Majesty's Stationary Office

(C) Crown Copyright British Telecommunications plc 100028040

BT Ref : LEO12555R

Map Reference : (centre) SN6421400656

Easting/Northing : (centre) 264214,200656

Issued : 05/12/2022 12:56:02

**WARNING: IF PLANNED WORKS FALL INSIDE HATCHED AREA IT IS ESSENTIAL BEFORE PROCEEDING THAT YOU CONTACT THE NATIONAL NOTICE HANDLING CENTRE. PLEASE SEND E-MAIL TO: [nnhc@openreach.co.uk](mailto:nnhc@openreach.co.uk)**

# Maps by email Plant Information Reply



## IMPORTANT WARNING

Information regarding the location of BT apparatus is given for your assistance and is intended for general guidance only. No guarantee is given of its accuracy. It should not be relied upon in the event of excavations or other works being made near to BT apparatus which may exist at various depths and may deviate from the marked route.



**openreach**

### CLICK BEFORE YOU DIG

FOR PROFESSIONAL FREE ON SITE ASSISTANCE PRIOR TO COMMENCEMENT OF EXCAVATION WORKS INCLUDING LOCATE AND MARKING SERVICE

email [cbyd@openreach.co.uk](mailto:cbyd@openreach.co.uk)

ADVANCE NOTICE REQUIRED  
(Office hours: Monday - Friday 08.00 to 17.00)  
[www.openreach.co.uk/cbyd](http://www.openreach.co.uk/cbyd)

### Accidents happen

If you do damage any Openreach equipment please let us know by calling 0800 023 2023 (opt 1 + opt 1) and we can get it fixed ASAP

KEY TO BT SYMBOLS		Change Of State	+	Hatchings		
	<i>Planned</i>	<i>Live</i>	Split Coupling	×	Built	
PCP			Duct Tee	▲	Planned	
Pole			Building		Inferred	
Box			Kiosk		Duct	
Manhole			Other proposed plant is shown using dashed lines. BT Symbols not listed above may be disregarded. Existing BT Plant may not be recorded. Information valid at time of preparation. Maps are only valid for 90 days after the date of publication.			
Cabinet						
	<i>Pending Add</i>	<i>In Place</i>	<i>Pending Remove</i>	<i>Not In Use</i>		
Power Cable						
Power Duct				N/A		

Reproduced from the Ordnance Survey map by BT by permission of Ordnance Survey on behalf of the Controller of Her Majesty's Stationary Office

(C) Crown Copyright British Telecommunications plc 100028040

BT Ref : GUL12554V

Map Reference : (centre) SN6467800656

Easting/Northing : (centre) 264678,200656

Issued : 05/12/2022 12:56:09

**WARNING: IF PLANNED WORKS FALL INSIDE HATCHED AREA IT IS ESSENTIAL BEFORE PROCEEDING THAT YOU CONTACT THE NATIONAL NOTICE HANDLING CENTRE. PLEASE SEND E-MAIL TO: [nnhc@openreach.co.uk](mailto:nnhc@openreach.co.uk)**

# Maps by email Plant Information Reply



## IMPORTANT WARNING

Information regarding the location of BT apparatus is given for your assistance and is intended for general guidance only. No guarantee is given of its accuracy. It should not be relied upon in the event of excavations or other works being made near to BT apparatus which may exist at various depths and may deviate from the marked route.



**openreach**

### CLICK BEFORE YOU DIG

FOR PROFESSIONAL FREE ON SITE ASSISTANCE PRIOR TO COMMENCEMENT OF EXCAVATION WORKS INCLUDING LOCATE AND MARKING SERVICE

email [cbyd@openreach.co.uk](mailto:cbyd@openreach.co.uk)

ADVANCE NOTICE REQUIRED  
(Office hours: Monday - Friday 08.00 to 17.00)  
[www.openreach.co.uk/cbyd](http://www.openreach.co.uk/cbyd)

### Accidents happen

If you do damage any Openreach equipment please let us know by calling 0800 023 2023 (opt 1 + opt 1) and we can get it fixed ASAP

KEY TO BT SYMBOLS		Change Of State	+	Hatchings		
	<i>Planned</i>	<i>Live</i>	Split Coupling	×	Built	
PCP			Duct Tee	▲	Planned	
Pole			Building		Inferred	
Box			Kiosk		Duct	
Manhole			Other proposed plant is shown using dashed lines. BT Symbols not listed above may be disregarded. Existing BT Plant may not be recorded. Information valid at time of preparation. Maps are only valid for 90 days after the date of publication.			
Cabinet						
	<i>Pending Add</i>	<i>In Place</i>	<i>Pending Remove</i>	<i>Not In Use</i>		
Power Cable						
Power Duct				N/A		

Reproduced from the Ordnance Survey map by BT by permission of Ordnance Survey on behalf of the Controller of Her Majesty's Stationary Office

(C) Crown Copyright British Telecommunications plc 100028040

BT Ref : XGW12568B

Map Reference : (centre) SN6514300656

Easting/Northing : (centre) 265143,200656

Issued : 05/12/2022 12:56:12

**WARNING: IF PLANNED WORKS FALL INSIDE HATCHED AREA IT IS ESSENTIAL BEFORE PROCEEDING THAT YOU CONTACT THE NATIONAL NOTICE HANDLING CENTRE. PLEASE SEND E-MAIL TO: [nnhc@openreach.co.uk](mailto:nnhc@openreach.co.uk)**



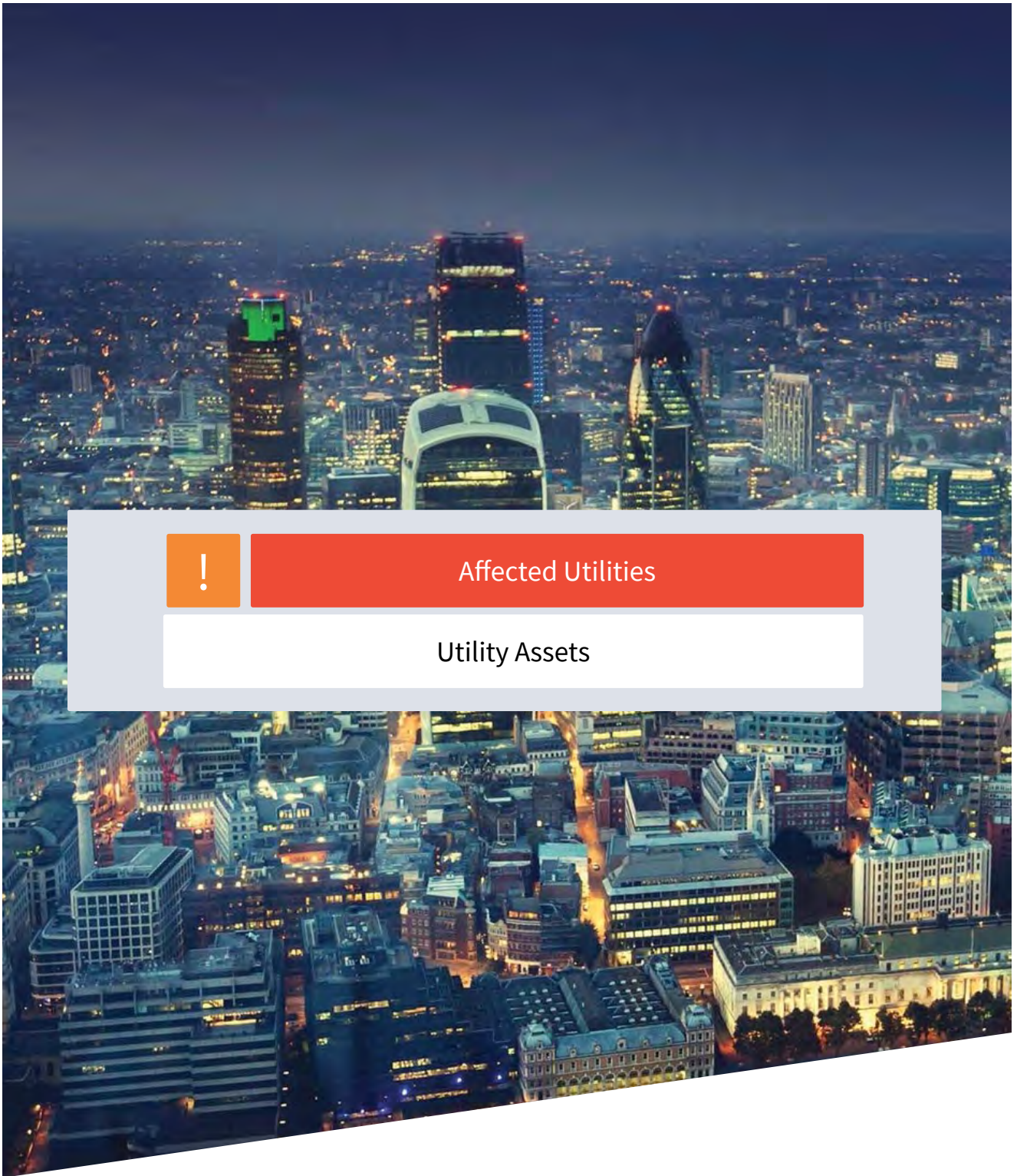

Affected Utilities

Utility Assets

## ADVISORY NOTICE

### SUPPLIER UPDATE: Utility Assets

On 02/12/2022, an enquiry was sent to Utility Assets' plant record department. As of the date of issue of this Utilities Report, we have not received a formal response from Utility Assets in regards to owning any equipment on this site. Utility Assets have however advised the following:

*"Thank you for recently contacting Utility Assets plant record department. We will check whether we have any plant present at your site and contact you within 5 - 7 working days ONLY if we own any plant in the vicinity.*

*If we do not reply, we do not have any apparatus in the area of your works. However, PLEASE TAKE CARE when excavating around electricity cables in the event that not all cables present may be accurately shown. We recommend you use detecting equipment to map the site before excavating and fully comply with HSG47. DO NOT assume that a cable is dead if you don't have a record of its presence. The cable must be treated as live unless PROVEN DEAD by the cable owner. In case of emergency please contact your local electricity distribution company.*

*This is an automated reply from our dedicated asset records email address. If you receive further correspondence from us it will be from [asset.manager@utilityassets.co.uk](mailto:asset.manager@utilityassets.co.uk) quoting a site reference number.*

*Asset Manager - Utility Assets Ltd"*

If a formal response is received within 3 months of the date of this search it will be forwarded onto you as per our usual service. However, without formal communication from Utility Assets it remains unconfirmed that your site will not be affected by their network. Utility Assets will not acknowledge receipt of this enquiry, or any subsequent chases, unless their network will be affected.

## Terms and Conditions

Full Terms and Conditions can be found on the following URL:  
<http://www.landmarkinfo.co.uk/Terms/Show/515>

Please note that Utilities Reports have a validity of 3 months from the date of purchase.

If you experience difficulties accessing our Terms and Conditions, please telephone our Customer Service Team on 0844 844 9966.

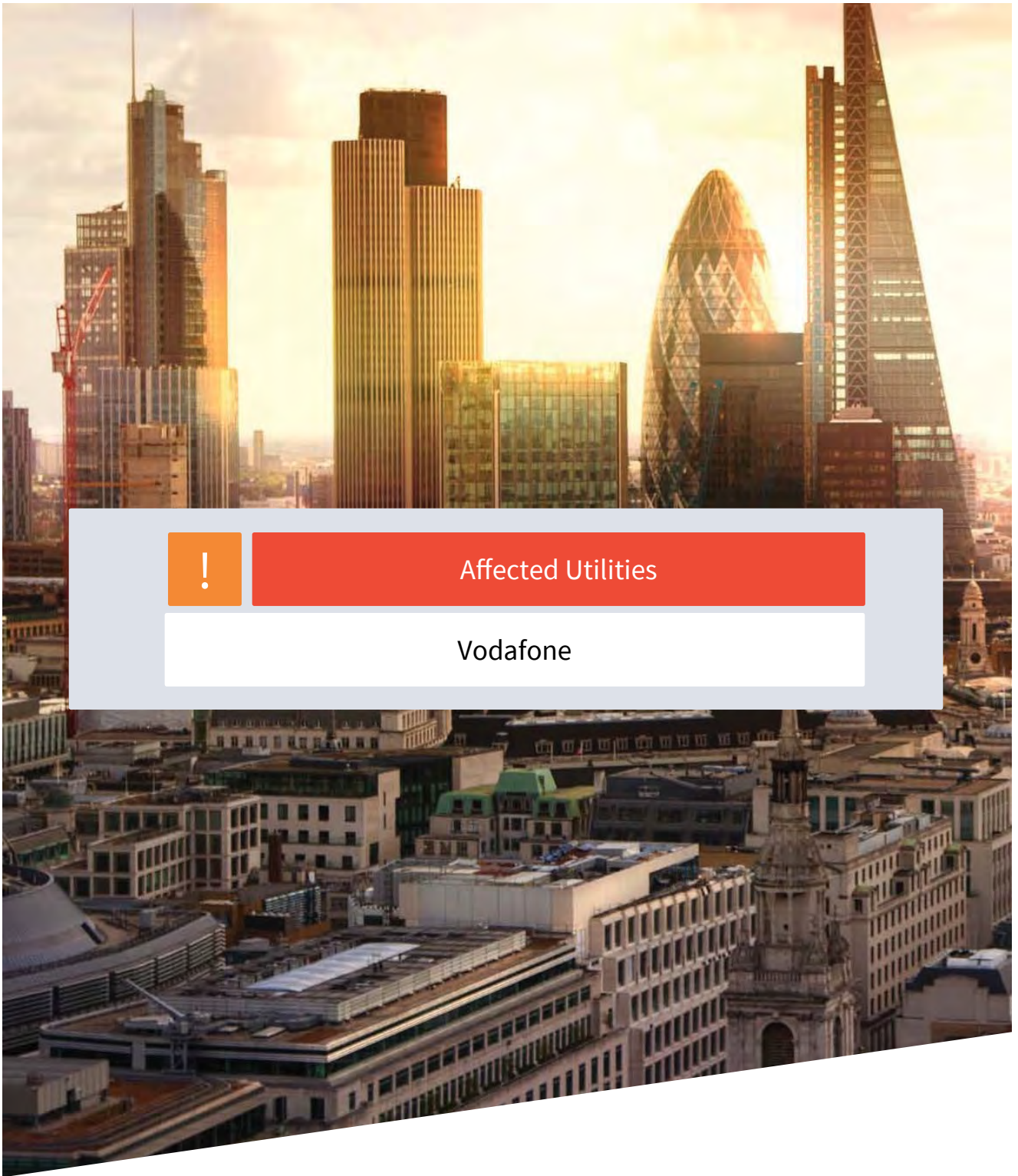

Affected Utilities

Vodafone

**CHECKED**

**From:** National Plant Enquiries  
**Sent:** 05 December 2022 16:53  
**To:** Utility Solutions GDC Requests  
**Subject:** RE: Plant Enquiry - 115410 - Site near Rhydypany Road, Felindre, Swansea - Please respond by 06/12/2022  
**Attachments:** 115410.pdf; Vodafone External Apparatus Special Requirements v3.pdf

**Note:** Only affected parts are printed and our network is not present in the remaining areas of your proposed works.

Please note that according to our records there is leased and/or third party network within your proposed works. However, because the plant is leased/third party we strongly recommend you contact all other utility providers to gather the extent of services within that area. Unfortunately, we are unable to advise who the plant is leased to or who the third party is.

**IMPORTANT - PLEASE READ = Your Next Step?:-**

Where apparatus is affected and requires diversion, please send all the scheme related proposals that affects the Vodafone Network to [c3requests@vodafone.com](mailto:c3requests@vodafone.com) with a request for a 'C3 Budget Estimate'. Please ensure you include a plan showing proposed works. (A location plan is insufficient for Vodafone to provide a costing). These estimates will be provided by Vodafone directly, normally within 20 working days from receipt of your request. Please include proof of this C2 response when requesting a C3 (using the 'forward' option). Diversionary works may be necessary if the existing line of the highway/railway or its levels are altered.

**If you require a quote for new development, commercial site connections - please email your requirements and associated plans to [c3requests@vodafone.com](mailto:c3requests@vodafone.com) and a budget estimate will be returned, within 10 working days of receipt**

Plant Enquiries Team(nh)  
T: +44 (0)1454 662881  
E: [osm.enquiries@atkinsglobal.com](mailto:osm.enquiries@atkinsglobal.com)

This response is made only in respect to electronic communications apparatus forming part of the Vodafone Limited electronic communications network formerly being part of the electronic communications networks of Cable & Wireless UK, Energis Communications Limited, Thus Group Holdings Plc and Your Communications Limited.

ATKINS working on behalf of Vodafone: Fixed



**PLEASE NOTE:**

The information given is indicative only. No warranty is made as to its accuracy. This information must not be solely relied upon in the event of excavation or other works carried out in the vicinity of Vodafone plant. No liability of any kind whatsoever is accepted by Vodafone, its servants, or agents, for any error or omission in respect of information contained on this information. The actual position of underground services must be verified and established on site before any mechanical plant is used. Authorities and contractors will be held liable for the full cost of repairs to Vodafone's apparatus and all claims made against them by Third parties as a result of any interference or damage.



Please consider the environment before printing this e-mail

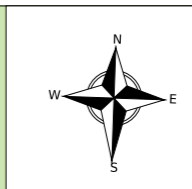

Some of the material in this plan has been reproduced from an Ordnance Survey map with the permission of The Controller of Her Majesty's Stationary Office, © Crown Copyright Ordnance Copyright & Ordnance Survey G License 100031653

### Legend

- Access Chamber.Location Active Carriageway Chamber
- Underground Route.Route Active - Third Party



Vodafone Limited (No01471587) registered office is at Vodafone House, The Connection, Newbury, Berkshire, RG142FN

Plot Date : 05/12/2022	Scale : 1:1250
------------------------	----------------

This plan shows apparatus owned by members of the Vodafone Group of companies (including legacy telecommunication companies currently within the group)

Information with regard to such apparatus should always be obtained from Vodafone or its appointed agents.



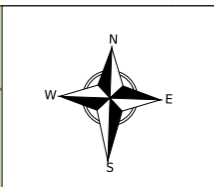
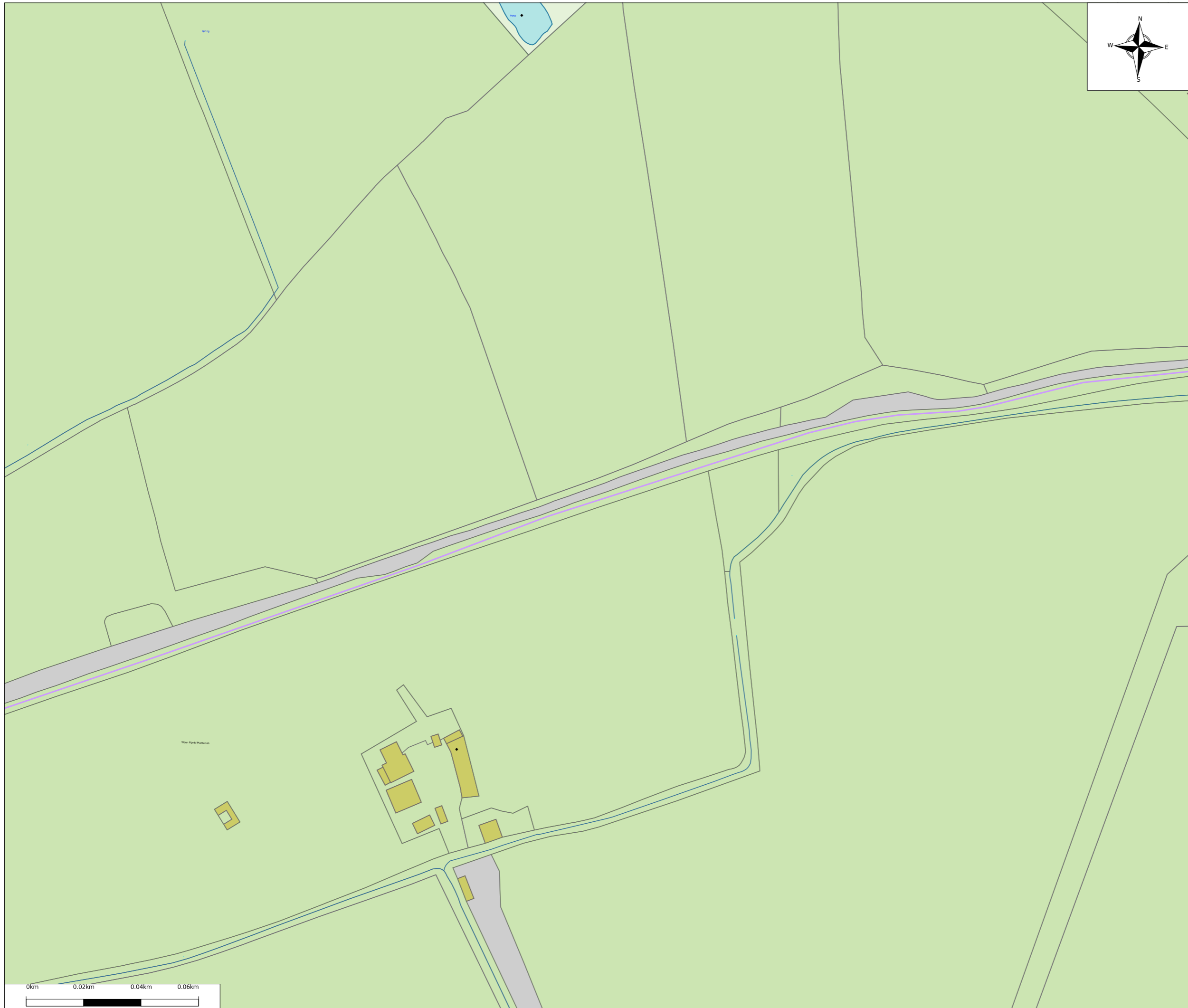

Some of the material in this plan has been reproduced from an Ordnance Survey map with the permission of The Controller of Her Majesty's Stationary Office, © Crown Copyright Ordnance Copyright & Ordnance Survey License 100031653

### Legend

— Underground Route.Route Active - Third Party



Vodafone Limited (No01471587) registered office is at Vodafone House, The Connection, Newbury, Berkshire, RG142FN

Plot Date : 05/12/2022	Scale : 1:1250
------------------------	----------------

This plan shows apparatus owned by members of the Vodafone Group of companies (including legacy telecommunication companies currently within the group)

Information with regard to such apparatus should always be obtained from Vodafone or its appointed agents.



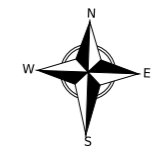
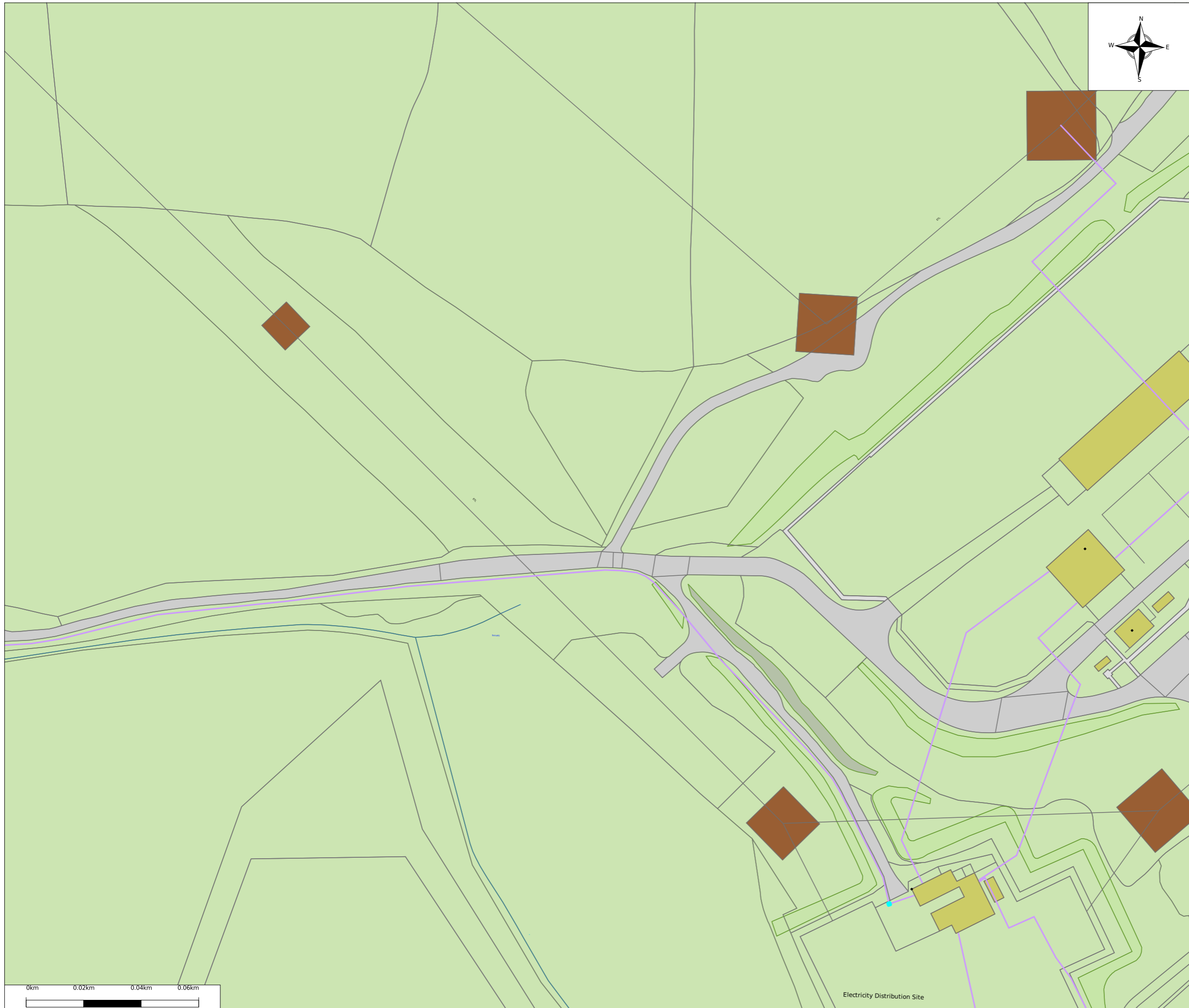

Some of the material in this plan has been reproduced from an Ordnance Survey map with the permission of The Controller of Her Majesty's Stationary Office, © Crown Copyright Ordnance Copyright & Ordnance Survey License 100031653

### Legend

- Access Chamber.Location Active Carriageway Chamber
- Underground Route.Route Active - Third Party



Vodafone Limited (No01471587) registered office is at Vodafone House, The Connection, Newbury, Berkshire, RG142FN

Plot Date : 05/12/2022    Scale : 1:1250

This plan shows apparatus owned by members of the Vodafone Group of companies (including legacy telecommunication companies currently within the group)

Information with regard to such apparatus should always be obtained from Vodafone or its appointed agents.

0km    0.02km    0.04km    0.06km



Electricity Distribution Site

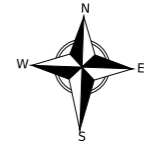

Some of the material in this plan has been reproduced from an Ordnance Survey map with the permission of The Controller of Her Majesty's Stationary Office, © Crown Copyright Ordnance Copyright & Ordnance Survey G License 100031653

### Legend

- Access Chamber.Location Active Carriageway Chamber
- Underground Route.Route Active - Third Party



Vodafone Limited (No01471587) registered office is at Vodafone House, The Connection, Newbury, Berkshire, RG142FN

Plot Date : 05/12/2022      Scale : 1:1250

This plan shows apparatus owned by members of the Vodafone Group of companies (including legacy telecommunication companies currently within the group)

Information with regard to such apparatus should always be obtained from Vodafone or its appointed agents.

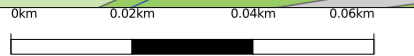





# Special Requirements relating to the External Plant Network of Vodafone

## Contents

1.	Introduction.....	1
2.	Purpose of document.....	1
3.	Scope.....	2
4.	Vodafone Network and Apparatus .....	2
5.	Plant records.....	2
6.	Definitions.....	2
7.	Requirements.....	3
8.	Depths of cover.....	3
9.	Separation .....	4
10.	Jointing chambers.....	5
11.	Notification periods .....	5
12.	Excavation and backfill.....	5
13.	Foam concrete .....	6
14.	Attendance of Company Representative.....	6
15.	Damage reports.....	6
16.	Appendix A – Street Works Team Contacts for Vodafone.....	7
17.	Appendix B – What constitutes Vodafone Network .....	8
18.	About this Document.....	13

## 1. Introduction

This document sets out the procedure that will apply when Other Parties intend or are undertaking works in the vicinity of Vodafone apparatus (see Appendix B for further information on what constitutes Vodafone apparatus).

## 2. Purpose of document

This document provides a means by which the Vodafone specific special requirements relating to their apparatus, regardless of it being situated in the public highway / road, private street, land or any other areas, is made aware to Other Parties.



### 3. Scope

This document will be presented to Other Parties or Contractors to encourage those undertaking works within the vicinity of Vodafone apparatus to refer to and comply with. This is in order to protect where necessary the Vodafone apparatus and to avoid damage to the apparatus and loss of service.

A National Joint Utilities Group (NJUG) document NJUG Volume 3 Guidelines on the Management of Third Party Cable Ducting provides useful reference material.

It should be noted that, where appropriate, additional information on avoiding danger from underground apparatus is contained within the HSG47 guidance book titled "Avoiding Danger from Underground Services."

### 4. Vodafone Network and Apparatus

Damage to Vodafone apparatus is extremely disruptive and can be expensive to repair, especially where long lengths of cable have to be replaced.

In order to maintain the network integrity and minimise disruption to service, it is essential that disturbances are absolutely minimal. When working within the vicinity of Vodafone apparatus, extreme care is necessary in order to avoid costly repairs. The Other Parties / Contractor shall make every effort to ensure that disturbance of Vodafone apparatus is no more than is absolutely necessary for the completion of the works in accordance with their contract. It should be noted that it is an offence to interfere with Vodafone apparatus without first contacting the company for advice.

### 5. Plant records

It is the responsibility of the Other Parties undertaking works which may affect Vodafone apparatus to obtain all relevant Vodafone plant records from our agent Atkins Global prior to works commencing. This may be done by contacting the Atkins Global Plant Enquiries Team listed in Appendix B.

Plant records for such enquiries will generally be provided within 10 working days of receipt and in compliance with the New Roads and Street Works Act 1991 [NRSWA] requirements.

### 6. Definitions

The following definitions are applicable in this document:

- a) **Apparatus** - means all surface or sub-surface equipment and plant used by Vodafone including any associated cables or ducts owned, leased or rented by Vodafone.
- b) **Cable** - means any polythene or other sheath containing optical fibres or metallic conductors.
- c) **Depth of cover** - means the depth from the surface to the topmost barrel of the duct nest, in the case of ducts encased in concrete, to the top of the concrete, and in the case of directly buried cable, the top of the cable.
- d) **Jointing chamber** - means any manhole, surface box or other chamber giving access to Vodafone apparatus or their network.
- e) **Utility** - means an organisation licensed to provide gas, water, electricity, Cable TV or telecommunications services.
- f) **Developer** - means an organisation licensed to develop industrial/residential premises or given license to connect to utility apparatus.



- g) **Contractor** - means the individual, firm or company contracted to undertake the work for a Utility or Other Parties.
- h) **Other Parties** - means the Utilities, Highway or Roads Authorities, Developers, Street/Roads Authority Section 50/109 licensees
- i) **Site** - means the location of, or in the vicinity of, the various works.

## 7. Requirements

Prior to commencing any work or moving heavy plant or equipment over any portion of the site, the Other Parties or Contractor shall notify Vodafone of their intentions. This may be done by contacting Vodafone via the contact list in Appendix B.

Upon receipt of this notification, Vodafone will identify if their apparatus is affected. If any Vodafone apparatus is affected by the works then they will arrange for the necessary records to be provided and confirm details of Vodafone apparatus and network operated within the affected area or adjacent to the proposed work site.

### 7.1 Location of Plant

It is the responsibility of the Other Parties or Contractors to undertake adequate plant location procedures. These may include searches for metallic cables which must be performed by actively inducing a signal in a cable conductor via a transmitter. A passive search is not considered sufficient.

Before applying a tracing signal to the Vodafone apparatus, the Other Parties or Contractors shall seek confirmation from Atkins Global that the Vodafone apparatus will not suffer any disruption to its networks normal workings as a result of the nature of the signal being induced.

### 7.2 Trial excavations

Optic fibre cables are very susceptible to damage from excavation tools. They are not electrically conductive and cannot be located by radio induction methods. Once an approximate location is known, the exact location must be ascertained by means of hand dug pilot holes. Where the work to be carried out by the Other Party or Contractor involves excavation in the vicinity of our apparatus, the Other Party or Contractor shall, by trial excavation at his own expense, determine the exact location and depth of the Vodafone apparatus. All excavations adjacent to the Vodafone apparatus are to be carried out by hand until the extent and /or location of the apparatus is known.

**All excavation work shall be executed in accordance with the current issue of Health and Safety series booklet HSG47, Avoiding danger from underground services.**

## 8. Depths of cover

The Other Party or Contractor should note that the minimum depths of cover for Vodafone apparatus shall be maintained together with specified separation requirements. Where the minimum depths of cover specified by Vodafone cannot be maintained, the Other Party or Contractor shall at their own expense, carry out the instructions of Vodafone requirements for the protection or diversion of their apparatus.

**The Other Party or Contractor should have particular regard to the possibility of encountering Vodafone apparatus (including ducts and cables), at depths of cover other than that reported.**

Surface cables (such as cables on bridges or walls) which are liable to be placed in danger from the Other Parties or Contractors works shall be protected, at the Other Parties expense, as directed by the Vodafone representative.



## 9. Separation

Reference should be made to HSG47 to ensure that adequate separation is achieved. The following details outline the specific requirements of Vodafone and capture the HSG47 requirements.

### 9.1 High voltage cables

High voltage single core cables of 1000 V and above shall have a minimum clearance from Company Apparatus of 500 mm.

High voltage multi-core cables of 1000 V and above shall have a minimum clearance from Company Apparatus of 350 mm.

In exceptional circumstances where the above clearances cannot be maintained, the separating distance may be reduced to a minimum of 175 mm. In such circumstances, concrete, of a quality as directed by the Company Representative, must be inserted to completely fill the space between the High Voltage cable and the Company Apparatus, in accordance with the requirements of the Company Representative. Any further services must have a minimum clearance of 250 mm from the concrete.

### 9.2 Low voltage cables

Low voltage cables of less than 1000 V shall have a minimum clearance from Company Apparatus of 180 mm. In exceptional circumstances where the above clearance cannot be maintained, the separating distance may be reduced to a minimum of 75 mm. In such circumstances, concrete, of a quality as directed by the Company Representative, must be inserted to completely fill the space between the services, in accordance with the requirements of the Company Representative. Any further services must have a minimum clearance of 250 mm from the concrete.

### 9.3 Ancillary electrical apparatus

Street furniture such as lamp posts, traffic posts and other such ancillary electrical apparatus shall have a minimum clearance of 150 mm from underground Company Apparatus and 600mm clearance from above ground Company Apparatus.

### 9.4 High pressure gas mains and other Undertakers plant/equipment

High pressure gas mains shall have a minimum clearance of 450 mm from Company Apparatus. All other undertakers' plant and equipment, when running in parallel with Company Apparatus, shall have a minimum clearance of 200mm. Where gas mains cross Company Apparatus, the minimum clearance shall be 200mm. All other undertakers' plant and equipment, when running across Company Apparatus, shall have a minimum clearance of 100 mm. NJUG Volume 1, Guidelines on the positioning and colour coding of underground utilities' apparatus refers.

### 9.5 Other Undertakers plant

Other undertakers' plant and equipment which runs in parallel with Company Apparatus shall have a minimum clearance of 200mm. All other undertakers' plant and equipment when running across Company Apparatus shall have a minimum clearance of 100mm.

### 9.6 Tramways

Each separating distance shall be individually agreed with the Company Representative.



## 10. Jointing chambers

### 10.1 Protection

Footway type jointing chambers are not designed to withstand carriageway loadings.

Where such chambers are liable to be placed at risk, either temporarily or permanently, from vehicular traffic or from the movement of plant and/or equipment, they will need to be adequately protected. Alternatively, they may have to be demolished and rebuilt to carriageway standards, at the Other Parties or Contractors expense under supervision of Vodafone representative.

All Vodafone jointing chambers and / or other access points shall be kept clear and unobstructed. Access for vehicles, winches, cable drums and / or any further equipment required by Vodafone for the maintenance of its apparatus, must be maintained at all reasonable times.

### 10.2 Access

The covers to Vodafone jointing chambers and / or apparatus shall only be lifted by means of the appropriate keys and under the direct supervision of a Vodafone representative. Other Parties or Contractors shall not enter any Vodafone jointing chamber and / or apparatus unless under the supervision of a Vodafone representative and in any case not before the mandatory gas test has been carried out in the presence of Vodafone representative and such checks have shown it to be safe to enter the Vodafone chamber and / or apparatus. The Other Parties or Contractors shall be given reasonable access to Vodafone apparatus and chambers when required.

## 11. Notification periods

Where the Other Parties or Contractors works or the movement of plant or equipment may endanger Vodafone apparatus, the Other Party or Contractor shall give **Vodafone at least 7 working days' notice in writing** of the intended date to commence operations.

No excavation should be made without first consulting the relevant Vodafone apparatus layout drawings, which will be made available from the Vodafone agent Atkins Global on request and allowing 28 working days for processing the relevant drawings. However, should this not be possible, direct contact should be made to the Atkins Global Plant Enquiries Team as soon as possible to assess the situation.

When excavating, moving or backfilling (including use of Foamed Concrete for Reinstatements – FCR) around Vodafone apparatus, **Vodafone shall be given adequate prior written notice of the Other Parties or Contractors intentions, in order that the works may be adequately supervised. Such notice shall not be less than 3 working days.**

## 12. Excavation and backfill

All excavations adjacent to Vodafone apparatus are to be carried out by hand until the extent and or location of the Vodafone apparatus is known.

Use of mechanical borers and / or excavators shall not be used without the supervisory presence of a Vodafone representative or a given exemption.

Shuttering of the excavation or support to Vodafone apparatus, at the Other Parties or Contractors expense, shall be used as directed by the Vodafone representative.

At least 7 working days' notice must be given to Vodafone in order that any special protective measures which may be required to protect Vodafone apparatus, at the Other Parties or Contractors expense, when equipment such as pile driving, explosives, laser cutting high powered RF equipment or RF test gear, is to be used in conjunction with the works.



Other Parties or Contractors are advised to refer to the National Joint Utilities Group publication: NJUG Volume 1- Guidelines on the Positioning and Colour Coding of Underground Utilities' Apparatus

## 13. Foam concrete

If foam concrete is being used as the backfill material, it shall not be used either above or within 500 mm of any Company Apparatus. A suitable material in accordance with the specification for the Reinstatement of Openings in Highways shall be substituted.

## 14. Attendance of Company Representative

If a situation requires the attendance on site of a Vodafone representative for a continuous period of more than 6 hours, suitable facilities shall be provided by the Other Party or Contractor, at their expense, to meet the office and ablution requirements. If a situation arises that requires urgent attention Vodafone will endeavour to attend site within 2 hours for all other occasions arising, 24 hours.

## 15. Damage reports

In the event of any damage whatsoever occurring to Vodafone apparatus, the Other Party or Contractor shall immediately inform Vodafone by contacting their 24/7 number , (for contact details please refer to Appendix A).

All relevant costs of any subsequent repair and / or removal of the Vodafone apparatus shall be charged to the Other Party or Contractor, irrespective of who affects the repair.

The above requirements do not relieve the Other Party or Contractor of any of their obligations under their contract.



## 16. Appendix A – Street Works Team Contacts for Vodafone

Function	Address	Phone	Email Address
Streetworks Team	Vodafone, Street Works, Faraday House, Ground Floor, The Connection, Newbury, RG14 2FN	0333 304 0759	<a href="mailto:utilitiescentre@vodafone.com">utilitiescentre@vodafone.com</a>
Customer Complaints	n/a	0333 304 0762	n/a
Liability Claims Or Damage to Vodafone Apparatus	Vodafone Damage Claims, 1-2 Berkeley Square, 99 Berkeley Street Glasgow G3 7HR	0333 304 1104	<a href="mailto:claims@vodafone.com">claims@vodafone.com</a>
Diversionary Works C2/C3	Atkins Global, PO Box 290, 500 Aztec West, Almondsbury, Bristol, BS32 4RZ.	01454 662881	<a href="mailto:osm.enquiries@atkinsglobal.com">osm.enquiries@atkinsglobal.com</a>
Diversionary Works C4 / Escalations Networks Manager	Vodafone, Diversionary Works, 1-2 Berkeley Square, 99 Berkeley Street Glasgow G3 7HR	0141 303 2855	<a href="mailto:c3requests@vodafone.com">c3requests@vodafone.com</a>
Emergencies 24 Hour – Defects & Faults	n/a	0333 304 0762	n/a
Vodafone Plant Enquiries includes: Cable & Wireless; Mercury Comms; Thus plc; Scottish Telecoms; Your Comms; Norweb Comms; Energis	Atkins Global PO Box 290 500 Aztec West, Almondsbury, Bristol, BS32 4RZ	01454 662881	<a href="mailto:osm.enquiries@atkinsglobal.com">osm.enquiries@atkinsglobal.com</a>



# 17. Appendix B – What constitutes Vodafone Network

Vodafone own fibre network dedicated to business and residential users of telecommunications and has an international cable network that provides connectivity to 153 countries, either directly or indirectly through partners, reaching across the Atlantic Ocean, through Europe and on to India and throughout Asia. Spanning approximately 500,000 km in length, including interests in more than 69 major global cable systems, our next-generation network improves the quality and performance of telecommunications services through our use of advance optical and IP transmission.

In the UK & Ireland Vodafone’s overall network includes the following legacy networks now owned through acquisitions or Company name changes.

Below are examples of what you could see on the streets and should be aware of:



Cable & Wireless became Cable & Wireless Worldwide in 2010







Mercury Communications – changed its name to Cable & Wireless in 1996



Energis – was acquired by Cable Wireless in 2005





Thus plc was acquired by Cable & Wireless in 2008



## Scottish Telecom

Scottish Telecom demerged from its parent company Scottish Power to become Thus plc in 2002





# your communications

Your Communications was integrated into Thus plc in 2006



## NORWEB COMMS

Norweb Communications became Your Communications in 2000



Our apparatus is installed in roads and streets of UK and Ireland, however in some places is undistinguishable from other operators' apparatus, for example in City Centres where high quality infill modular paving chamber covers are found; some with labels and some without.

See below as examples:





The apparatus shown here is now owned, maintained and still in operation by Vodafone and includes.

- Vodafone
- Cable & Wireless
- Mercury Communications
- Energis
- Thus plc
- Your Communications
- Norweb Communications
- Scottish Telecom

Please see the Contact Details in Appendix A for Plant Enquiries and help on site.

## 18. About this Document

### Content Owner

Chris Nesbitt

### Changes since last version

Reformatted using the current Vodafone template to include updated Contact Details .

End of Document



Affected Utilities

Wales and West Utilities

**Company Address**

Wales and West Utilities Ltd,  
Wales and West House,  
Spooner Close, Celtic,  
Springs, Coedkernew,  
Newport, NP10 8FZ

Our Ref: 27820377 LM 115410/DK

Monday, 05 December 2022

Ben Evans  
The Hub, 500 Park Avenue, Aztec West  
Almondsbury  
Bristol  
BS32 4RZ



Dear Ben Evans

Thank you for contacting us regarding Wales & West Utilities equipment at the above site.

I enclose an extract from our mains records of the area covered by your proposals together with a comprehensive list of General Conditions for your guidance. This information is given as a general guide and its accuracy cannot be guaranteed. Service pipes, valves, syphons, stub connections, etc., are not shown but their presence should be anticipated.

Where the Wales & West Utilities (WWU) plan includes a warning label about our higher pressure apparatus you must contact the WWU dig team for further guidance. If it is deemed that a site visit is required for this location we require a minimum of 10 days' notice to arrange a site visit for our engineers to give further guidance. Depending upon the nature of the works the site visit may be deemed chargeable.

No liability of any kind whatsoever is accepted by Wales and West Utilities (WWU), its agents or servants for any error or omission. Please note that all WWU equipment on site should be assumed to be LIVE until proven otherwise.

Safe digging practices, in accordance with HS(G)47, Avoiding Danger from underground services must be used to verify and establish the actual position of mains, pipes, services and other apparatus on site before any mechanical plant is used. It is your responsibility to ensure that this information is provided to all persons (either direct labour or contractors) working for you on or near gas apparatus. Safe working procedures should be defined and practiced.

Irrespective of whether the pipeline is directly affected by the proposed development I enclose for information our general requirements for working in the vicinity of gas pipelines operating above 2 barg (T/SP/SSW22). It is our strong recommendation in the interests of safety that these general requirements be adhered to.

There are minimum proximity distances for buildings from WWU mains depending on both the operating pressure and the material of the main. Advice should be sought from WWU prior to building works taking place to confirm these distances. For High Pressure pipelines you must seek further guidance from the HSE and Local Authority Planning team regarding their LUP distances regarding building proximities as these may be in addition to WWU proximity distances for a pipeline.

In the presence of our >2barg gas pipelines no excavations are to take place within 10m of the confirmed position of these mains without prior consultation with WWU.

WWU reserves its position completely to enforce the terms of any existing easement against the landowner, even if this results in any planning permission granted not being able to be fully implemented.

**Company Address**

Wales and West Utilities Ltd,  
Wales and West House,  
Spooner Close, Celtic,  
Springs, Coedkernew,  
Newport, NP10 8FZ

You must not build over any of our plant or enclose our apparatus.

Where diversions to WWU apparatus are needed to allow change to occur on site, the cost of these alterations may be charged to the persons responsible for the works.

If you have requested a new connection the WWU connections team will where necessary prepare detailed proposals and provide a quotation for any necessary alterations and/or development of our equipment on the site.

If you require advice in connection with your proposals please contact the relevant number below.

Yours sincerely,  
WWU Dig Team

**Gas Emergency Number:**

In an emergency call 0800 111 999, 24 hours a day.

**Mapping Enquiries:**

If you have an enquiry relating to this letter or the attached map plan, please contact us using the following information:

Telephone 02920 278912  
Email dig@wwutilities.co.uk

**General Enquiries:**

If you have a general enquiry, please call us on the following number  
All areas 0800 912 29 99

**LinesearchbeforeUdig:**

If you have an enquiry relating to the use of the LinesearchbeforeUdig website please contact LinesearchbeforeUdig using the following information:

Telephone 0845 437 7365  
Email enquiries@linesearchbeforeudig.co.uk  
Website www.linesearchbeforeudig.co.uk



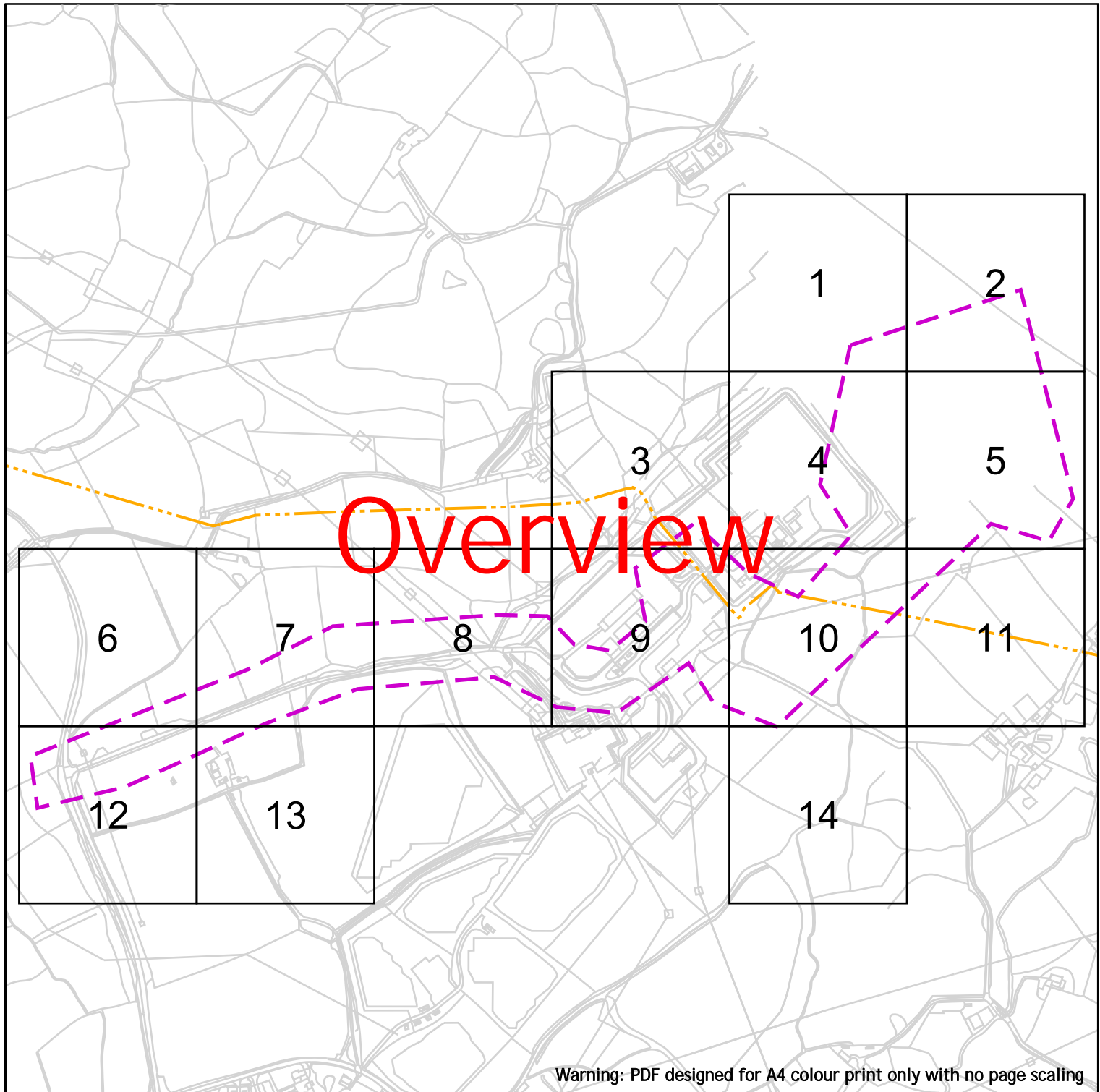

Warning: PDF designed for A4 colour print only with no page scaling



**Contact Us**  
**Mapping Enquiries:**  
 All areas 02920 278 912  
**General Enquiries:**  
 All areas 0800 912 2999

Dig Sites	Area:	Line:
	Low Pressure (LP) 21mbar – 75mbar	
	Medium Pressure (MP) 350mbar – 2bar	
	Intermediate Pressure (IP) 2bar – 7bar	
	High Pressure (HP) >7bar	

**EXTREME CAUTION.**  
 Major Accident Hazard Pipeline in Vicinity  
**\*\*RISK OF DEATH OR SERIOUS INJURY\*\***  
 Prior to excavation starting you must contact the plant protection team on 02920 278912

	Change of Diameter		Line/Fire Valve
	End Cap		Governor Station
	Depth of cover		

Date Requested: 05/12/2022  
 Job Reference: 27820377  
 Site Location: 265236 200946  
 Requested by: Mr Ben Evans  
 Your Scheme/Reference: LM 115410/DK

**IMPORTANT NOTICES**

- This information is given as a guide only and its accuracy cannot be guaranteed
- The plan only shows those pipes owned by Wales & West Utilities (WWU) as its role as a licensed Gas Transporter
- Service pipes, valves, syphons, stub connections etc. may not be shown but their presence should be anticipated
- You must use safe digging practices in accordance with HS(G)47 to establish the actual position of mains, services and other apparatus before any mechanical excavation is used
- It is your responsibility to ensure this information is provided to all persons working near our plant
- If in doubt call the WWU dig team on 02920 27891

**Report damage immediately – KEEP EVERYONE AWAY FROM THE AREA**  
**0800 111 999**

Smell gas?  
 Call the Gas Emergency Service on 0800 111 999.

**Dial before you dig**

Call 029 2027 8912 before you start work.

**Investigate**  
 Before you dig, make sure you know what's below.

**Go ahead**  
 Done your research? Now you can dig safely.

We need 10 days' notice

Scale: 1:7688 (When plotted at A4)

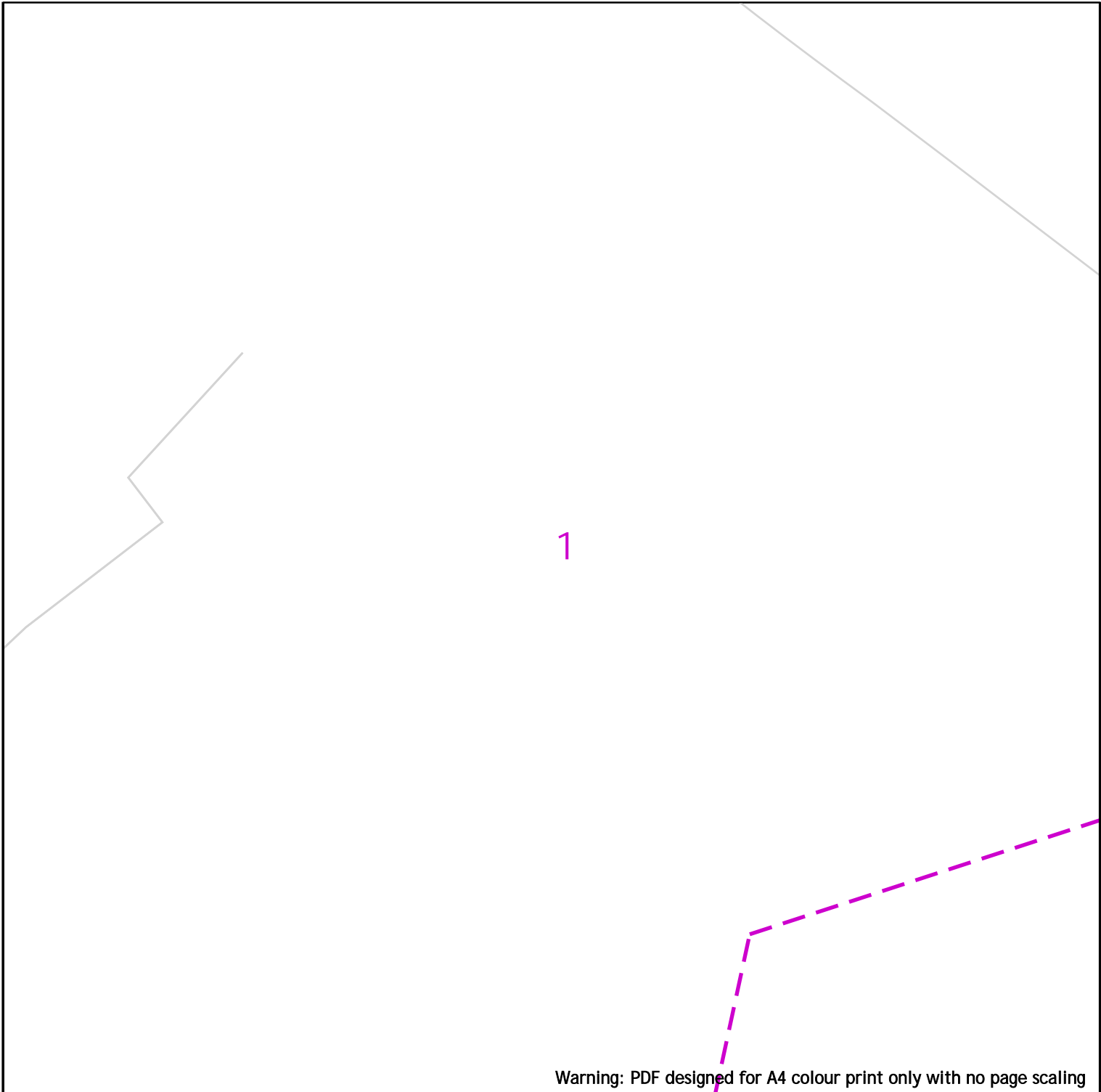

Warning: PDF designed for A4 colour print only with no page scaling



**Contact Us**  
**Mapping Enquiries:**  
 All areas 02920 278 912  
**General Enquiries:**  
 All areas 0800 912 2999

Date Requested: 05/12/2022  
 Job Reference: 27820377  
 Site Location: 265236 200946  
 Requested by: Mr Ben Evans  
 Your Scheme/Reference: LM  
 115410/DK  
 Scale: 1:1250 (When plotted at A4)

100m

Dig Sites	Area:	Line:
	Low Pressure (LP) 21mbar – 75mbar	
	Medium Pressure (MP) 350mbar – 2bar	
	Intermediate Pressure (IP) 2bar – 7bar	
	High Pressure (HP) >7bar	

	Change of Diameter		Line/Fire Valve
	End Cap		Governor Station
	Depth of cover		

**EXTREME CAUTION.**  
 Major Accident Hazard Pipeline in Vicinity  
**\*\*RISK OF DEATH OR SERIOUS INJURY\*\***  
 Prior to excavation starting you must contact the plant protection team on 02920 278912

**IMPORTANT NOTICES**

- This information is given as a guide only and its accuracy cannot be guaranteed
- The plan only shows those pipes owned by Wales & West Utilities (WWU) as its role as a licensed Gas Transporter
- Service pipes, valves, syphons, stub connections etc. may not be shown but their presence should be anticipated
- You must use safe digging practices in accordance with HS(G)47 to establish the actual position of mains, services and other apparatus before any mechanical excavation is used
- It is your responsibility to ensure this information is provided to all persons working near our plant
- If in doubt call the WWU dig team on 02920 27891

**Report damage immediately – KEEP EVERYONE AWAY FROM THE AREA**  
**0800 111 999**

Smell gas?  
 Call the Gas Emergency Service on  
**0800 111 999.**

**Dial before you dig**

We need 10 days' notice

Dial  
 Call **029 2027 8912** before you start work.

Investigate  
 Before you dig, make sure you know what's below.

Go ahead  
 Done your research? Now you can dig safely.

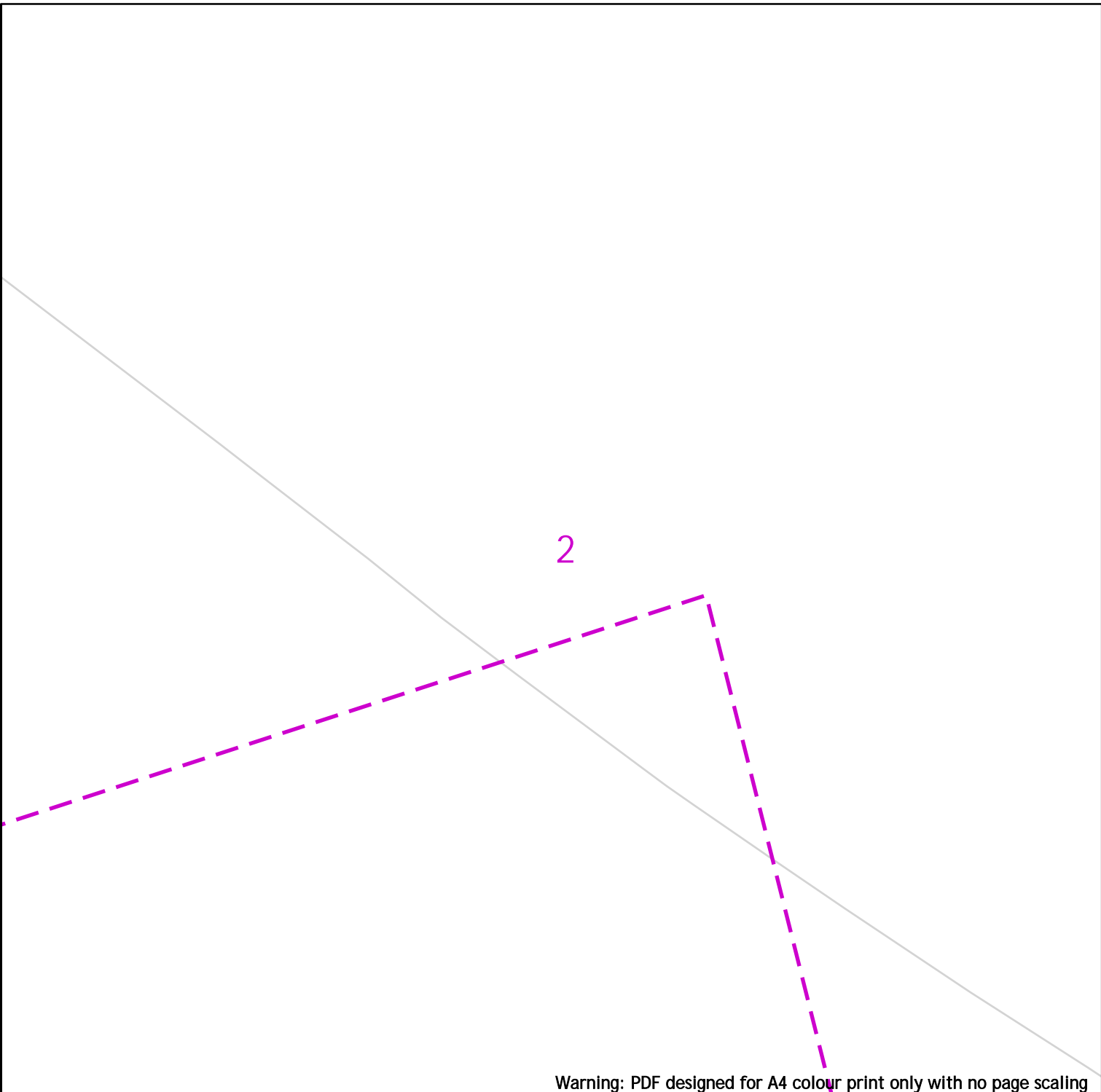

Warning: PDF designed for A4 colour print only with no page scaling

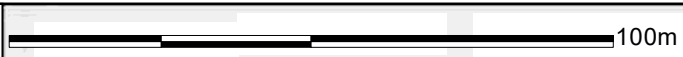

**EXTREME CAUTION.**  
Major Accident Hazard Pipeline in Vicinity  
**\*\*RISK OF DEATH OR SERIOUS INJURY\*\***  
Prior to excavation starting you must contact the plant protection team on 02920 278912

**Contact Us**  
**Mapping Enquiries:**  
All areas 02920 278 912  
**General Enquiries:**  
All areas 0800 912 2999

Dig Sites	Area:	Line:
	Low Pressure (LP) 21mbar – 75mbar	
	Medium Pressure (MP) 350mbar – 2bar	
	Intermediate Pressure (IP) 2bar – 7bar	
	High Pressure (HP) >7bar	

	Change of Diameter		Line/Fire Valve
	End Cap		Governor Station
	Depth of cover		

Date Requested: 05/12/2022  
Job Reference: 27820377  
Site Location: 265236 200946  
Requested by: Mr Ben Evans  
  
Your Scheme/Reference: LM 115410/DK  
  
Scale: 1:1250 (When plotted at A4)

**IMPORTANT NOTICES**

- This information is given as a guide only and its accuracy cannot be guaranteed
- The plan only shows those pipes owned by Wales & West Utilities (WWU) as its role as a licensed Gas Transporter
- Service pipes, valves, syphons, stub connections etc. may not be shown but their presence should be anticipated
- You must use safe digging practices in accordance with HS(G)47 to establish the actual position of mains, services and other apparatus before any mechanical excavation is used
- It is your responsibility to ensure this information is provided to all persons working near our plant
- If in doubt call the WWU dig team on 02920 27891

**Report damage immediately – KEEP EVERYONE AWAY FROM THE AREA**  
**0800 111 999**

Smell gas?  
Call the Gas Emergency Service on 0800 111 999.

**Dial before you dig**

We need 10 days' notice

Call 029 2027 8912 before you start work.

**Investigate**  
Before you dig, make sure you know what's below.

**Go ahead**  
Done your research? Now you can dig safely.

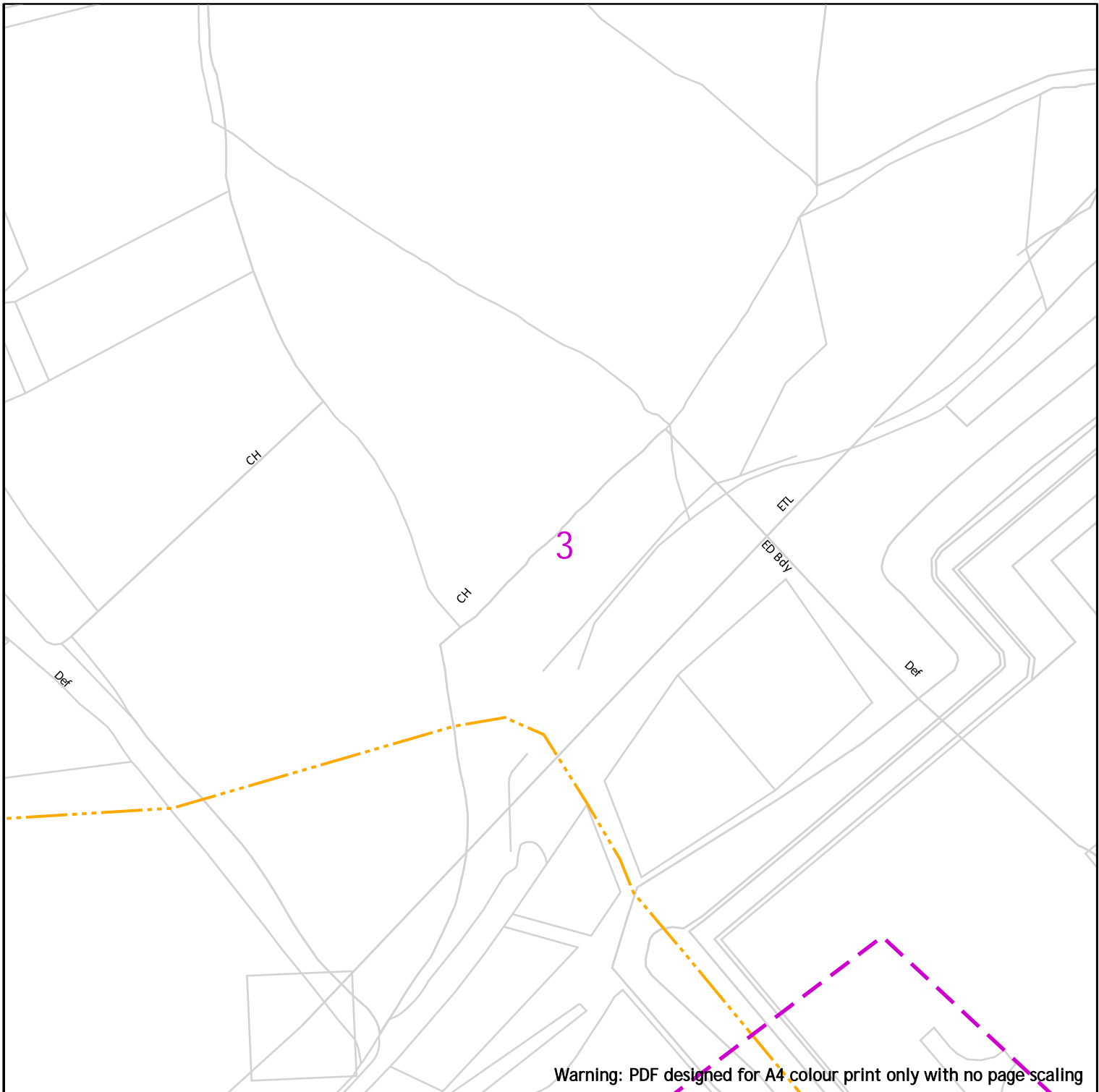

Warning: PDF designed for A4 colour print only with no page scaling



**Contact Us**  
**Mapping Enquiries:**  
 All areas 02920 278 912  
**General Enquiries:**  
 All areas 0800 912 2999

100m

Dig Sites	Area:	Line:
Low Pressure (LP) 21mbar – 75mbar		
Medium Pressure (MP) 350mbar – 2bar		
Intermediate Pressure (IP) 2bar – 7bar		
High Pressure (HP) >7bar		

**EXTREME CAUTION.**  
 Major Accident Hazard Pipeline in Vicinity  
**\*\*RISK OF DEATH OR SERIOUS INJURY\*\***  
 Prior to excavation starting you must contact the plant protection team on 02920 278912

	Change of Diameter		Line/Fire Valve
	End Cap		Governor Station
	Depth of cover		

Date Requested: 05/12/2022  
 Job Reference: 27820377  
 Site Location: 265236 200946  
 Requested by: Mr Ben Evans  
 Your Scheme/Reference: LM 115410/DK

**IMPORTANT NOTICES**

- This information is given as a guide only and its accuracy cannot be guaranteed
- The plan only shows those pipes owned by Wales & West Utilities (WWU) as its role as a licensed Gas Transporter
- Service pipes, valves, syphons, stub connections etc. may not be shown but their presence should be anticipated
- You must use safe digging practices in accordance with HS(G)47 to establish the actual position of mains, services and other apparatus before any mechanical excavation is used
- It is your responsibility to ensure this information is provided to all persons working near our plant
- If in doubt call the WWU dig team on 02920 27891

**Report damage immediately – KEEP EVERYONE AWAY FROM THE AREA**  
**0800 111 999**

**Smell gas?**  
 Call the Gas Emergency Service on 0800 111 999.

**Dial before you dig**

We need 10 days' notice

**Dial**  
 Call 029 2027 8912 before you start work.

**Investigate**  
 Before you dig, make sure you know what's below.

**Go ahead**  
 Done your research? Now you can dig safely.

Scale: 1:1250 (When plotted at A4)

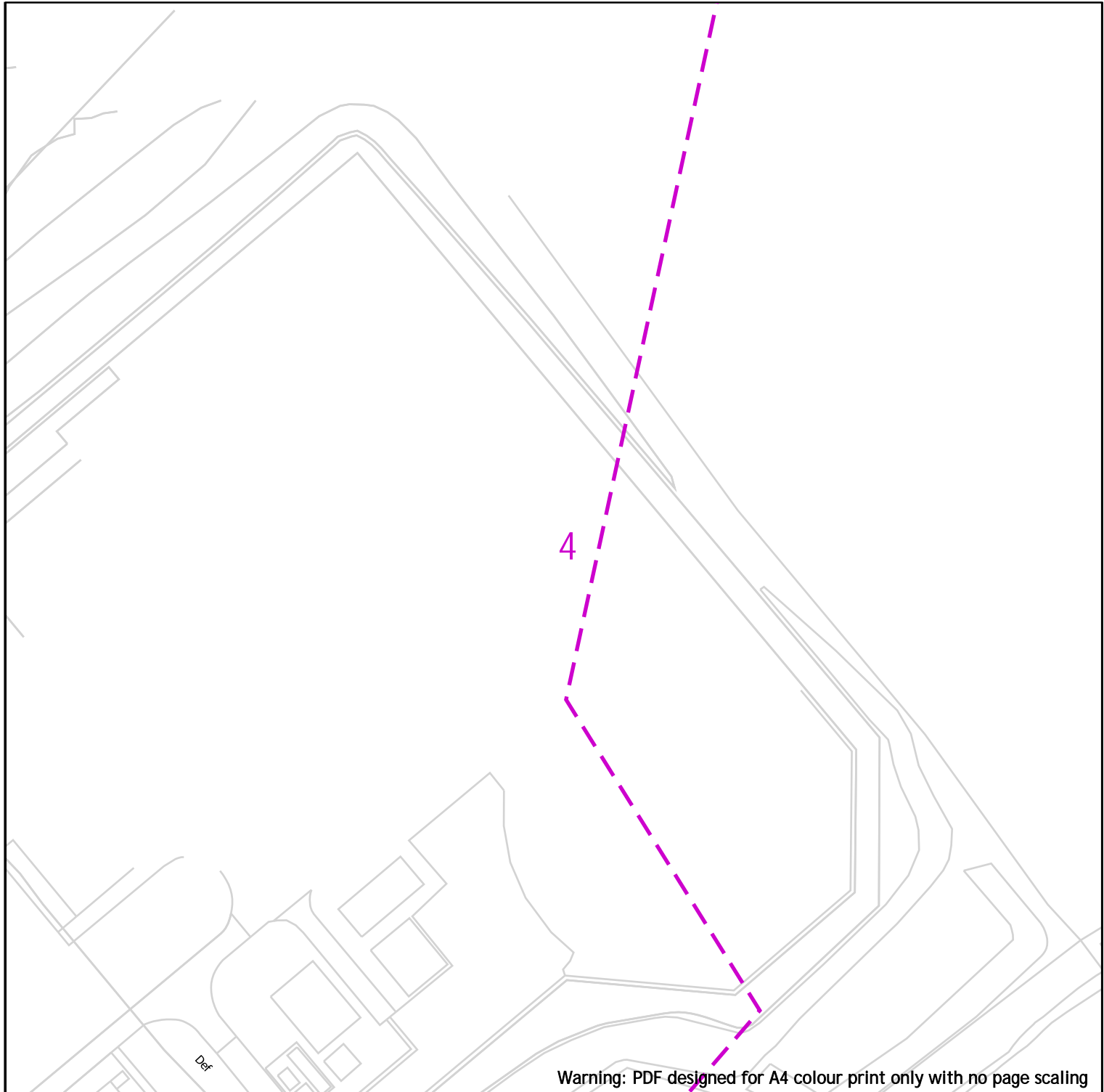

Warning: PDF designed for A4 colour print only with no page scaling



**Contact Us**  
**Mapping Enquiries:**  
 All areas 02920 278 912  
**General Enquiries:**  
 All areas 0800 912 2999

<b>Dig Sites</b>	<b>Area:</b> <b>Line:</b>
	Low Pressure (LP) 21mbar – 75mbar
	Medium Pressure (MP) 350mbar – 2bar
	Intermediate Pressure (IP) 2bar – 7bar
	High Pressure (HP) >7bar
	Change of Diameter
	End Cap
	Depth of cover
	Line/Fire Valve
	Governor Station

**EXTREME CAUTION.**  
 Major Accident Hazard Pipeline in Vicinity  
**\*\*RISK OF DEATH OR SERIOUS INJURY\*\***  
 Prior to excavation starting you must contact the plant protection team on 02920 278912

Date Requested: 05/12/2022  
 Job Reference: 27820377  
 Site Location: 265236 200946  
 Requested by: Mr Ben Evans  
 Your Scheme/Reference: LM 115410/DK

**IMPORTANT NOTICES**

- This information is given as a guide only and its accuracy cannot be guaranteed
- The plan only shows those pipes owned by Wales & West Utilities (WWU) as its role as a licensed Gas Transporter
- Service pipes, valves, syphons, stub connections etc. may not be shown but their presence should be anticipated
- You must use safe digging practices in accordance with HS(G)47 to establish the actual position of mains, services and other apparatus before any mechanical excavation is used
- It is your responsibility to ensure this information is provided to all persons working near our plant
- If in doubt call the WWU dig team on 02920 27891

**Report damage immediately – KEEP EVERYONE AWAY FROM THE AREA**  
**0800 111 999**

Smell gas?  
 Call the Gas Emergency Service on 0800 111 999.

**Dial before you dig**

We need 10 days' notice

**dial**  
 Call 029 2027 8912 before you start work.

**Investigate**  
 Before you dig, make sure you know what's below.

**Go ahead**  
 Done your research? Now you can dig safely.

Scale: 1:1250 (When plotted at A4)

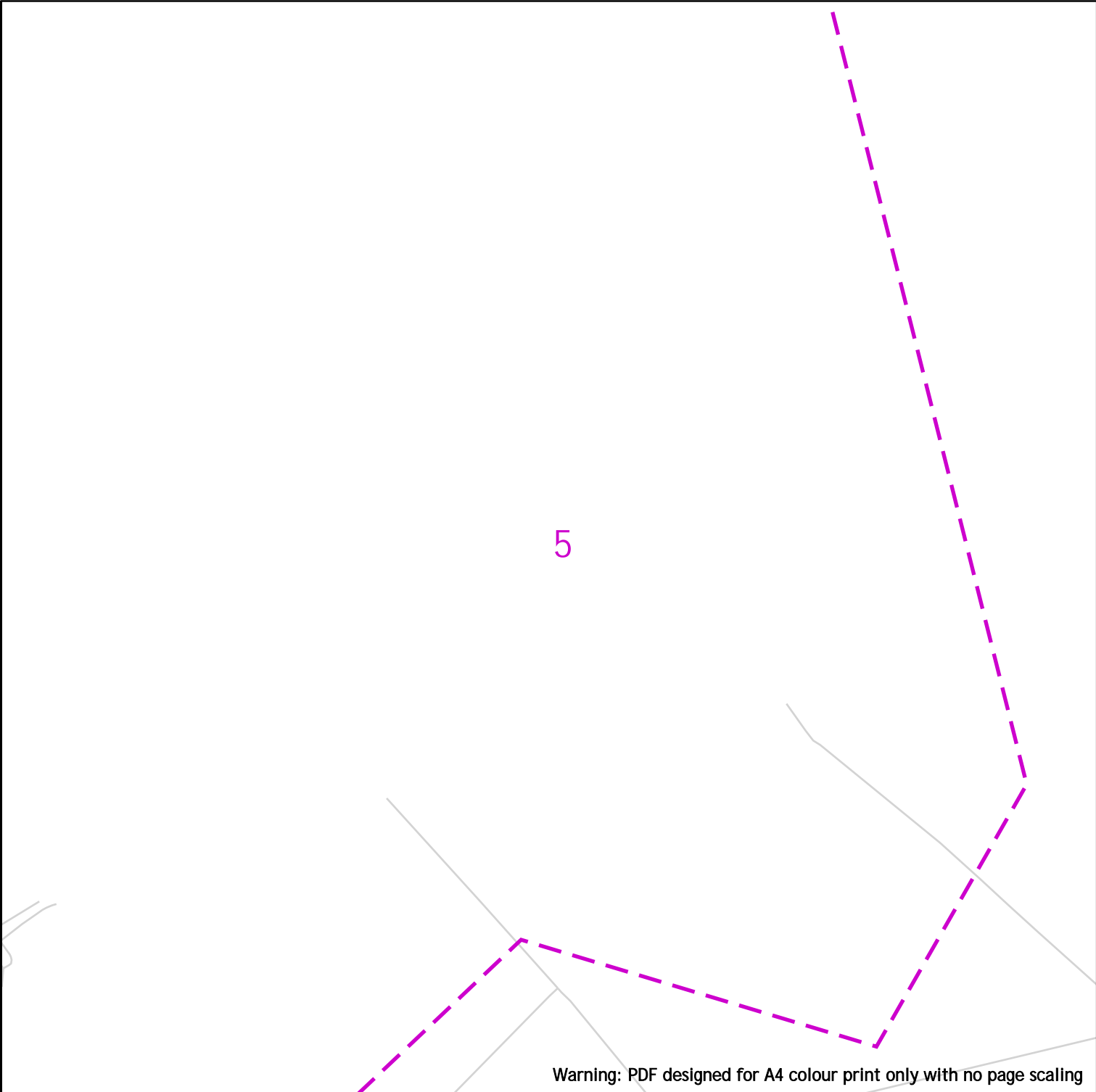

Warning: PDF designed for A4 colour print only with no page scaling



**Contact Us**  
**Mapping Enquiries:**  
 All areas 02920 278 912  
**General Enquiries:**  
 All areas 0800 912 2999

<b>Dig Sites</b>	<b>Area:</b>	<b>Line:</b>
	Low Pressure (LP) 21mbar – 75mbar	
	Medium Pressure (MP) 350mbar – 2bar	
	Intermediate Pressure (IP) 2bar – 7bar	
	High Pressure (HP) >7bar	

**EXTREME CAUTION.**  
 Major Accident Hazard Pipeline in Vicinity  
**\*\*RISK OF DEATH OR SERIOUS INJURY\*\***  
 Prior to excavation starting you must contact the plant protection team on 02920 278912

	Change of Diameter		Line/Fire Valve
	End Cap		Governor Station
	Depth of cover		

Date Requested: 05/12/2022  
 Job Reference: 27820377  
 Site Location: 265236 200946  
 Requested by: Mr Ben Evans  
 Your Scheme/Reference: LM 115410/DK  
 Scale: 1:1250 (When plotted at A4)

**IMPORTANT NOTICES**

- This information is given as a guide only and its accuracy cannot be guaranteed
- The plan only shows those pipes owned by Wales & West Utilities (WWU) as its role as a licensed Gas Transporter
- Service pipes, valves, syphons, stub connections etc. may not be shown but their presence should be anticipated
- You must use safe digging practices in accordance with HS(G)47 to establish the actual position of mains, services and other apparatus before any mechanical excavation is used
- It is your responsibility to ensure this information is provided to all persons working near our plant
- If in doubt call the WWU dig team on 02920 27891

**Report damage immediately – KEEP EVERYONE AWAY FROM THE AREA**  
**0800 111 999**

Smell gas?  
 Call the Gas Emergency Service on 0800 111 999.

**Dial before you dig**

We need 10 days' notice

**Go ahead**  
 Done your research? Now you can dig safely.

Call 029 2027 8912 before you start work.  
 Investigate Before you dig, make sure you know what's below.

Ordnance Survey Licence number 0100044308.

Spring

6

Warning: PDF designed for A4 colour print only with no page scaling



Contact Us  
Mapping Enquiries:  
All areas 02920 278 912  
General Enquiries:  
All areas 0800 912 2999

100m

Dig Sites	Area:	Line:
	Low Pressure (LP) 21mbar – 75mbar	
	Medium Pressure (MP) 350mbar – 2bar	
	Intermediate Pressure (IP) 2bar – 7bar	
	High Pressure (HP) >7bar	

**EXTREME CAUTION.**  
Major Accident Hazard Pipeline in Vicinity  
**\*\*RISK OF DEATH OR SERIOUS INJURY\*\***  
Prior to excavation starting you must contact the plant protection team on 02920 278912

IMPORTANT NOTICES

- This information is given as a guide only and its accuracy cannot be guaranteed
- The plan only shows those pipes owned by Wales & West Utilities (WWU) as its role as a licensed Gas Transporter
- Service pipes, valves, syphons, stub connections etc. may not be shown but their presence should be anticipated
- You must use safe digging practices in accordance with HS(G)47 to establish the actual position of mains, services and other apparatus before any mechanical excavation is used
- It is your responsibility to ensure this information is provided to all persons working near our plant
- If in doubt call the WWU dig team on 02920 27891

**Report damage immediately – KEEP EVERYONE AWAY FROM THE AREA**  
**0800 111 999**

Date Requested: 05/12/2022  
Job Reference: 27820377  
Site Location: 265236 200946  
Requested by: Mr Ben Evans  
  
Your Scheme/Reference: LM  
115410/DK

Scale: 1:1250 (When plotted at A4)

Smell gas?  
Call the Gas Emergency Service on  
**0800 111 999.**

**Dial before you dig**

We need 10 days' notice

**dial**  
Call **029 2027 8912**  
before you start work.

**Investigate**  
Before you dig, make sure  
you know what's below.

**Go ahead**  
Done your research?  
Now you can dig safely.

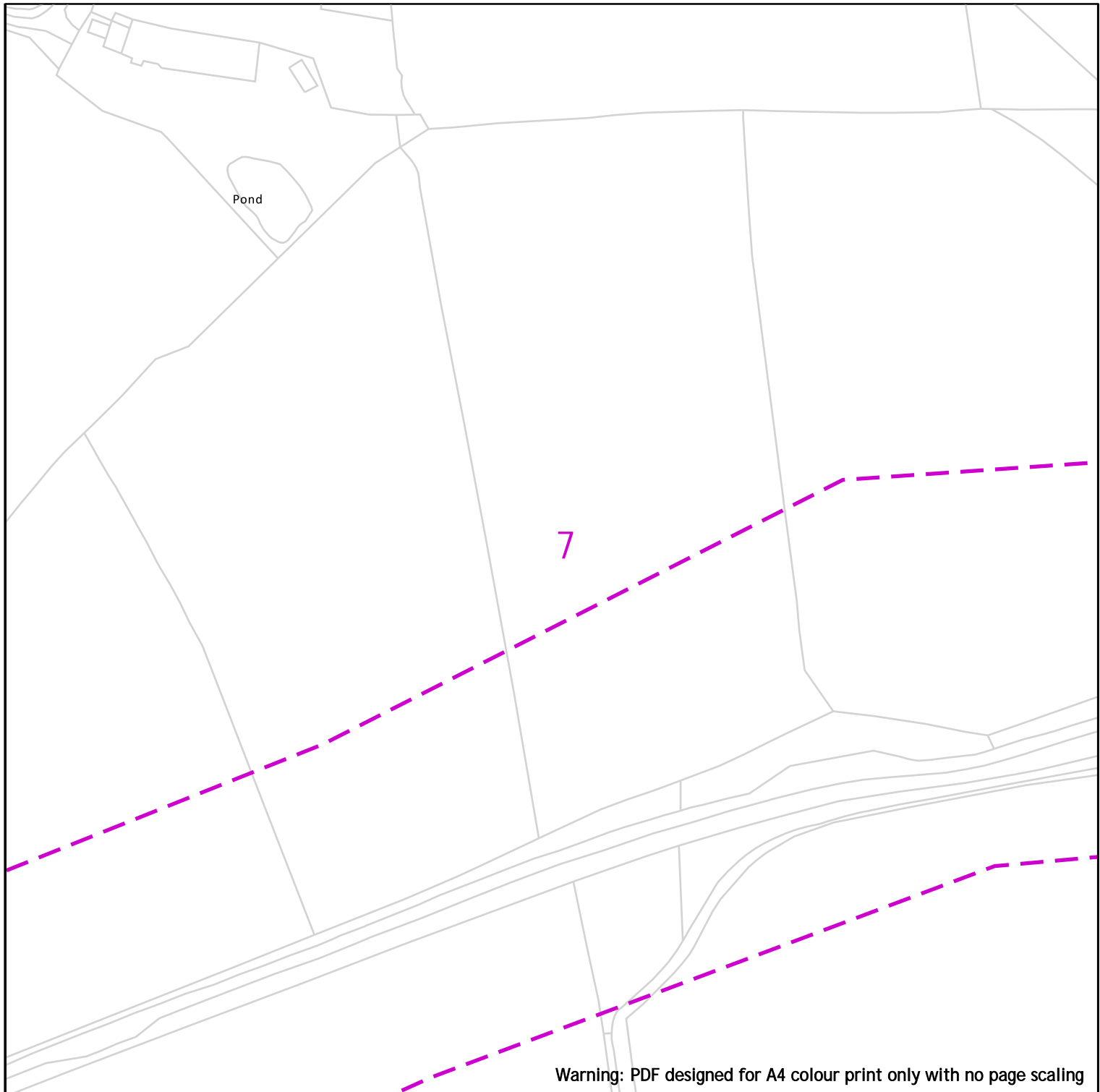

Warning: PDF designed for A4 colour print only with no page scaling



**Contact Us**  
**Mapping Enquiries:**  
 All areas 02920 278 912  
**General Enquiries:**  
 All areas 0800 912 2999

100m

Dig Sites	Area: [---]	Line: [---]
[---]	Low Pressure (LP) 21mbar – 75mbar	[---]
[---]	Medium Pressure (MP) 350mbar – 2bar	[---]
[---]	Intermediate Pressure (IP) 2bar – 7bar	[---]
[---]	High Pressure (HP) >7bar	[---]

[---]	Change of Diameter	[X]	Line/Fire Valve
[ ]	End Cap	[X]	Governor Station
[ < ]	Depth of cover		

**EXTREME CAUTION.**  
 Major Accident Hazard Pipeline in Vicinity  
**\*\*RISK OF DEATH OR SERIOUS INJURY\*\***  
 Prior to excavation starting you must contact the plant protection team on 02920 278912

Date Requested: 05/12/2022  
 Job Reference: 27820377  
 Site Location: 265236 200946  
 Requested by: Mr Ben Evans  
 Your Scheme/Reference: LM 115410/DK

**IMPORTANT NOTICES**

- This information is given as a guide only and its accuracy cannot be guaranteed
- The plan only shows those pipes owned by Wales & West Utilities (WU) as its role as a licensed Gas Transporter
- Service pipes, valves, syphons, stub connections etc. may not be shown but their presence should be anticipated
- You must use safe digging practices in accordance with HS(G)47 to establish the actual position of mains, services and other apparatus before any mechanical excavation is used
- It is your responsibility to ensure this information is provided to all persons working near our plant
- If in doubt call the WU dig team on 02920 27891

**Report damage immediately – KEEP EVERYONE AWAY FROM THE AREA**  
**0800 111 999**

Smell gas?  
 Call the Gas Emergency Service on 0800 111 999.

**Dial before you dig**

We need 10 days' notice

**Dial**  
 Call 029 2027 8912 before you start work.

**Investigate**  
 Before you dig, make sure you know what's below.

**Go ahead**  
 Done your research? Now you can dig safely.

Scale: 1:1250 (When plotted at A4)



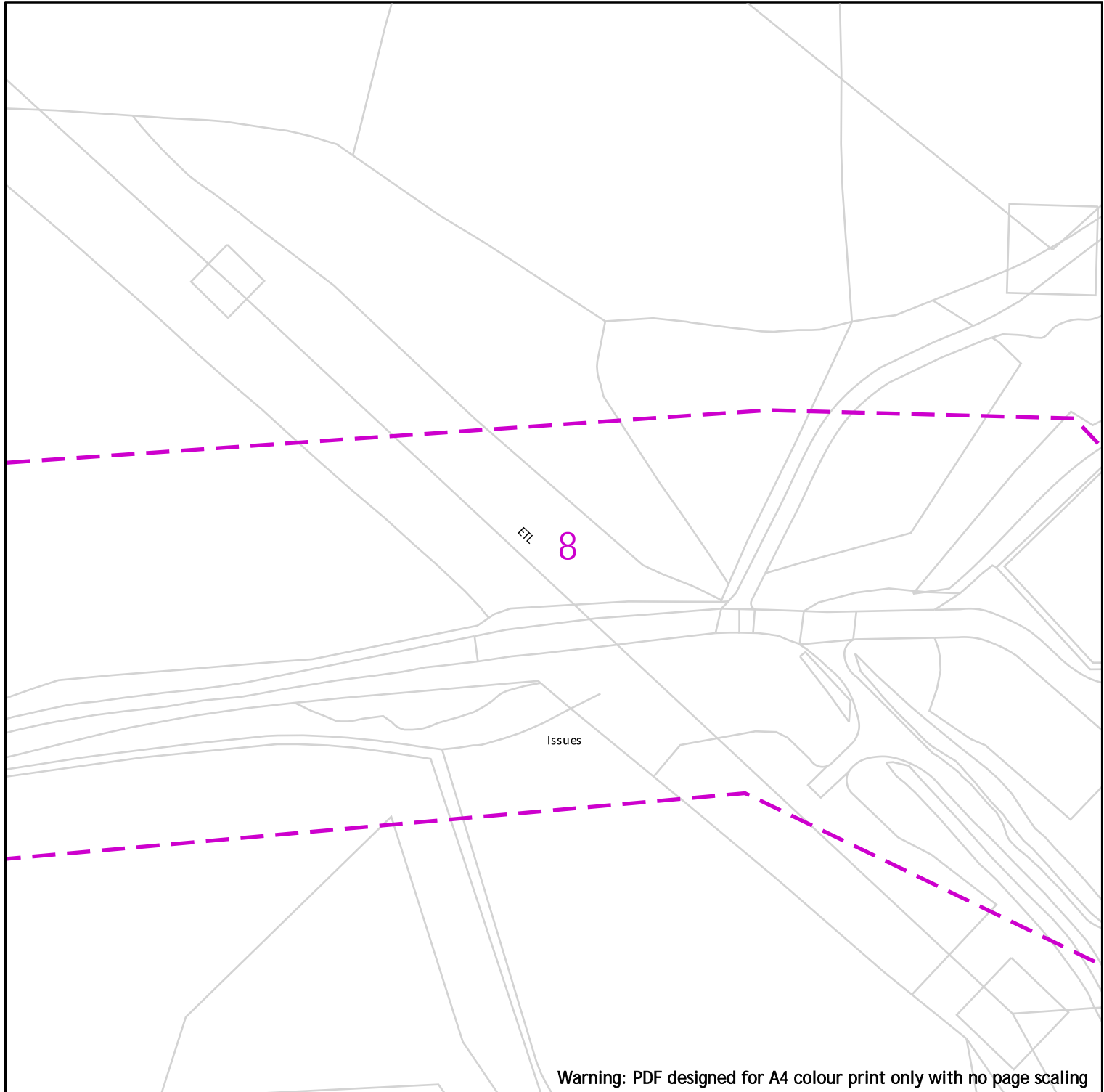

Warning: PDF designed for A4 colour print only with no page scaling



**Contact Us**

**Mapping Enquiries:**  
All areas 02920 278 912  
**General Enquiries:**  
All areas 0800 912 2999

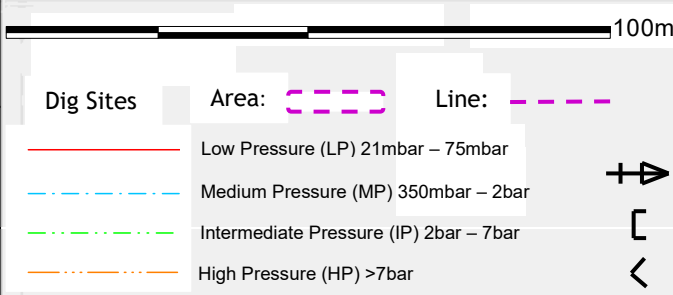

**EXTREME CAUTION.**  
Major Accident Hazard Pipeline in Vicinity  
**\*\*RISK OF DEATH OR SERIOUS INJURY\*\***  
Prior to excavation starting you must contact the plant protection team on 02920 278912

Date Requested: 05/12/2022  
Job Reference: 27820377  
Site Location: 265236 200946  
Requested by: Mr Ben Evans  
  
Your Scheme/Reference: LM  
115410/DK

**IMPORTANT NOTICES**

- This information is given as a guide only and its accuracy cannot be guaranteed
- The plan only shows those pipes owned by Wales & West Utilities (WWU) as its role as a licensed Gas Transporter
- Service pipes, valves, syphons, stub connections etc. may not be shown but their presence should be anticipated
- You must use safe digging practices in accordance with HS(G)47 to establish the actual position of mains, services and other apparatus before any mechanical excavation is used
- It is your responsibility to ensure this information is provided to all persons working near our plant
- If in doubt call the WWU dig team on 02920 27891

**Report damage immediately – KEEP EVERYONE AWAY FROM THE AREA**  
**0800 111 999**

Scale: 1:1250 (When plotted at A4)

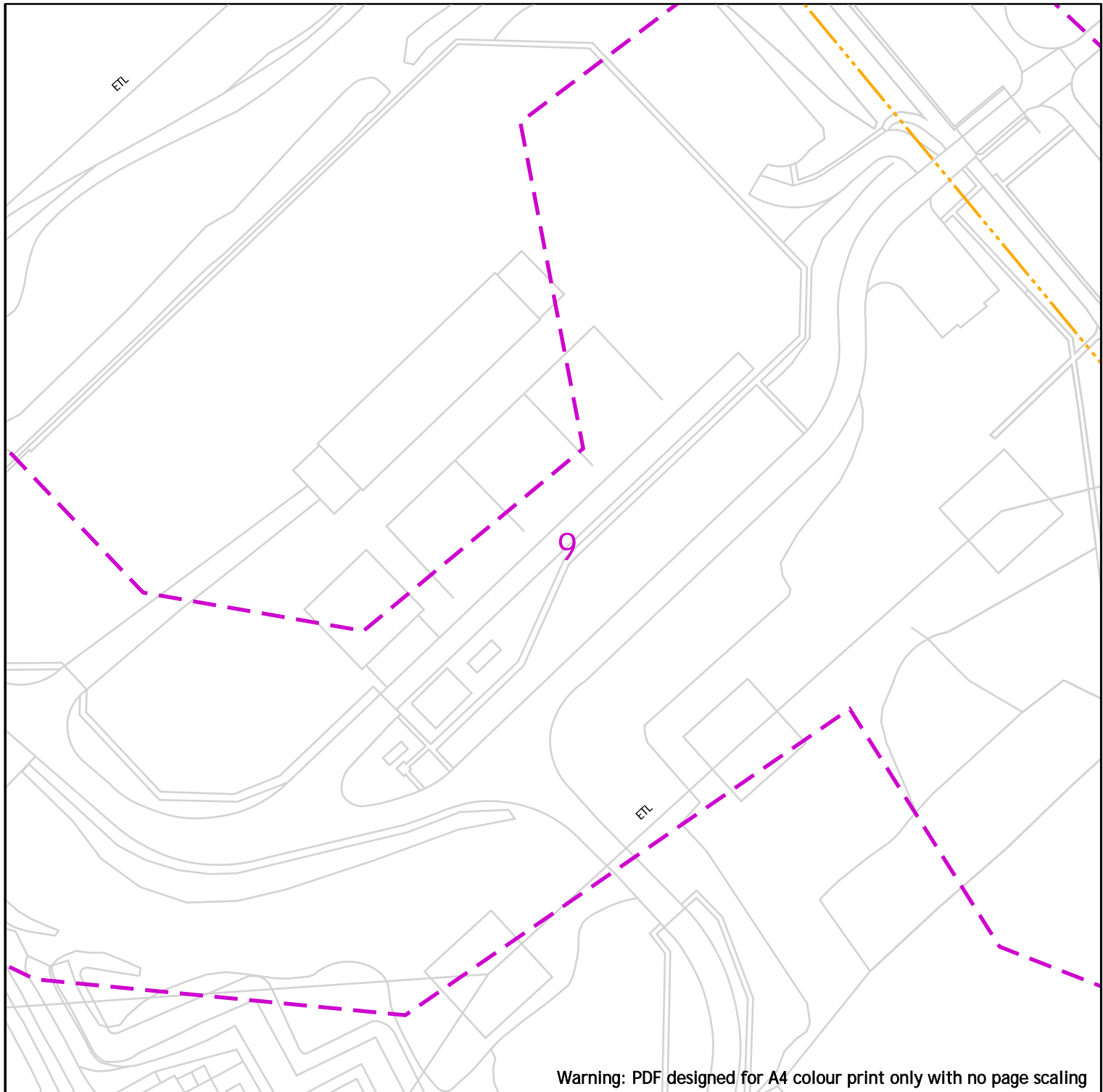

Warning: PDF designed for A4 colour print only with no page scaling



**Contact Us**  
**Mapping Enquiries:**  
 All areas 02920 278 912  
**General Enquiries:**  
 All areas 0800 912 2999

100m

<b>Dig Sites</b>	<b>Area:</b>	<b>Line:</b>
	Low Pressure (LP) 21mbar – 75mbar	
	Medium Pressure (MP) 350mbar – 2bar	
	Intermediate Pressure (IP) 2bar – 7bar	
	High Pressure (HP) >7bar	

**EXTREME CAUTION.**  
 Major Accident Hazard Pipeline in Vicinity  
**\*\*RISK OF DEATH OR SERIOUS INJURY\*\***  
 Prior to excavation starting you must contact the plant protection team on 02920 278912

Date Requested: 05/12/2022  
 Job Reference: 27820377  
 Site Location: 265236 200946  
 Requested by: Mr Ben Evans  
 Your Scheme/Reference: LM 115410/DK

**IMPORTANT NOTICES**

- This information is given as a guide only and its accuracy cannot be guaranteed
- The plan only shows those pipes owned by Wales & West Utilities (WU) as its role as a licensed Gas Transporter
- Service pipes, valves, syphons, stub connections etc. may not be shown but their presence should be anticipated
- You must use safe digging practices in accordance with HS(G)47 to establish the actual position of mains, services and other apparatus before any mechanical excavation is used
- It is your responsibility to ensure this information is provided to all persons working near our plant
- If in doubt call the WU dig team on 02920 27891

**Report damage immediately – KEEP EVERYONE AWAY FROM THE AREA**  
**0800 111 999**

Smell gas?  
 Call the Gas Emergency Service on 0800 111 999.

**Dial before you dig**  
 Call 029 2027 8912 before you start work.  
**Investigate**  
 Before you dig, make sure you know what's below.  
**Go ahead**  
 Done your research? Now you can dig safely.

We need 10 days' notice

Scale: 1:1250 (When plotted at A4)

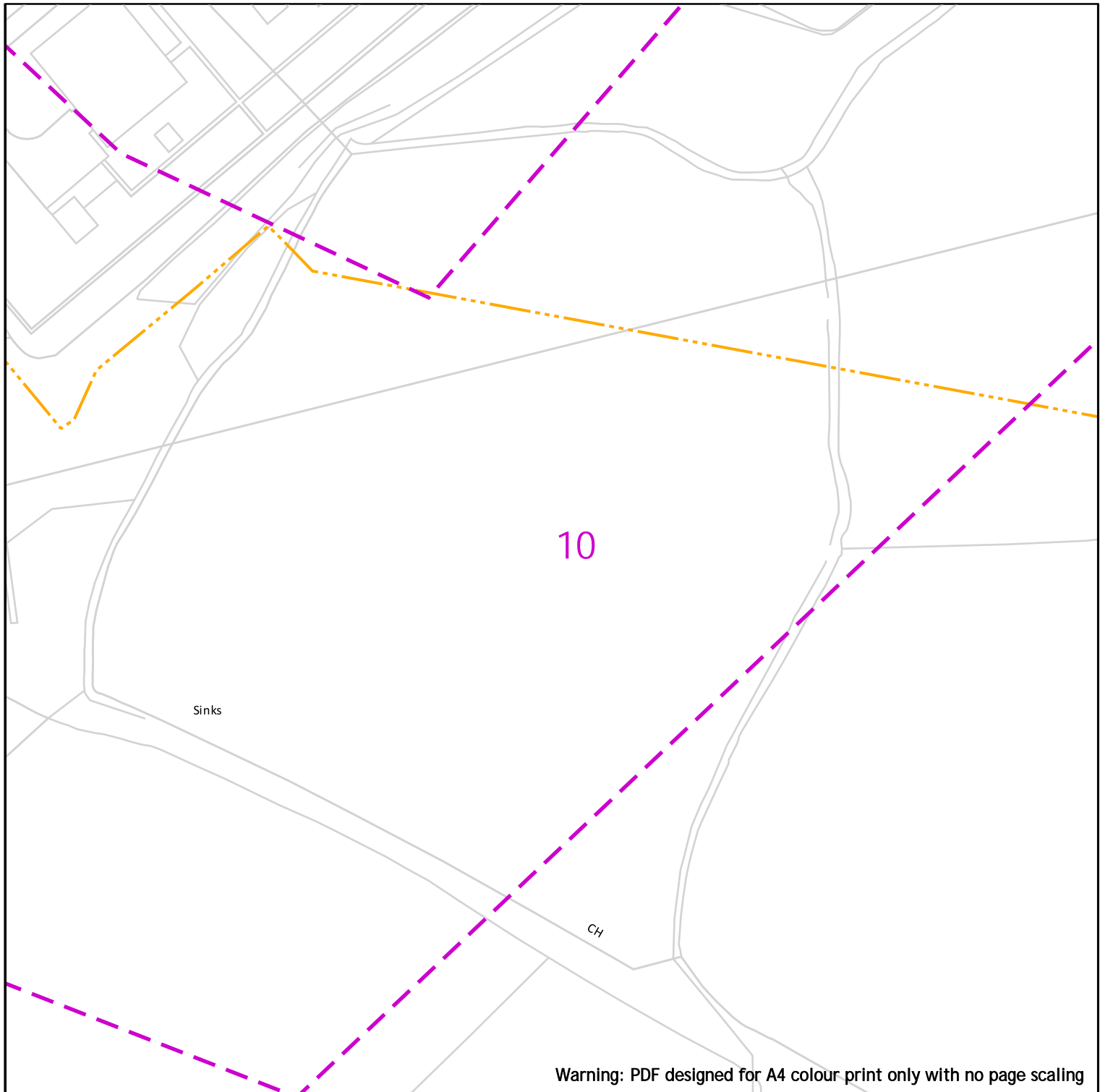

Warning: PDF designed for A4 colour print only with no page scaling



**Contact Us**

**Mapping Enquiries:**

All areas 02920 278 912

**General Enquiries:**

All areas 0800 912 2999



**Dig Sites**

Area:

Line:

- Low Pressure (LP) 21mbar – 75mbar
- Medium Pressure (MP) 350mbar – 2bar
- Intermediate Pressure (IP) 2bar – 7bar
- High Pressure (HP) >7bar



Change of Diameter



End Cap



Depth of cover



Line/Fire Valve



Governor Station

**EXTREME CAUTION.**  
Major Accident Hazard Pipeline in Vicinity  
**\*\*RISK OF DEATH OR SERIOUS INJURY\*\***  
Prior to excavation starting you must contact the plant protection team on 02920 278912

Date Requested: 05/12/2022  
Job Reference: 27820377  
Site Location: 265236 200946  
Requested by: Mr Ben Evans

Your Scheme/Reference: LM  
115410/DK

**IMPORTANT NOTICES**

- This information is given as a guide only and its accuracy cannot be guaranteed
- The plan only shows those pipes owned by Wales & West Utilities (WWU) as its role as a licensed Gas Transporter
- Service pipes, valves, syphons, stub connections etc. may not be shown but their presence should be anticipated
- You must use safe digging practices in accordance with HS(G)47 to establish the actual position of mains, services and other apparatus before any mechanical excavation is used
- It is your responsibility to ensure this information is provided to all persons working near our plant
- If in doubt call the WWU dig team on 02920 27891

**Report damage immediately – KEEP EVERYONE AWAY FROM THE AREA**  
**0800 111 999**

Scale: 1:1250 (When plotted at A4)

Smell gas?  
Call the Gas Emergency Service on 0800 111 999.

**Dial before you dig**

**Call 029 2027 8912** before you start work.

**Investigate**  
Before you dig, make sure you know what's below.

**Go ahead**  
Done your research? Now you can dig safely.

We need 10 days' notice

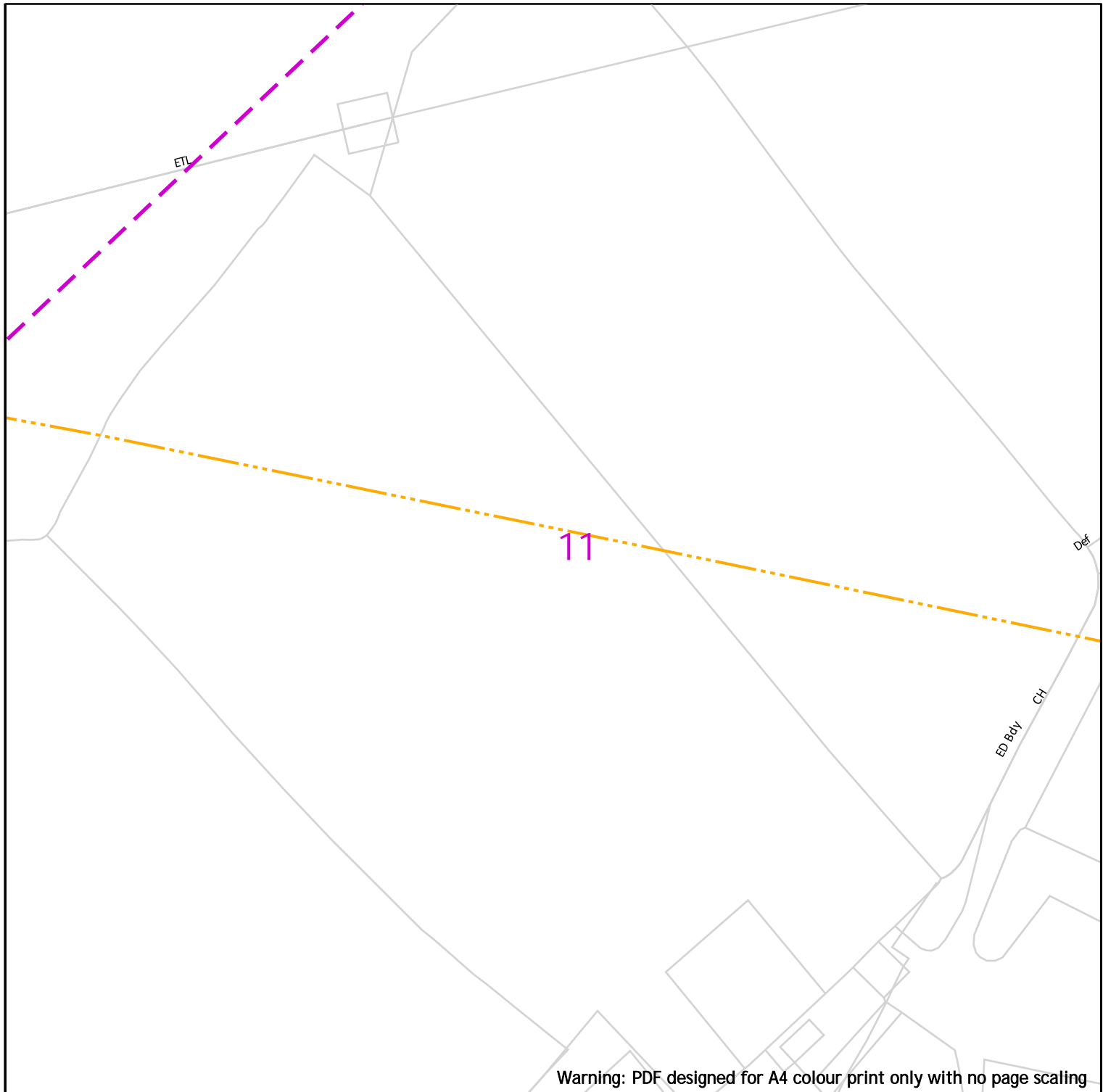

Warning: PDF designed for A4 colour print only with no page scaling



**Contact Us**  
**Mapping Enquiries:**  
 All areas 02920 278 912  
**General Enquiries:**  
 All areas 0800 912 2999

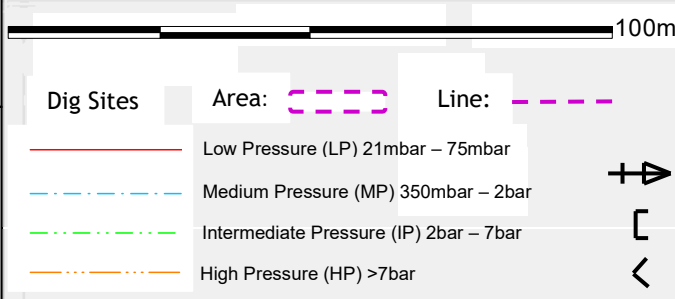

**EXTREME CAUTION.**  
 Major Accident Hazard Pipeline in Vicinity  
**\*\*RISK OF DEATH OR SERIOUS INJURY\*\***  
 Prior to excavation starting you must contact the plant protection team on 02920 278912

Date Requested: 05/12/2022  
 Job Reference: 27820377  
 Site Location: 265236 200946  
 Requested by: Mr Ben Evans  
 Your Scheme/Reference: LM 115410/DK

**IMPORTANT NOTICES**

- This information is given as a guide only and its accuracy cannot be guaranteed
- The plan only shows those pipes owned by Wales & West Utilities (WWU) as its role as a licensed Gas Transporter
- Service pipes, valves, syphons, stub connections etc. may not be shown but their presence should be anticipated
- You must use safe digging practices in accordance with HS(G)47 to establish the actual position of mains, services and other apparatus before any mechanical excavation is used
- It is your responsibility to ensure this information is provided to all persons working near our plant
- If in doubt call the WWU dig team on 02920 27891

**Report damage immediately – KEEP EVERYONE AWAY FROM THE AREA**  
**0800 111 999**

Scale: 1:1250 (When plotted at A4)

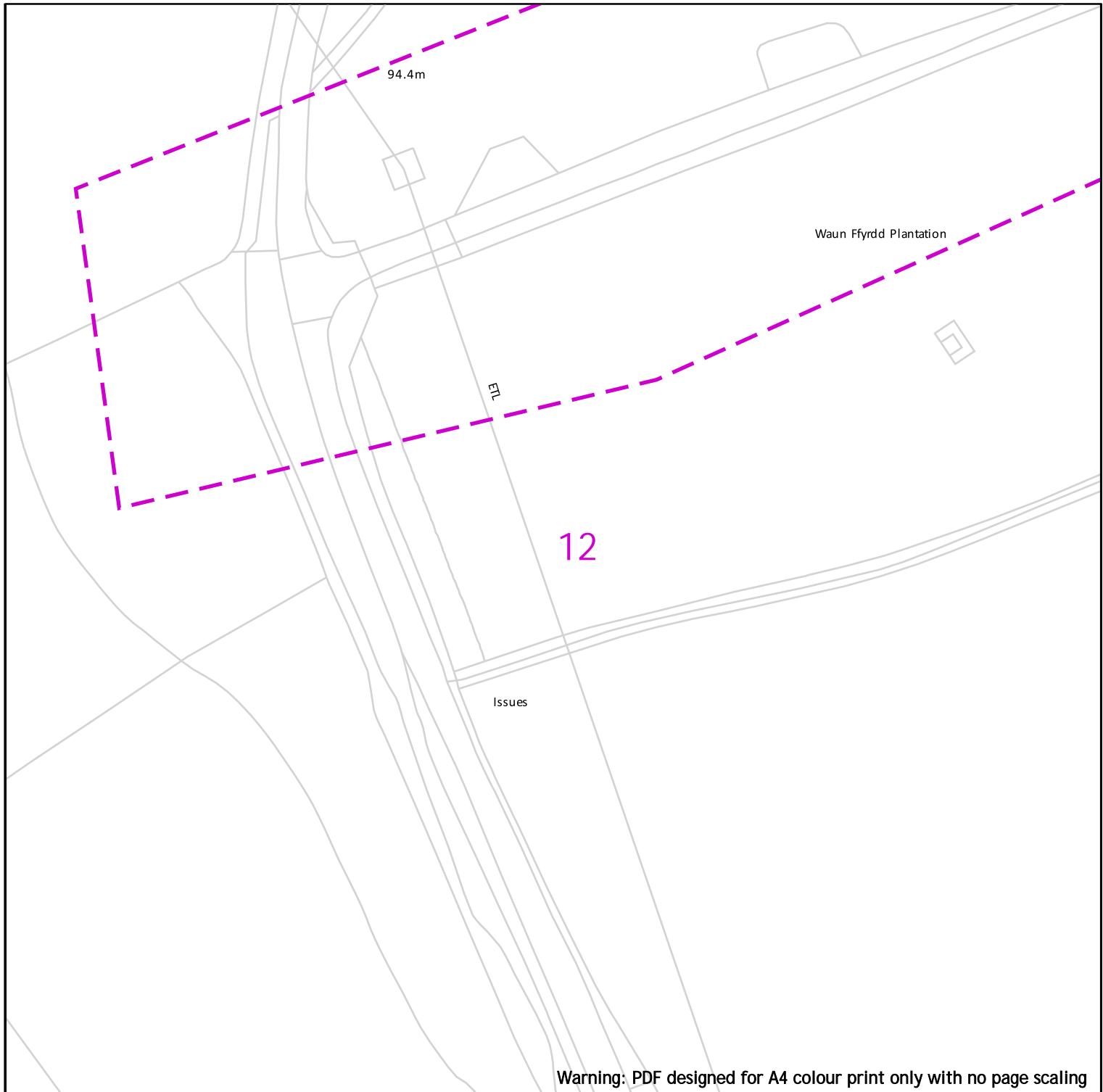

Warning: PDF designed for A4 colour print only with no page scaling



**Contact Us**  
**Mapping Enquiries:**  
 All areas 02920 278 912  
**General Enquiries:**  
 All areas 0800 912 2999

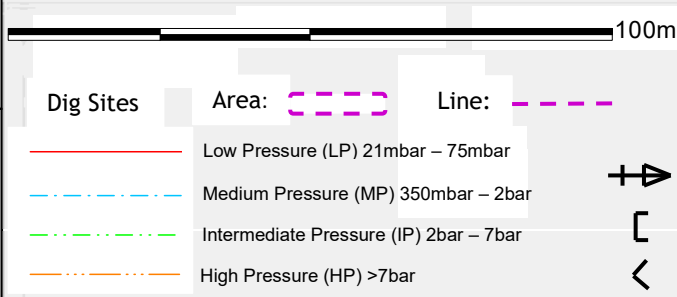

**EXTREME CAUTION.**  
 Major Accident Hazard Pipeline in Vicinity  
**\*\*RISK OF DEATH OR SERIOUS INJURY\*\***  
 Prior to excavation starting you must contact the plant protection team on 02920 278912

Date Requested: 05/12/2022  
 Job Reference: 27820377  
 Site Location: 265236 200946  
 Requested by: Mr Ben Evans

Your Scheme/Reference: LM  
 115410/DK

**IMPORTANT NOTICES**

- This information is given as a guide only and its accuracy cannot be guaranteed
- The plan only shows those pipes owned by Wales & West Utilities (WWU) as its role as a licensed Gas Transporter
- Service pipes, valves, syphons, stub connections etc. may not be shown but their presence should be anticipated
- You must use safe digging practices in accordance with HS(G)47 to establish the actual position of mains, services and other apparatus before any mechanical excavation is used
- It is your responsibility to ensure this information is provided to all persons working near our plant
- If in doubt call the WWU dig team on 02920 27891

**Report damage immediately – KEEP EVERYONE AWAY FROM THE AREA**  
**0800 111 999**

Smell gas?  
 Call the Gas Emergency Service on  
**0800 111 999.**

**Dial before you dig**  
 Call **029 2027 8912** before you start work.  
**Investigate**  
 Before you dig, make sure you know what's below.  
**Go ahead**  
 Done your research? Now you can dig safely.

We need 10 days' notice

Scale: 1:1250 (When plotted at A4)

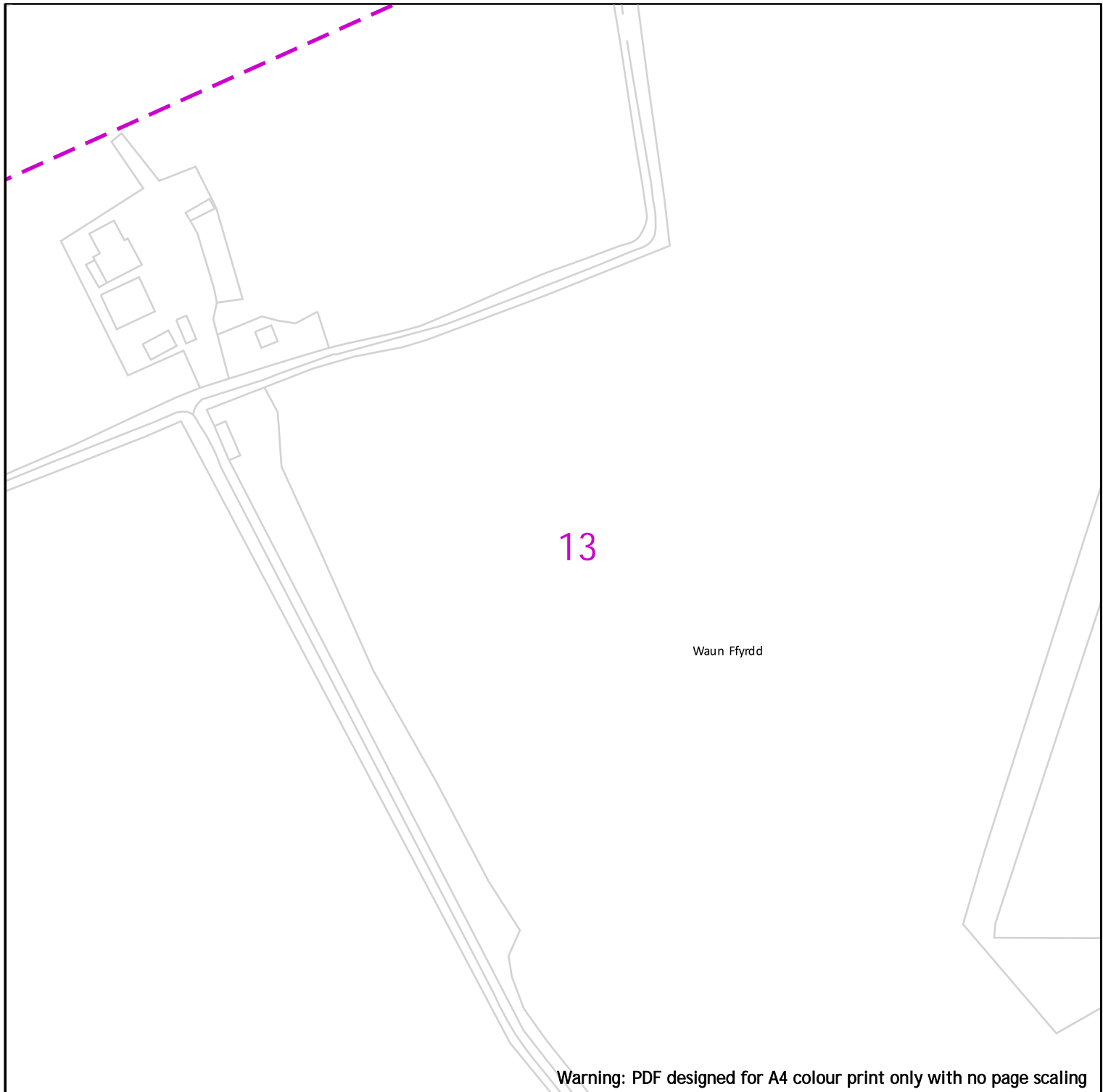

Warning: PDF designed for A4 colour print only with no page scaling



**Contact Us**  
**Mapping Enquiries:**  
 All areas 02920 278 912  
**General Enquiries:**  
 All areas 0800 912 2999

100m

<b>Dig Sites</b>	<b>Area:</b>	<b>Line:</b>
	Low Pressure (LP) 21mbar – 75mbar	
	Medium Pressure (MP) 350mbar – 2bar	
	Intermediate Pressure (IP) 2bar – 7bar	
	High Pressure (HP) >7bar	

**EXTREME CAUTION.**  
 Major Accident Hazard Pipeline in Vicinity  
**\*\*RISK OF DEATH OR SERIOUS INJURY\*\***  
 Prior to excavation starting you must contact the plant protection team on 02920 278912

Date Requested: 05/12/2022  
 Job Reference: 27820377  
 Site Location: 265236 200946  
 Requested by: Mr Ben Evans  
 Your Scheme/Reference: LM 115410/DK  
 Scale: 1:1250 (When plotted at A4)

**IMPORTANT NOTICES**

- This information is given as a guide only and its accuracy cannot be guaranteed
- The plan only shows those pipes owned by Wales & West Utilities (WWU) as its role as a licensed Gas Transporter
- Service pipes, valves, syphons, stub connections etc. may not be shown but their presence should be anticipated
- You must use safe digging practices in accordance with HS(G)47 to establish the actual position of mains, services and other apparatus before any mechanical excavation is used
- It is your responsibility to ensure this information is provided to all persons working near our plant
- If in doubt call the WWU dig team on 02920 27891

**Report damage immediately – KEEP EVERYONE AWAY FROM THE AREA**  
**0800 111 999**

**Smell gas?**  
 Call the Gas Emergency Service on 0800 111 999.

**Dial before you dig**

We need 10 days' notice

**Call 029 2027 8912** before you start work.

**Investigate**  
 Before you dig, make sure you know what's below.

**Go ahead**  
 Done your research? Now you can dig safely.

Crown Copyright © - Reproduced by permission of Ordnance Survey on behalf of HMSO. And database right 2020. All rights reserved. Ordnance Survey Licence number 0100044308.

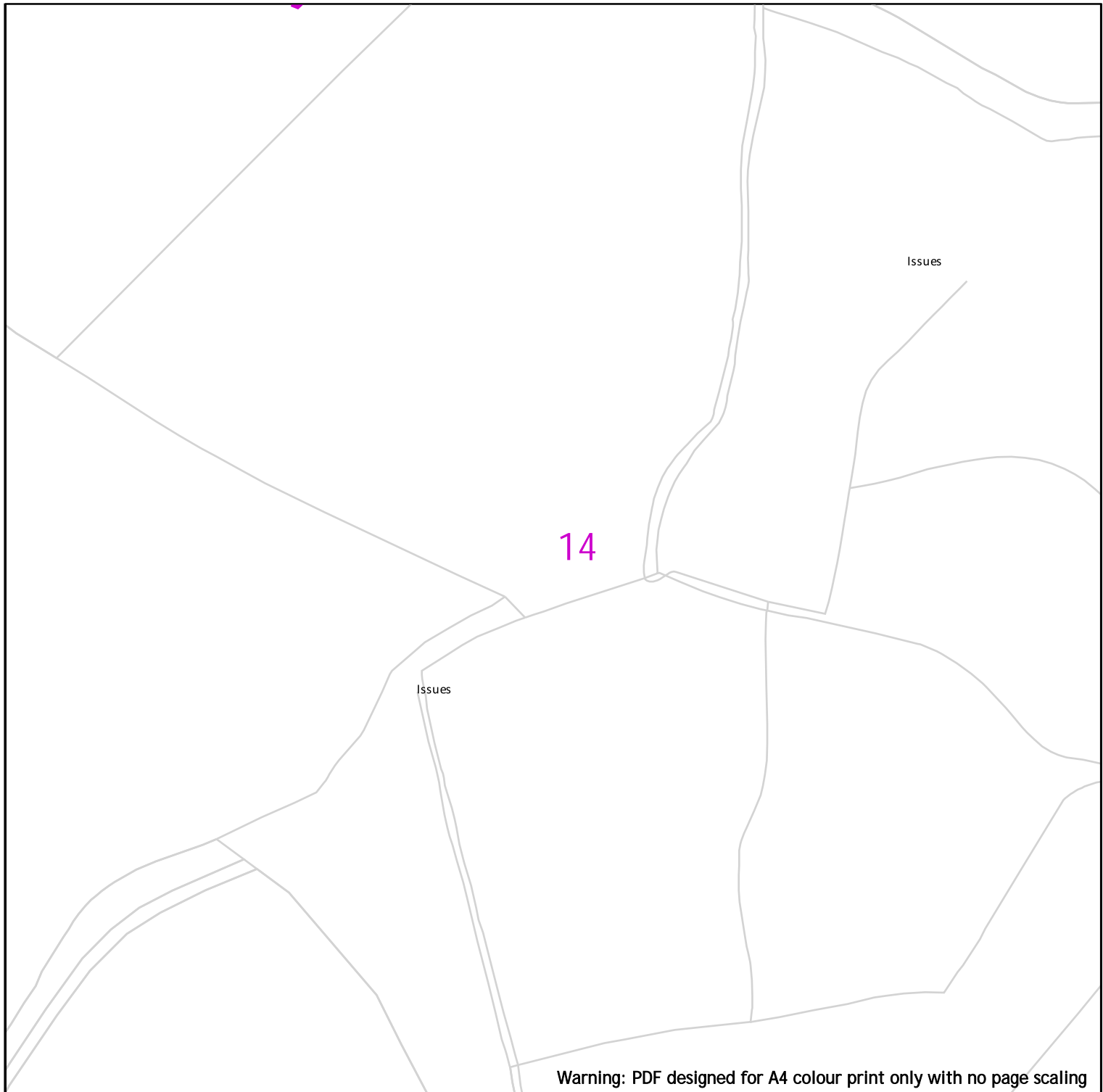

Warning: PDF designed for A4 colour print only with no page scaling



**Contact Us**  
**Mapping Enquiries:**  
 All areas 02920 278 912  
**General Enquiries:**  
 All areas 0800 912 2999

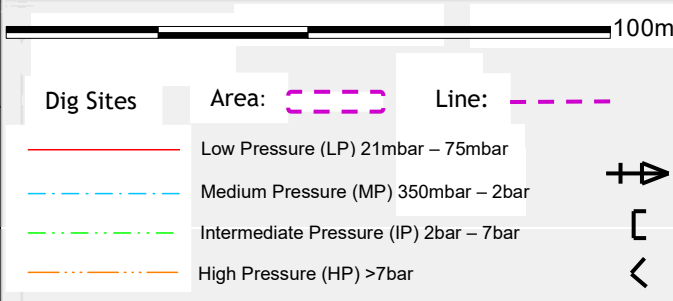

**EXTREME CAUTION.**  
 Major Accident Hazard Pipeline in Vicinity  
**\*\*RISK OF DEATH OR SERIOUS INJURY\*\***  
 Prior to excavation starting you must contact the plant protection team on 02920 278912

Date Requested: 05/12/2022  
 Job Reference: 27820377  
 Site Location: 265236 200946  
 Requested by: Mr Ben Evans  
 Your Scheme/Reference: LM 115410/DK

**IMPORTANT NOTICES**

- This information is given as a guide only and its accuracy cannot be guaranteed
- The plan only shows those pipes owned by Wales & West Utilities (WWU) as its role as a licensed Gas Transporter
- Service pipes, valves, syphons, stub connections etc. may not be shown but their presence should be anticipated
- You must use safe digging practices in accordance with HS(G)47 to establish the actual position of mains, services and other apparatus before any mechanical excavation is used
- It is your responsibility to ensure this information is provided to all persons working near our plant
- If in doubt call the WWU dig team on 02920 27891

**Report damage immediately – KEEP EVERYONE AWAY FROM THE AREA**  
**0800 111 999**

Scale: 1:1250 (When plotted at A4)

**WW/SP/SSW/22**



---

---

SPECIFICATION FOR

**SAFE WORKING IN THE VICINITY OF PIPELINES AND  
ASSOCIATED INSTALLATIONS OPERATING ABOVE 2  
BARG - REQUIREMENTS FOR THIRD PARTIES**

---

---

**JUNE 2013**



## CONTENTS

	<b>Page</b>
FOREWORD	iii
BRIEF HISTORY	iii
INTRODUCTION	1
DOCUMENT FLOWCHART	2
1. SCOPE	3
2. FORMAL CONSENT	3
2.1 Within an Easement	3
2.2 Within the Highway	3
2.3 Within the Area of Interest	4
3. HS&E CONSIDERATIONS	4
3.1 Safe Control of Operations	4
3.2 Deep Excavations	4
3.3 Positioning of Plant	4
3.4 General	4
4. PIPELINE LOCATING	4
5. SLABBING AND OTHER PROTECTIVE MEASURES	5
6. EXCAVATION	5
6.1 In Proximity to a Pipeline in an Easement	5
6.2 In Proximity to a Pipeline in the Highway	6
6.3 Crossing Over a Pipeline	6
6.4 Crossing Below a Pipeline	6
6.5 Cathodic Protection	6
7. CONSTRUCTION TRAFFIC	7
8. SPECIFIC ACTIVITIES	7
8.1 No-Dig Techniques	7
8.2 Increase in Cover	7
8.3 Piling	7
8.4 Demolition	7
8.5 Blasting	8
8.6 Surface Mineral Extraction	8
8.7 Deep Mining	8

	<b>Page</b>
8.8 Landfilling	8
8.9 Pressure Testing	8
8.10 Seismic Surveys	8
8.11 Hot Work	9
8.12 Wind Turbines	9
9. BACKFILLING	9
10. ACTION IN THE CASE OF DAMAGE TO THE PIPELINE	9
11. REFERENCES	10
12. GLOSSARY OF TERMS	10
<b>APPENDIX</b>	
A SITE DOCUMENT CONTROL FORM	11
End Note	13

## FOREWORD

This Specification was approved, by Chris Clarke, Director of Asset Management and HS&E Dept on 21<sup>st</sup> June 2013 for use by managers, engineers and supervisors throughout Wales & West Utilities Limited.

Documents are revised, when necessary, by the issue of new editions. Users should ensure that they are in possession of the latest edition by referring to the document library available on the company intranet.

Compliance with this document does not confer immunity from prosecution for breach of statutory or other legal obligations.

## BRIEF HISTORY

First published as T/SP/SSW22 Editorial update to reflect merger October 2002 Revised and reissued. Revised and Reissued as T/SP/SSW/22 Editorial update to comply with GRM	October 2001 November 2002 November 2003 June 2004 August 2004	EPSG/L01/283  EPSG/A03/10125 EPSG/T04/1209
Document revised to remove reference to Transco and replace with WWU Ltd.	May 2006	
Document revised to reflect WWU management structure, include IP pipelines and update letters	April 2013	

**KEY CHANGES** (Identify the changes from the previous version of this document)

Section	Amendments
1	Scope extended from any pipe operating above 7bar to above 2bar gauge
5 & 6	References added to T/PR/P/18
8	References added to wind turbine development near pipelines

## USE

This document is provided by Wales & West Utilities Limited for information and reference.

## MANDATORY AND NON-MANDATORY REQUIREMENTS

In this document:

**must:** indicates a mandatory requirement.

**should:** indicates best practice and is the preferred option. If an alternative method is used then a suitable and sufficient risk assessment must be completed to show that the alternative method delivers the same, or better, level of protection.

# **SPECIFICATION FOR SAFE WORKING AND DEVELOPMENT IN THE VICINITY OF PIPELINES AND ASSOCIATED INSTALLATIONS OPERATING ABOVE 2 BARG - REQUIREMENTS FOR THIRD PARTIES**

## **INTRODUCTION**

This specification is for issue to third parties carrying out work in the vicinity of high pressure gas pipelines (above 2 bar gauge) and associated installations and is provided to ensure that individuals planning and undertaking work take appropriate measures to prevent damage.

Any damage to a high-pressure gas pipeline or its coating can affect its integrity and can result in failure of the pipeline with potential serious hazardous consequences for individuals located in the vicinity of the pipeline if it were to fail. It is therefore essential that the procedures outlined in this document are complied with when working near to a high pressure, above 2 bar gauge, pipeline. If any work is considered by Wales & West Utilities to be in breach of the requirements stipulated in this document then the Wales & West Utilities responsible person will suspend the work until the non-compliances have been rectified.

The Pipelines Safety Regulations state that “No person shall cause such damage to a pipeline as may give rise to a danger to persons” (Regulation 15). Failing to comply with these requirements could therefore also result in prosecution by the Health and Safety Executive (HSE).

The requirements in this document are in line with the requirements of the IGE (Institution of Gas Engineers) recommendations IGE/SR/18 Edition 2 - Safe Working Practices To Ensure The Integrity Of Gas Pipelines And Associated Installations and the HSE’s guidance document HS(G)47 Avoiding Danger from Underground Services.

It is the responsibility of the third party to ensure that any work carried out also conforms with the requirements of the Construction and Design Management Regulations and all other relevant health and safety legislation.

**WHEN CARRYING OUT WORK IN THE VICINITY OF A HIGH PRESSURE PIPELINE  
FOLLOW THE FOLLOWING PROCESS**

**CONTACT WALES & WEST UTILITIES**

Contact Wales & West Utilities to obtain formal consent - Section 2 of this document.  
**Note:** at least 7 days' notice prior to commencement of the work is normally required



**CONSIDER SAFETY**

Consider the safety requirements - Section 3 of this document.



**INFORM Wales & West Utilities AND REQUEST PIPELINE LOCATION**

Inform Wales & West Utilities prior to carrying out work and arrange for Wales & West Utilities to locate the pipeline - Section 4 of this document  
**Note:** at least 7 days' notice is normally required



**OBSERVE RESTRICTIONS**

Observe Wales & West Utilities restrictions on the allowed proximity of mechanical excavators and other power tools and the measures to protect the pipeline from construction vehicles when carrying out the work – Sections 5, 6 and 7 of this document.  
**Note:** Wales & West Utilities may wish to supervise the work, consult Wales & West Utilities to confirm whether or not this is the case.



**SPECIFIC ACTIVITIES**

If work involves any of the following activities:

- No-Dig Techniques
- Increase in Cover
- Piling
- Demolition
- Hot Work
- Blasting
- Surface Mineral Extraction
- Deep Mining
- Landfilling
- Pressure Testing
- Seismic Surveys
- Wind Turbines

Comply with the requirements in Section 8 of this document



**CONSULT WALES & WEST UTILITIES**

Consult Wales & West Utilities prior to any backfilling over, alongside or under the pipeline and obtain Wales & West Utilities agreement to proceed. Normally Wales & West Utilities require 48 hours notice prior to backfilling - Section 9 of this document.

**IMPORTANT: This flowchart should be used in conjunction with the entire SSW22 document and not in isolation, AND if at any time during the works the pipeline is damaged even slightly then observe the precautions in Section 10 of this document.**

**IF IN DOUBT CONTACT Wales & West Utilities**

## **1. SCOPE**

This specification sets out the safety precautions and other conditions affecting the design, construction and maintenance of services, structures and other works in the vicinity of Wales & West Utilities pipelines and associated installations operating at pressures greater than 2 bar gauge, located in both negotiated easements (see Section 12), in public highways and within the wider area of interest around a pipeline.

## **2. FORMAL CONSENT**

High pressure pipelines are generally laid across country within an easement agreed with the landowner or within the highway.

As the required arrangements for working within an easement and working within the highway differ, this document has been structured to highlight the specific requirements for these two types of area where work may be carried out.

Generally, normal agricultural activities are not considered to affect the integrity of the pipeline, however consult Wales & West Utilities prior to undertaking deep cultivation in excess of 0.5m.

In all other cases no work shall be undertaken in the vicinity of the pipeline without the formal written consent of Wales & West Utilities.

Any documents, handed to contractors on site by Wales & West Utilities must be signed for by the site manager. Wales & West Utilities will record a list of these documents using the form in Appendix A, and the contractor should maintain a duplicate list.

### **2.1 Within an Easement**

The promoter of any works (see Section 12) within an easement must provide Wales & West Utilities with details of the proposed works including a method statement of how the work is intended to be carried out.

Work must not go ahead until formal written consent has been given by Wales & West Utilities. This will include details of Wales & West Utilities protection requirements, contact telephone numbers and the emergency telephone number.

On acceptance of Wales & West Utilities requirements the promoter of the works must give Wales & West Utilities 7 working days' notice, or shorter only if agreed with Wales & West Utilities, before commencing work on site.

### **2.2 Within the Highway**

Work must be notified to Wales & West Utilities in accordance with the requirements of The New Roads and Street Works Act (NRSWA) and HS(G)47.

The promoter of any works within the highway should provide Wales & West Utilities with details of the proposed works including a method statement of how the work is intended to be carried out. This should be submitted 7 working days before the planned work is to be carried out or shorter, only if agreed with Wales & West Utilities. If similar works are being carried out at a number of locations in close proximity a single method statement should be adequate.

Work should not go ahead until formal written consent has been given by Wales & West Utilities. This will include details of Wales & West Utilities' protection requirements, contact telephone numbers and the emergency telephone number.

### **2.3 Within the Area of Interest**

Certain other activities, such as the development of adjacent land with buildings, or other constructions which may have an impact on the safe operation of above 2 bar gauge pipelines, must also be notified to Wales & West Utilities, for example the construction of wind turbines, masts or aerials.

Developers should ensure early consultation with Wales & West Utilities in respect of such development, rather than relying on local authority planning consultation, which may lead to substantial late changes to design or constraints on the planned development.

## **3. HS&E CONSIDERATIONS**

### **3.1 Safe Control of Operations**

All working practices must be agreed by Wales & West Utilities prior to work commencing. All personnel working on site must be made aware of the potential hazard of the pipeline and the actions they should follow in case of an emergency. The Site Document Control Form (Appendix A) should be used to record the list of relevant documents that have been provided by Wales & West Utilities to the contractor.

### **3.2 Deep Excavations**

Special consideration should be given to the hazards associated with deep excavations. The HSE document CIS08 'Safety in Excavations' provides further guidance and is available on the HSE web site [www.hse.gov.uk](http://www.hse.gov.uk)

### **3.3 Positioning of Plant**

Mechanical excavators must not be sited or moved above the pipeline unless written authority has been given by the Wales & West Utilities responsible person.

Mechanical excavators must not dig on one side of the pipeline with the cab of the excavator positioned on the other side.

Mechanical excavators and other traffic must be positioned far enough away from the pipeline trench to prevent trench wall collapse.

### **3.4 General**

Activities associated with working in the vicinity of pipelines operating above 2 bar gauge may have impact on the safety of the general public, Wales & West Utilities staff and contractors, and may affect the local environment. Contractors must carry out suitable and adequate risk assessments prior to the commencement of work to ensure that all such issues are properly considered and risks mitigated.

## **4. PIPELINE LOCATING**

The third party should give 7 working days' notice (or shorter as agreed with Wales & West Utilities) to ensure that the pipeline is suitably located and marked out by Wales & West Utilities prior to the work commencing.

Prior to work commencing on site the pipeline must be located and pegged or suitably marked out by Wales & West Utilities personnel. In exceptional circumstances with the prior agreement of Wales & West Utilities the locating and marking out of the pipeline could be carried out by competent third parties on behalf of the contractor as long as Wales & West Utilities is assured of their competence and the procedures to be followed.

Safe digging practices, in accordance with HSE publication HS(G)47 should be followed as both direct and consequential damage to gas plant can be dangerous both to employees and to the general public.

Previously agreed working practices should be reviewed and revised based on current site conditions. Any changes must be agreed by the Wales & West Utilities responsible person.

The requirements for trial holes to locate the pipeline or determine levels at crossing points must be determined on site by the Wales & West Utilities responsible person.

The excavation of all trial holes must be supervised by the Wales & West Utilities responsible person.

## **5. SLABBING AND OTHER PROTECTIVE MEASURES**

No protective measures including the installation of concrete slab protection should be installed over or near to the Wales & West Utilities pipeline without the prior permission of Wales & West Utilities. Wales & West Utilities will need to agree the material, the dimensions and method of installation of the proposed protective measure. The method of installation must be confirmed through the submission of a formal written method statement from the contractor to Wales & West Utilities.

Where permanent slab protection is to be applied over the pipeline Wales & West Utilities should carry out a survey (Pearson or DCVG Survey) of the pipeline to check that there is no existing damage to the coating of the pipeline prior to the slab protection being put in place. In addition the pipeline records should be consulted to determine whether any other investigations or remedial works would be needed in advance of the slab construction, e.g. reference to T/PR/P/18. Wales & West Utilities must therefore be contacted prior to the laying of any slab protection to arrange this survey. The Safety precautions detailed in Sections 3 and 6 of this document should also be observed during the installation of the pipeline protection.

## **6. EXCAVATION**

### **6.1 In Proximity to a Pipeline in an Easement**

Third parties must not excavate unsupervised, with a powered mechanical excavator closer than 3 metres to the Wales & West Utilities located pipeline or with hand held power tools closer than 1.5 metres. Any fitting, attachment or connecting pipework on the pipeline must be exposed by hand. All other excavation must be by hand.

Consideration may be given to a relaxation of these limits by agreement with the Wales & West Utilities responsible person on site and only whilst he remains on site. In this case a powered mechanical excavator must not be allowed to excavate closer than 0.6 metres to the nearest part of the pipeline.

Where sufficient depth of cover exists, following evidence from hand dug trial holes, light tracked vehicles may be permitted to strip topsoil to a depth of 0.25 metres, using a toothless bucket.

No topsoil or other materials should be stored within the easement without the written permission of Wales & West Utilities.

No topsoil or materials should be stored over the pipeline.

No fires should be allowed in the easement strip or close to above ground gas installations.

After the completion of the work the level of cover over the pipeline should be the same as that prior to work commencing unless agreed otherwise with the Wales & West Utilities responsible person.

No new service shall be laid parallel to the pipeline within the easement. In special circumstances, and only with formal written agreement from Wales & West Utilities, this may be relaxed for short excursions where the service shall be laid no closer than 600 mm to the side of the pipeline.

Where work is being carried out parallel to the pipeline within or just alongside the easement a post and wire fence must be erected as a protective barrier between the works and the pipeline.



## **6.2 In Proximity to a Pipeline in the Highway**

Removal of the bituminous or concrete highway surface layer by mechanical means is permitted to depth of 300 mm, although the use of chain trenchers to do this shall not be permitted within 3 metres of the pipeline. The Wales & West Utilities responsible person may want to monitor this work.

Where the bituminous or concrete highway surface layer extends below 0.3 metres deep it should only be removed by handheld power assisted tools under the supervision of the Wales & West Utilities responsible person. In exceptional circumstances, and following a risk assessment, these conditions may be relaxed by the Wales & West Utilities responsible person.

Third parties should not excavate, unsupervised, with a powered mechanical excavator closer than 3 metres to the located Wales & West Utilities pipeline or with hand held power tools closer than 1.5 metres. Any fitting or attachment must be exposed by hand.

In special circumstances consideration may be given to a relaxation of these rules by agreement with the Wales & West Utilities responsible person on site and only whilst he remains on site only whilst he remains on site and only whilst he remains on site to supervise this work..

The use of 'No dig' techniques is covered in Section 8.1.

Any new service running parallel to the pipeline should be laid no closer than 600 mm to the pipeline (see Section 6.4).

## **6.3 Crossing Over a Pipeline**

Where a new service is to cross over the pipeline a clearance distance of 600 mm between the crown of the pipeline and underside of the service must be maintained. If this cannot be achieved the service must cross below the pipeline with a clearance distance of 600 mm.

In special circumstances this distance may be reduced at the discretion of the Wales & West Utilities responsible person on site.

## **6.4 Crossing Below a Pipeline**

Where a service is to cross below the pipeline a clearance distance of 600 mm between the crown of the service and underside of the pipeline should be maintained.

The exposed pipeline must be suitably supported. The Wales & West Utilities responsible person must be consulted and a stress analysis may be required in order to establish support requirements. The stress analysis should be carried out by individuals with demonstrated expertise in this area, Wales & West Utilities can be consulted for advice on suitable specialists. Wales & West Utilities may request a copy of the stress analysis to confirm its adequacy.

Specific additional constraints apply to Wales & West Utilities pipelines that fall under the requirements of T/PR/P/18.

All supports must be removed prior to backfilling.

The exposed pipelines must be protected by matting and suitable timber cladding.

## **6.5 Cathodic Protection**

Cathodic Protection is applied to all of Wales & West Utilities above 2 bar gauge buried steel pipelines and is a method of protecting pipelines with damaged coatings from corrosion by maintaining an electrical potential difference between the pipeline and anodes placed at strategic points along the pipeline.

Where a new service is to be laid and similarly protected, Wales & West Utilities will undertake interference tests to determine whether the new service is interfering with the cathodic protection of the Wales & West Utilities pipeline.

Should any cathodic protection posts or associated apparatus need moving to facilitate third party works reasonable notice, typically 7 days, should be given to Wales & West Utilities. Wales & West Utilities will undertake this work and any associated costs will be borne by the third party.

## **7. CONSTRUCTION TRAFFIC**

Where existing roads cannot be used construction traffic should ONLY cross the pipeline at previously agreed locations. All crossing points will be fenced on both sides with a post and wire fence and with the fence returned along the easement for a distance of 6 metres. The pipeline shall be protected at the crossing points by temporary rafts of either sleeper or reinforced concrete construction, constructed at ground level. The Wales & West Utilities responsible person will review ground conditions, vehicle types and crossing frequencies to determine the type and construction of the raft required.

Notices directing traffic to the crossing points should be erected.

## **8. SPECIFIC ACTIVITIES**

This section details the precautions that need to be taken when carrying out certain prescribed activities in the vicinity of the pipeline. Consult Wales & West Utilities if you are intending to undertake one of the listed prescribed activities and/or you require further advice on whether the work that you are intending to undertake has the potential to affect the pipeline.

### **8.1 No-Dig Techniques**

Where the contractor intends using no dig techniques then a formal method statement must be produced for all work that would encroach (either above or below ground) within the pipeline easement. This method statement must be formally agreed with Wales & West Utilities prior to the commencement of the work. Wales & West Utilities may wish to be present when the work is being carried out and must therefore be given adequate advance notice before the commencement of the work.

### **8.2 Increase in Cover**

A pipeline integrity assessment must be provided for situations involving a final cover depth exceeding 2.5 metres. This assessment should take due account of both soil 'dead' loading and ground settlement due to earthworks. Embankment design and construction over pipelines must give consideration to prevention of any instability. Expert advice may need to be sought which can be arranged through Wales & West Utilities.

### **8.3 Piling**

No piling will be allowed within 15 metres of a pipeline without an assessment of the vibration levels at the pipeline. The peak particle velocity at the pipeline should be limited to a maximum level of 75 mm/sec. In any event the ground vibration shall be monitored by the contractor and the results available to the Wales & West Utilities Responsible person at their request. A typical monitoring device would be the Vibrock V801 seismograph and tri-axial geophone sensor.

Where ground conditions are of submerged granular deposits of silt and sand, an assessment of the effect of vibration on settlement and liquefaction at the pipeline shall be made.

Expert advice may need to be sought which can be arranged through Wales & West Utilities.

### **8.4 Demolition**

No demolition should be allowed within 150 metres of a pipeline without an assessment of the vibration levels at the pipeline. The peak particle velocity at the pipeline must be limited to a maximum level of 75 mm/sec. In any event the ground vibration shall be monitored by the contractor and the results available to the Wales & West Utilities Responsible person at their request.

Where ground conditions are submerged granular deposits of silt or sand, an assessment of the effect of vibration on settlement and liquefaction at the pipeline shall be made.

Expert advice may need to be sought which can be arranged through Wales & West Utilities.

## **8.5 Blasting**

No blasting should be allowed within 250 metres of a pipeline without an assessment of the vibration levels at the pipeline. The peak particle velocity at the pipeline must be limited to a maximum level of 75 mm/sec. In any event the ground vibration must be monitored by the contractor and the results available to the Wales & West Utilities Responsible person at their request.

Where ground conditions are of submerged granular deposits of silt or sand, an assessment of the effect of vibration on settlement and liquefaction at the pipeline shall be made.

Expert advice may need to be sought which can be arranged through Wales & West Utilities.

## **8.6 Surface Mineral Extraction**

An assessment must be carried out on the effect of surface mineral extraction activity within 100 metres of a pipeline. Consideration should also be given to extraction around groundbeds and other pipeline associated plant and equipment.

Where the mineral extraction extends up to the pipeline easement, a stable slope angle and stand-off distance between the pipeline and slope crest must be determined by Wales & West Utilities. The easement strip should be clearly marked by a suitable permanent boundary such as a post and wire fence, and where appropriate, slope indicator markers shall be erected to facilitate the verification of the recommended slope angle as the slope is formed, by the contractor. The pipeline easement and slope needs to be inspected periodically to identify any signs of developing instability. This may include any change of slope profile including bulging, the development of tension cracks on the slope or easement, or any changes in drainage around the slope. The results of each inspection should be recorded.

Where surface mineral extraction activities are planned within 100 metres of the pipeline but do not extend up to the pipeline easement boundary, an assessment, by Wales & West Utilities must be made on whether the planned activity could promote instability in the vicinity of the pipeline. This may occur where the pipeline is routed across a natural slope or the excavation is deep. A significant cause of this problem is where the groundwater profile is affected by changes in drainage or the development of lagoons.

Where the extraction technique involves explosives the provisions of section 8.5 apply.

## **8.7 Deep Mining**

Pipelines routed within 1 km of active deep mining may be affected by subsidence resulting from mineral extraction. The determination of protective or remedial measures will normally require expert assistance, which can be arranged through Wales & West Utilities.

## **8.8 Landfilling**

The creation of slopes outside of the pipeline easements may promote instability within the vicinity of the pipeline. An assessment should therefore be carried out, by Wales & West Utilities, on the effect of any landfilling activity within 100 metres of a pipeline. The assessment is particularly important if landfilling operations are taking place on a slope in which the pipeline is routed.

## **8.9 Pressure Testing**

Hydraulic pressure testing will not be permitted within 8 metres of the pipeline unless suitable precautions have been taken against the effects of a burst. These precautions should include limiting of the design factor to 0.3 for the third party pipeline for a distance of 6 metres either side of the Wales & West Utilities pipeline, and the use of mill tested pipe or sleeving.

## **8.10 Seismic Surveys**

Wales & West Utilities must be advised of any seismic surveying work in the vicinity of pipeline that will result in Wales & West Utilities' pipeline being subjected to peak particle velocities in excess of 50 mm/sec. In any event the ground vibration near to the pipeline shall also be monitored by the contractor whilst the survey work is being carried out.

Where the peak particle velocity is predicted to exceed 50 mm/sec, the ground vibration should be monitored by the contractor and the results available to the Wales & West Utilities Responsible person at their request.

#### **8.11 Hot Work**

The Wales & West Utilities responsible person on site should supervise all welding, burning or other 'hot work' that takes place within the easement.

#### **8.12 Wind Turbines**

Wales & West Utilities must be advised of any planned development of wind turbines in the vicinity of an above 2 bar gas pipelines to ensure the development does not impact on the future safe operation of the pipeline. Industry guidance states that any wind turbine must be sited no closer than 1.5 times the proposed height of the turbine mast away from the nearest edge of the pipeline.

### **9. BACKFILLING**

Third parties must provide Wales & West Utilities with 7 days' notice, or shorter notice only if agreed with Wales & West Utilities, of the intent to backfill over, under or alongside the pipeline. This requirement should also apply to any backfilling operations alongside the pipeline within 3 metres of the pipeline. Any damage to the pipeline or coating must be reported to the Wales & West Utilities responsible person in order that damage can be assessed and repairs can be carried out.

**Minor damage to pipe coating and damage to test leads will normally be repaired by Wales & West Utilities free of charge.**

No backfilling should be undertaken without Wales & West Utilities agreement to proceed. When backfilling, the pipeline should be surrounded by at least 300mm of soft fill (i.e. stone dust) containing no stones, bricks, lumps of concrete, etc. The Wales & West Utilities responsible person will stipulate the necessary consolidation requirements.

If the pipeline has been backfilled without the knowledge of the Wales & West Utilities responsible person then he will require the material to be re-excavated in order to enable the condition of the pipeline coating to be confirmed.

### **10. ACTION IN THE CASE OF DAMAGE TO THE PIPELINE**

If the Wales & West Utilities pipeline is damaged, even slightly, and even if no gas leak has occurred then the following precautions must be taken immediately:-

- ◆ Shut down all plant and machinery and extinguish any potential sources of ignition.
- ◆ Evacuate all personnel from the vicinity of the pipeline.
- ◆ Notify Wales & West Utilities using the free 24 hour emergency telephone number **0800 111 999**<sup>\*1</sup>
- ◆ Notify the Wales & West Utilities responsible person or his office immediately using the contact telephone number provided.
- ◆ Ensure no one approaches the pipeline.
- ◆ Do not try to stop any leak.

<sup>1</sup> \* All calls are recorded and may be monitored

## 11. REFERENCES

NRSWA	New Roads & Street Works Act
HS(G)47	Avoiding Danger from Underground Services
IGE/SR/18	Safe Working Practices to Ensure the Integrity of Gas Pipelines and Associated Installations
T/PR/P/18	Working on Pipelines Containing Defective Girth Welds or Girth Welds of Unknown Quality
CIS08	Safety in Excavations (HSE document)

## 12. GLOSSARY OF TERMS

Contractor:	the person, firm or company with whom Wales & West Utilities enters into a contract to which this specification applies, including the Contractor's personal representatives, successors and permitted assigns.
Easement:	Easements are negotiated legal entitlements between Wales & West Utilities and landowner and allow Wales & West Utilities to lay, operate and maintain pipelines within the easement strip. Easement strips may vary in width typically between 6 and 25 metres depending on the diameter and pressure of the pipeline. Consult Wales & West Utilities for details of the extent of the easement strip where work is intended.
Liquefaction:	Liquefaction is a phenomenon in which the strength and stiffness of the soil is reduced by earthquake shaking or other rapid loading. Liquefaction occurs in saturated soils, that is, soils in which the space between individual particles is completely filled with water. When liquefaction occurs, the strength of the soil decreases and the ability of the soil to support pipelines or other components is reduced.
Pearson Survey:	a survey used for locating coating defects on buried pipeline services.
DCVG Survey:	Direct Current Voltage Gradient, a survey for locating and grading coating defects on buried pipeline service
Promoter of new works:	the person or persons, firm, company or authority for whom new services, structures or other works in the vicinity of existing Wales & West Utilities pipelines and associated installations operating above 7 bar gauge are being undertaken.
Wales & West Utilities responsible person:	the person or persons appointed by Wales & West Utilities with the competencies required to act as the Wales & West Utilities representative for the purpose of the managing the particular activity.
Wayleave:	general term which is considered equivalent to 'easement' in this document.

**APPENDIX A**

**SITE DOCUMENT CONTROL FORM - SAMPLE**

**Emergency Telephone No.                    0800 111 999\***  
**Plant Protection Telephone No.        02920278912**

**SITE DOCUMENT CONTROL FORM**

<b>Activity Reference:</b>	
<b>Activity Location:</b>	
<b>Site Manager:</b> <i>(name &amp; telephone number)</i>	
<b>Wales &amp; West Utilities Contact:</b> <i>(name &amp; telephone number)</i>	

**The following documents were issued to** *(individual's name)*  
..... **of**  
*(company name and address)*  
.....  
**by** *(Wales & West Utilities representative)*  
..... **on**  
*(date)*.....:-

**Documents:-**  
*(List of documents)*

---

**Signed :** *(by the recipient)*  
**Date of signature :**

**SITE DOCUMENT CONTROL FORM**

Emergency Telephone No. **0800 111 999\***

Plant Protection Telephone No. 02920 278912

**SITE DOCUMENT CONTROL FORM**

**Activity Reference:**

**Activity Location:**

**Site Manager:**

*(name & telephone number)*

**Wales & West Utilities Contact:**

*(name & telephone number)*

**The following documents were issued to** (Individuals Name)

.....**of**  
*(company name and address)*

**by** *(Wales and West Utilities representative)*

.....**on**  
*(date)* ..... :-

**Documents:-**

**Signed :**

**Date of signature :**

## ENDNOTE

### Comments

Comments and queries regarding the technical content of this document should be directed to:

Asset Management & HSE Dept  
Wales & West Utilities Ltd  
Wales & West House  
Spoooner Close  
Celtic Springs  
Coedkernew  
Newport  
NP10 8FZ.

### © Wales & West Utilities

This document is copyright and must not be reproduced in whole or in part by any means without the approval in writing of Wales & West Utilities.



# Wales & West Utilities Limited

## General Conditions to be observed for the Protection of Apparatus and the Prevention of Disruption to Gas Supplies.

General conditions affecting the design, construction or maintenance of services and/or structures or other works in the vicinity of Wales & West Utilities (WWU) plant, pipelines and associated installations:

These general conditions apply only to the gas apparatus and pipes operated by WWU. It is possible that there may be other gas transporters with apparatus in the vicinity, therefore you should ensure that you have made enquiries of them and have complied with their requirements.

### 1. GRAPHIC REPRESENTATION OF GAS MAINS

Any plans supplied or marked up by WWU will indicate the **APPROXIMATE** location of its apparatus. This information is provided as a general guide only; its accuracy cannot be guaranteed and is given without obligation or warranty. Service pipes are not shown but their presence should be anticipated. No liability whatsoever is accepted by WWU, its agents or servants for any error, omission, discrepancy or deviation. Plans on site should be current, i.e. no older than 28 days from the date of issue. Gas pipes owned by other Gas Transporters, or otherwise privately owned, may be present in this area (pink areas indicated on our plans). Information with regard to such pipes should be obtained from the relevant owners.

Should you require assistance on site locating WWU apparatus, please contact our Plant Protection Team on **02920 278912**.

### 2. METHODS OF WORKING

The following methods of work shall not normally be permitted within the limits of distance indicated (relative to the established pipe position). Any variances must have consent from WWU before works commence on site:

Mechanical Excavation	<b>3m (1m for low pressure mains)</b>	Hydraulic Testing	<b>8 m</b>
Piling / Pile removing / Boring	<b>15m</b>	Welding or other hot works*	<b>15m</b>
Directional Drill Operations	<b>15m</b>	Explosives	<b>250m</b>

\* NOTE: Welding or other hot works involving naked flames shall be carried out at a safe distance to the satisfaction of a WWU Engineer. A check should be made prior to the commencement of works, to ensure a gas free atmosphere exists. It is also necessary to monitor the atmosphere at regular intervals for the duration of the works. In no case shall such activities take place in any Wales & West Utilities Easement without the written consent and in the presence of a WWU representative.

WWU must be consulted prior to carrying out any excavation work within **10m** of any above or below ground gas installations or pipeline. No excavation works may commence within **50m** of a High Pressure or Very High Pressure Pipeline unless the pipeline has been located by tracing and its precise route identified.

In addition to the above methods of working, WWU must be contacted prior to any External Wall Installation (EWI) schemes, proposed solar farms and wind turbine installations.

No work shall be undertaken near, nor heavy plant or equipment moved over, any gas pipeline or apparatus until all of the conditions specified by WWU have been complied with.

Where WWU have apparatus in the vicinity of your work, any damage to it could have serious consequences. In view of this and in the interests of safety, a meeting should be arranged before the commencement of work on site between WWU representatives, representatives of the promoting authority, the contractors and any other interested parties. At this meeting the suggested program of site works and plant safety should be discussed. It is essential that this meeting is convened well in advance of commencement on site. Access to WWU plant and facilities for inspection by WWU staff must not be affected. Where formal consent has been given, **A MINIMUM OF SEVEN DAYS NOTICE IS REQUIRED** before carrying out work in WWU easements, or the appropriate notice under the New Roads & Street Works Act (NRSWA) where existing plant is situated within the public highway.

Further guidance can also be sought from the document **HS(G)47 – Avoiding Danger from Underground Services** from the HSE website.

### 3. PROXIMITY OF OTHER PLANT

A minimum clearance of **600 millimetres (mm)** should be allowed between all plant being installed and an existing gas main operating above 2 bar medium pressure (MP), whether the adjacent plant is parallel to or crossing the gas pipe. For mains operating at MP or below, this distance can be reduced to 300mm. **NO APPARATUS SHOULD BE LAID OVER AND ALONG THE LINE OF A GAS PIPE, IRRESPECTIVE OF CLEARANCE.**

No manhole or chamber shall be built over or around a gas pipe and no work should be carried out which results in a reduction of cover or protection over a pipe without consultation with and the agreement of WWU staff.

### 4. PROTECTION

Where any works cross or run in close proximity to WWU apparatus, periodic visits must be made by a WWU engineer. His requests for protection or support to the apparatus shall be immediately observed.

Suitably designed crossing points are to be constructed to the satisfaction of a WWU Engineer. These crossing points shall be clearly indicated by the erection of bunting and crossings at other places should be prevented.

Backfill material adjacent to WWU apparatus shall be soft fill or sand, containing no stones, bricks, or lumps of concrete etc., placed to a minimum 150mm around the mains and is to be well compacted by hand. No power consolidation shall take place above the main until 300mm of soft fill has been compacted by hand.

# Wales & West Utilities Limited

## 5. DAMAGE TO COATINGS

Where a gas pipe is coated with special wrapping and this is damaged, even to a minor extent, WWU must be notified so that repairs can be made to prevent future corrosion and subsequent leakage. **WHERE MINOR DAMAGE TO COATING IS REPORTED TO WWU PRIOR TO BACKFILL, THE NECESSARY REPAIR WILL BE MADE FREE OF CHARGE.**

## 6. CATHODIC PROTECTION

Where WWU apparatus is cathodically protected either by sacrificial anode or impressed current systems and where new apparatus is to be laid and is to be similarly protected, WWU will require to carry out interaction tests to determine whether its own system is adversely affected. The cost of any mutually agreed remedial action will be recharged to the authority installing the new apparatus. If any bond wires, test leads etc., used in connection with cathodic protection systems are damaged or found to be in poor condition, broken or disconnected, WWU must be notified prior to backfilling so that a repair can be made.

## 7. HOT WORKS

Even when a gas free atmosphere exists care must be taken when carrying out hot works in close proximity to gas plant in order to ensure that no damage occurs. Particular care must be taken to avoid damage by heat or naked flames to plastic gas pipes or to the protective coatings on other pipes.

## 8. DEMOLITION

Live gas services must be disconnected **PRIOR** to demolishing any property, arrangements must be made for WWU to check for the presence of any live gas services.

## 9. TREE PLANTING

WWU must be contacted prior to all tree-planting works above or near our apparatus. Further information can then be made available.

## 10. DEEP EXCAVATIONS

Any work involving deep excavations (1.5m or more) will be subject to the "Model Consultative Procedure for Pipeline Construction involving Deep Excavations". This may require the diversion of WWU apparatus prior to the commencement of your works. Detailed plans and cross sections will be required in order to determine the effect of these works on WWU apparatus.

## 11. RENEWABLE ENERGY INSTALLATIONS

Wind Turbines – WWU must be advised of any planned development of wind turbines in the vicinity of an above 2 bar gas pipelines to ensure the development does not impact on the future safe operation of the pipeline. Industry guidance states that any wind turbine must be sited no closer than 1.5 times the proposed height of the turbine mast away from the nearest edge of the pipeline.

Solar Farms – WWU must be contacted regarding planned solar farms being considered in the vicinity of WWU gas pipelines.

EWI – WWU must be contacted regarding any EWI scheme to ensure the scheme does not impact upon WWU's apparatus.

## 12. LEAKAGE FROM GAS MAINS OR SERVICES

If damage or leakage is caused or an escape of gas is smelt or suspected the following action should be taken at once:

- Remove all personnel from the immediate vicinity of the escape.
- Inform the 24hr Gas Emergency Service on **0800 111 999**
- Prevent any approach by the public, prohibit smoking, and extinguish all naked flames or other sources of ignition for at least 15 metres from the leakage. Do not operate any electrical switches in the vicinity of the escape.
- Assist gas personnel, Police and/or Fire Services as requested.

**IN THE EVENT OF A LEAK, OBSERVE THE ABOVE BUT DO NOT ATTEMPT TO SEAL THE LEAK  
REMEMBER - IF IN DOUBT; SEEK ADVICE FROM WWU**

## 13. BUILDING PROXIMITIES

There are minimum proximity distances for buildings from WWU mains depending on both the operating pressure and the material of the main. Advice should be sought from WWU prior to building works taking place to confirm these distances. For High Pressure pipelines you must seek further guidance from the HSE and Local Authority Planning team regarding their PADHI distances regarding building proximities as these may be in addition to WWU proximity distances for a pipeline.

Temporary buildings should not be placed above any gas pipe or within 3.0 metres of mains operating above 75mbar (medium, intermediate and high pressure mains) during construction activities and in no circumstances should permanent structures be built over any pipe transporting gas.

## 14. SITE RESPONSIBILITIES

All costs incurred by WWU for the repair of direct or consequential damage to gas plant will be rechargeable (with the exception of paragraph 5). WWU reserves the right to divert any affected apparatus or alternatively specify suitable protection of its apparatus. If proved necessary during the course of site works, the cost of which will be chargeable.

The above requirements do not relieve you of the responsibility of taking all precautions necessary to safeguard the Company's plant and to avoid risk to persons and property. The persons for whom the works are being undertaken, their servants, agents and contractors shall indemnify WWU servants, agents and contractors against any loss, damage, expenses, claims and actions incurred or brought against Wales & West Utilities, its servants, agents and contractors in consequence of the provision of these works and activities associated therewith or ancillary thereto.

## KEY TO MAPS

<b>LP</b>	Low Pressure	<b>CI</b>	Cast Iron
<b>MP</b>	Medium Pressure	<b>SI</b>	Spun Iron
<b>IP</b>	Intermediate Pressure	<b>DI</b>	Ductile Iron
<b>HP</b>	High Pressure	<b>PE</b>	Polyethylene
		<b>ST</b>	Steel

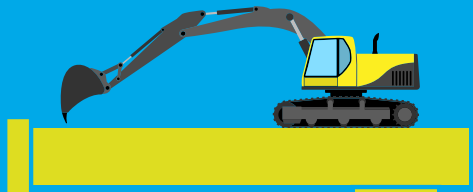

We're here to  
**help**

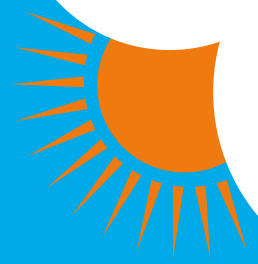

Dial  
before  
you dig

We need  
**10 days'**  
notice

Every day, underground gas pipes get damaged by people digging without knowing what's below. This can be catastrophic. It might cause serious injury to you and others around you. The costs of repair, fines and fees can be huge. Your project will be delayed and your reputation damaged.

We have designed this leaflet to help you dig safely. And the first thing to do – long before you start work – is call us.

What's the number?  
**029 2027 8912**

**?** Need help or advice?  
Call our **Plant Protection** team on  
**029 2027 8912**  
or email **dig@wwutilities.co.uk**

**!** Smell gas?  
Call the **Gas Emergency Service** on  
**0800 111 999**.

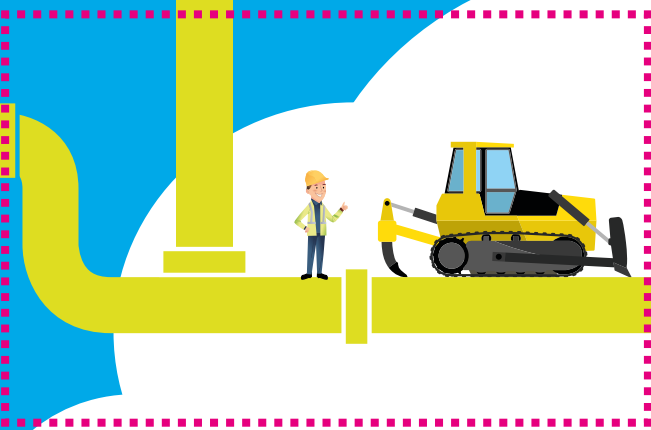
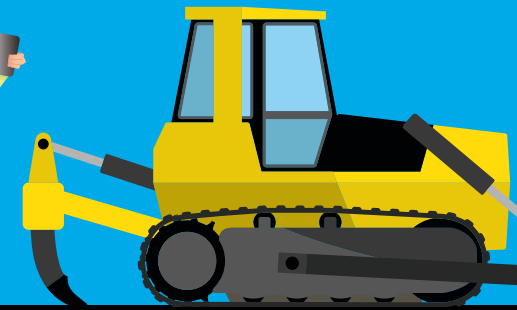

CARD POSITION (DO NOT PRINT)



- [dig@wwutilities.co.uk](mailto:dig@wwutilities.co.uk)
- 029 2027 8912
- [www.wwutilities.co.uk](http://www.wwutilities.co.uk)
- [facebook.com/wwutilities](https://facebook.com/wwutilities)
- @WWUtilities



Dial  
Investigate  
Go ahead

YOUR GAS EMERGENCY  
AND PIPELINE SERVICE



# Can you DIG it?

We bring the gas to homes and businesses across Wales and the south west of England. We invest money, time and effort every year to make sure our pipelines are protected – but the biggest danger to our network is you.

## D is for Dial

**Digging can be dangerous. Hit a gas pipe and you might cause a gas leak, a fire or explosion.**

So phone us first on **029 2027 8912** or email **dig@wwutilities.co.uk**

- You can find out where our pipes are.
- You need to give us 10 working days' notice before you start working.



## I is for Investigate

**It's the only way to stay safe**

- Before you start work, you must get a copy of our up-to-date gas plans and General Conditions and keep them with you on site.
- Use our online mapping service to find the mains pipes under your land.
- Working near a medium-, or intermediate- or high-pressure gas pipe? You might need a site visit – call us so we can arrange it.
- Plan ahead – we need at least 10 days' notice for a site visit.
- You'll also need our publication 'SSW22 Safe working in the vicinity of high-pressure pipelines and associated installations'.
- Remember, you can't work on a Wales & West Utilities wayleave or easement (land which we have rights over to maintain our gas network) without written permission.
- And you can't work near or move heavy equipment over any gas pipeline until all our conditions have been met and we agree your method of working.
- Watch the video on our website to find out more.



## G is for Go ahead

- Make sure you have our up-to-date gas plans on site.
- Need extra advice? Call our Plant Protection team on **029 2027 8912** or email **dig@wwutilities.co.uk**
- Use cable- and pipe-locating devices.
- Use safe digging practices, taking every precaution to avoid damaging gas pipes, damaging yourself and damaging your bank balance. You will be billed for any costs if something goes wrong.
- If in doubt, phone us again. We're happy to help.

We need  
**10 days'**  
notice



## Smell gas?

**Our Gas Emergency Service is on call 24 hours a day, seven days a week, 365 days a year.**

If you cause a gas leak, or think the network might be leaking, call the Gas Emergency Service immediately on **0800 111 999**.

- Get everyone away from the leak.
- Ask everyone in nearby buildings to leave until we're sure it's safe.
- Put out all naked flames and other sources of ignition and make sure no one smokes within 15 metres of the leak.
- Don't try to fix the leak by filling the hole, as gas may enter buildings.
- Don't try to operate any valves.
- Don't let anyone go near the leak.
- Help our engineers, the police or fire services if they ask.



Not Affected Utilities

## Utility Solutions GDC Requests

---

**From:** Christopher James <Christopher.James2@swansea.gov.uk> on behalf of street lighting <streetlighting@swansea.gov.uk>  
**Sent:** 05 December 2022 19:41  
**To:** Utility Solutions GDC Requests  
**Subject:** RE: Plant Enquiry - 115410 - Site near Rhydypany Road, Felindre, Swansea - Please respond by 06/12/2022

Good afternoon

Our records show that we have no assets within the boundaries of the enquiry.

Please note that the records may be incomplete and further investigation may be required on site to locate assets. The results of this enquiry have been provided for the sole use of the enquirer and no other party. City and County of Swansea accept no liability (except insofar as liability under any statute that cannot be excluded) arising in respect thereof or in any other way for errors or omissions including responsibility to any person by reason of negligence. If in doubt, please contact Swansea Highways on 01792 843330 or email [highways@swansea.gov.uk](mailto:highways@swansea.gov.uk) before work commences to arrange a site visit.

Kind Regards



Cyngor **Abertawe**  
**Swansea** Council

**Chris James**

*Uwch Dechnegydd Cynnal a Chadw - Goleuadau Stryd*  
Senior Maintenance Technician - Street Lighting

☎ 01792 841661

✉ [christopher.james2@swansea.gov.uk](mailto:christopher.james2@swansea.gov.uk)

✉ [christopher.james2@abertawe.gov.uk](mailto:christopher.james2@abertawe.gov.uk)

---

**From:** Utility Solutions GDC Requests <requests.utilitysolutions@atkinsglobal.com>

**Sent:** 05 December 2022 05:29

**To:** Sharron Murnieks <Sharron.Murnieks@swansea.gov.uk>; Drainage Coastal <DrainageCoastal@swansea.gov.uk>; street lighting <streetlighting@swansea.gov.uk>

**Subject:** Plant Enquiry - 115410 - Site near Rhydypany Road, Felindre, Swansea - Please respond by 06/12/2022

**CAUTION:** External email - Do not click links/open attachments unless you recognise the sender and know the content is safe

Our Reference: 115410

Site Name: Site near Rhydypany Road, Felindre, Swansea

Works Description: Building works (low rise) including tree planting and Installation of fencing, barriers, bollards, signage. Other (please state in Additional Works Description)

Site Grid References: 265249 200946,265428 201045,264081 200648,265375 201253,264083 200639

To whom it may concern,

Please find enclosed a plant enquiry for your attention.

**We request plans showing the location of your company's affected plant in relation to the [entire site area shown within the boundary on the attached map](#). Grid references and postcodes relative to the site boundary are provided on the attached map to help you locate the site.**

**From:** Charlie Geach <Charlie.Geach@swansea.gov.uk>  
**Sent:** 05 December 2022 14:55  
**To:** Utility Solutions GDC Requests  
**Cc:** Sharron Murnieks  
**Subject:** Plant Enquiry - 115410 - Site near Rhydypany Road, Felindre, Swansea  
**Attachments:** 115410-Map.pdf

Dear Sir/Madam

**HEALTH AND SAFETY AT WORK ACT 1974 - HG(G)47**  
**NEW ROAD AND STREET WORKS ACT 1991**  
**SECTION 79(3)**

**LOCATION:-** Site near Rhydypany Road, Felindre, Swansea

I refer to your correspondence giving notice of your proposed works at the above location.

No traffic signal plant is affected within the area shown



Cofion Gorau / Kind Regards  
**Charlie Geach - AppIHE**  
Prentis Peiriannydd - Telemateg  
Apprentice Engineer - Telematics

☎ 07970 154500

✉ [charlie.geach@abertawe.gov.uk](mailto:charlie.geach@abertawe.gov.uk)

✉ [charlie.geach@swansea.gov.uk](mailto:charlie.geach@swansea.gov.uk)

*Croesewir gohebiaeth yn y Gymraeg a byddwn yn ymdrin â gohebiaeth Gymraeg a Saesneg i'r un safonau ac amserlenni.*

*We welcome correspondence in Welsh and will deal with Welsh and English correspondence to the same standards and timescales*

\*\*\*\*\*

Mae'r e-bost hwn ac unrhyw ffeiliau a drosglwyddir gydag ef yn gyfrinachol ac at ddefnydd yr unigolyn neu'r corff y cyfeiriwyd hwy atynt yn unig. Os ydych wedi derbyn yr e-bost hwn drwy gamgymeriad, dylech hysbysu'r gweinyddydd yn y cyfeiriad canlynol:  
[gweinyddydd@abertawe.gov.uk](mailto:gweinyddydd@abertawe.gov.uk)

Bydd yr holl ohebiaeth a anfonir at y Cyngor neu ganddo yn destun cofnodi a/neu fonitro yn unol â'r ddeddfwriaeth berthnasol

Croesewir gohebiaeth yn y Gymraeg a byddwn yn ymdrin â gohebiaeth Gymraeg a Saesneg i'r un safonau ac amserlenni.

This e-mail and any files transmitted with it are confidential and intended solely for the use of the individual or entity to whom they are addressed. If you have received this e-mail in error, please notify the administrator on the following address: [administrator@swansea.gov.uk](mailto:administrator@swansea.gov.uk)

You recently requested information pertaining to the above location and in relation to CityFibre Holdings Ltd plant.

Reference bcb74c5b-0776-4220-ab9d-0e87ae13a1b4

User: User

Title: 115410

Comment: 20221205055648123

Please find attached a plan of the area of your interest that may contain plant which may be affected by your proposed works.

The validity of this response is 6 weeks, after such time a new enquiry would need to be made.

Please see the points of contact below if they are required:

Plant Enquiries

Rutherford House

Birchwood Park

Warrington

WA3 6ZH

asset.team@cityfibre.com

Please quote the Reference ID in the subject line in any correspondence.

Please be aware that all information included in this eMap is the property of the sender and subject to copyright.

It is illegal to copy or send this information to any third party without the permission of the sender.

---

[CityFibre]<





bitmap\_layout select\_raster

## LEGEND

- EXISTING PLANT
- EXISTING PLANT

bitmap\_layout select\_raster

Head Office  
CityFibre Holdings Ltd  
15 Bedford Street,  
London,  
WC2E 9HE

Tel: 0845 293 0774  
Web: www.cityfibre.com

Asset Office  
CityFibre Holdings Ltd,  
Rutherford House,  
Birchwood,  
Warrington,  
WA3 6ZH

Email: asset.team@cityfibre.com

### Disclaimer:

Information shown on this plan is for general guidance only. No warranty is made as to its accuracy. This plan must not be solely relied upon in the event of excavation or other works being carried out in the vicinity of Cityfibre plant. No liability of any kind is accepted by Cityfibre, its agents or servants for any error, omission, discrepancy or deviation. This information is valid for the date printed.

Project

Plant Enquiry

Drawing

Existing Plant

Drawn by:

smallworld

Date: 05/12/2022

Drawing No.

CFH\_EP\_000001

Revision

001

Scale: 1:2500

A4

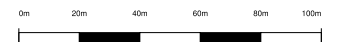



bitmap\_layout select\_raster

## LEGEND

- EXISTING PLANT
- EXISTING PLANT

bitmap\_layout select\_raster

Head Office  
CityFibre Holdings Ltd  
15 Bedford Street,  
London,  
WC2E 9HE

Tel: 0845 293 0774  
Web: www.cityfibre.com

Asset Office  
CityFibre Holdings Ltd,  
Rutherford House,  
Birchwood,  
Warrington,  
WA3 6ZH

Email: asset.team@cityfibre.com

### Disclaimer:

Information shown on this plan is for general guidance only. No warranty is made as to its accuracy. This plan must not be solely relied upon in the event of excavation or other works being carried out in the vicinity of Cityfibre plant. No liability of any kind is accepted by Cityfibre, its agents or servants for any error, omission, discrepancy or deviation. This information is valid for the date printed.

### Project

Plant Enquiry

### Drawing

Existing Plant

### Drawn by:

smallworld

Date: 05/12/2022

### Drawing No.

CFH\_EP\_000001

### Revision

001

Scale: 1:2500

A4

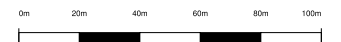



bitmap\_layout select\_raster

## LEGEND

- EXISTING PLANT
- EXISTING PLANT

bitmap\_layout select\_raster

Head Office  
CityFibre Holdings Ltd  
15 Bedford Street,  
London,  
WC2E 9HE

Tel: 0845 293 0774  
Web: www.cityfibre.com

Asset Office  
CityFibre Holdings Ltd,  
Rutherford House,  
Birchwood,  
Warrington,  
WA3 6ZH

Email: asset.team@cityfibre.com

### Disclaimer:

Information shown on this plan is for general guidance only. No warranty is made as to its accuracy. This plan must not be solely relied upon in the event of excavation or other works being carried out in the vicinity of Cityfibre plant. No liability of any kind is accepted by Cityfibre, its agents or servants for any error, omission, discrepancy or deviation. This information is valid for the date printed.

Project

Plant Enquiry

Drawing

Existing Plant

Drawn by:

smallworld

Date: 05/12/2022

Drawing No.

CFH\_EP\_000001

Revision

001

Scale: 1:2500

A4

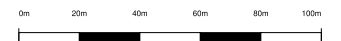



bitmap\_layout select\_raster

## LEGEND

- EXISTING PLANT
- EXISTING PLANT

bitmap\_layout select\_raster

Head Office  
CityFibre Holdings Ltd  
15 Bedford Street,  
London,  
WC2E 9HE

Asset Office  
CityFibre Holdings Ltd,  
Rutherford House,  
Birchwood,  
Warrington,  
WA3 6ZH

Tel: 0845 293 0774  
Web: www.cityfibre.com

Email: asset.team@cityfibre.com

**Disclaimer:**

Information shown on this plan is for general guidance only. No warranty is made as to its accuracy. This plan must not be solely relied upon in the event of excavation or other works being carried out in the vicinity of Cityfibre plant. No liability of any kind is accepted by Cityfibre, its agents or servants for any error, omission, discrepancy or deviation. This information is valid for the date printed.

Project

Plant Enquiry

Drawing

Existing Plant

Drawn by:

smallworld

Date: 05/12/2022

Drawing No.

CFH\_EP\_000001

Revision

001

Scale: 1:2500

A4

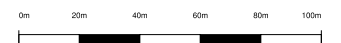

yrdd

EI  
Sub  
Sta



bitmap\_layout select\_raster

## LEGEND

- EXISTING PLANT
- EXISTING PLANT

bitmap\_layout select\_raster

Head Office  
CityFibre Holdings Ltd  
15 Bedford Street,  
London,  
WC2E 9HE  
Tel: 0845 293 0774  
Web: www.cityfibre.com

Asset Office  
CityFibre Holdings Ltd,  
Rutherford House,  
Birchwood,  
Warrington,  
WA3 6ZH  
Email: asset.team@cityfibre.com

**Disclaimer:**

Information shown on this plan is for general guidance only. No warranty is made as to its accuracy. This plan must not be solely relied upon in the event of excavation or other works being carried out in the vicinity of Cityfibre plant. No liability of any kind is accepted by Cityfibre, its agents or servants for any error, omission, discrepancy or deviation. This information is valid for the date printed.

**Project**

Plant Enquiry

**Drawing**

Existing Plant

**Drawn by:**

smallworld

Date: 05/12/2022

**Drawing No.**

CFH\_EP\_000001

**Revision**

001

Scale: 1:2500

A4

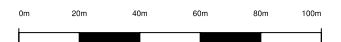

**From:** plantenquiry@gtc-uk.co.uk  
**Sent:** 05 December 2022 13:50  
**To:** Utility Solutions GDC Requests  
**Subject:** GTC Plant Enquiry - Ref- 2985632  
**Attachments:** 2985632.png

## **GTC Apparatus Not Found In Search Area**

**Our Plant Enquiry Service Ref: 2985632**  
**Your Enquiry Ref: LM 115410/DK**

Dear Chrissy,

Thank you for your enquiry concerning apparatus in the vicinity of your proposed work. GTC can confirm that we have no apparatus in the vicinity but please note that other asset owners may have and ensure all utility owners have been consulted. For your records, the search area is shown in the attached map.

Please note our assets now include those owned and operated by:

- GTC Pipelines Limited
- Independent Pipelines Limited
- Quadrant Pipelines Limited
- Electricity Network Company Limited
- Independent Power Networks Limited
- Independent Water Networks Limited
- Open Fibre Networks Limited
- Independent Community Heating Limited

If you have any queries or require any further information please do not hesitate to contact us.

**Your sincerely,**

GTC Plant Enquiry Service.

GTC  
Synergy House  
Woolpit Business Park  
Woolpit  
Bury St Edmunds  
Suffolk, IP30 9UP  
Tel: 01359 240363  
plant.enquiries@gtc-uk.co.uk

**NOTE:**

This E-Mail originates from GTC, Synergy House, Woolpit Business Park, Woolpit, Bury St Edmunds, Suffolk, IP30 9UP  
VAT Number: GB688 8971 40. Registered No: 029431.

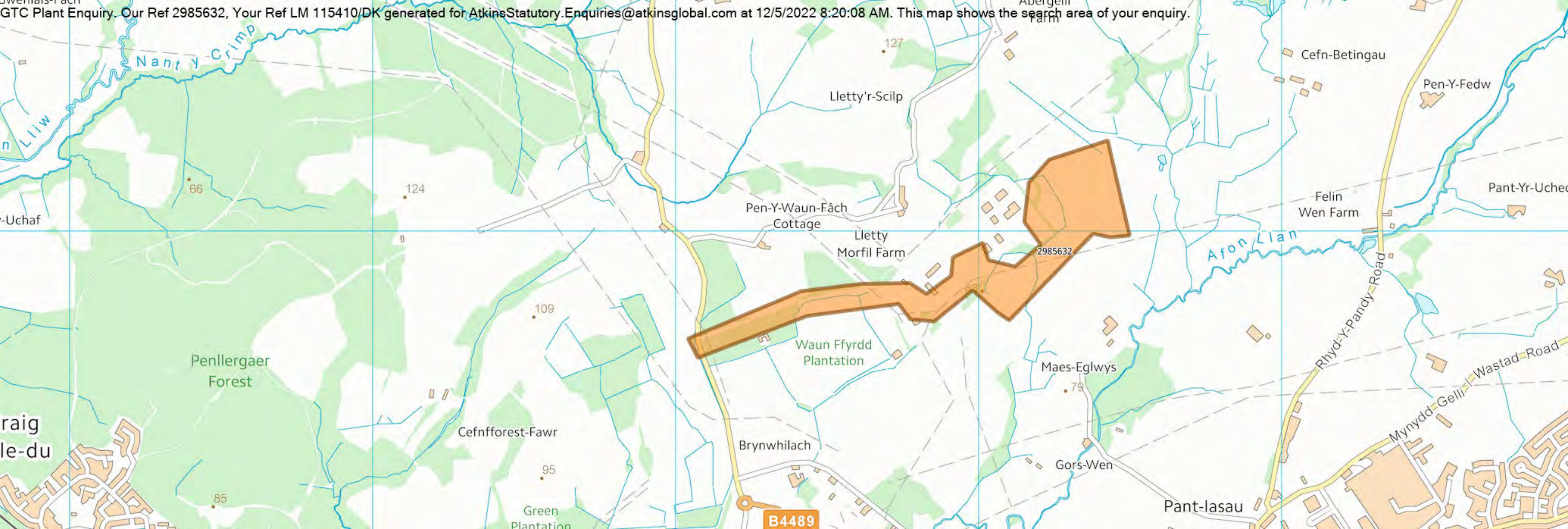

## Utility Solutions GDC Requests

---

**From:** Plantenquiries <Plantenquiries@instalcom.co.uk>  
**Sent:** 05 December 2022 19:13  
**To:** Utility Solutions GDC Requests  
**Subject:** E12-22-1081 RE: Plant Enquiry - 115410 - Site near Rhydypany Road, Felindre, Swansea - Please respond by 06/12/2022

Dear Sir or Madam,

Thank you for your plant enquiry below.

We can confirm that Lumen Technologies (formerly CenturyLink Communications UK Limited, Level 3, Global Crossing (Uk) Ltd, Global Crossing PEC, Fibernet UK Ltd and Fibrespan Ltd) do not have any apparatus within the indicated works area.

Instalcom responds to plant enquiries for all of the above and therefore you only need send one plant enquiry to cover all of these companies.

**Please note that this response is only valid for 3 months. If your works do not commence within this time period, please resubmit your plant enquiry for assessment before any works commence.**

Regards

Plant Enquiries Dept  
Instalcom Limited  
Borehamwood Ind. Park  
Rowley Lane  
Borehamwood  
WD6 5PZ

Office: +44 (0)208 731 4613  
Fax: +44 (0)208 731 4601  
Email: [plantenquiries@instalcom.co.uk](mailto:plantenquiries@instalcom.co.uk)  
Web: <http://www.instalcom.co.uk>



---

**From:** requests.utilitysolutions@atkinsglobal.com <requests.utilitysolutions@atkinsglobal.com>  
**Sent:** 05 December 2022 05:27  
**Cc:** requests.utilitysolutions@atkinsglobal.com  
**Subject:** Plant Enquiry - 115410 - Site near Rhydypany Road, Felindre, Swansea - Please respond by 06/12/2022



Our Ref: 27820377      LM 115410/DK

Monday, 05 December 2022

Ben Evans  
The Hub, 500 Park Avenue, Aztec West  
Almondsbury  
Bristol  
BS32 4RZ

**National Gas Emergency Number:  
0800 111 999\***

\*Available 24 hours, 7 days/week.  
Calls may be recorded and monitored.  
[www.nationalgrid.com](http://www.nationalgrid.com)

Asset Protection  
Gas Transmission  
National Grid  
Warwick  
CV34 6DA  
Email: [assetprotection@nationalgrid.com](mailto:assetprotection@nationalgrid.com)

## National Grid Gas – Site Visit Letter

Dear Sir/ Madam,

An assessment has been carried out with respect to National Grid Gas Transmission plc's apparatus and the proposed work location. Based on the location entered into the system for assessment the area has been found to be within the High Risk zone from National Grid Gas Transmission plc's apparatus and you **MUST NOT PROCEED** without further assessment. A member of our Operations Team will contact you to arrange a site visit, this contact will be made within 7 working days. Please note that, for future enquiries, we do require 10 working days' notice prior to works commencing in order to complete a full safety assessment.

Please ensure that the start date you have given for your work is as accurate as possible. We require 10 working days notice to be able to schedule most visits. If the date you have given us changes, it may not be possible for us to amend it at short notice

It is **YOUR** responsibility to take into account whether you are required to or would benefit from referring to the HSE Land Use Planning App (LUP), available from HSE's website. (Please note for some works this is a requirement for them to take place) More information on the LUP is available at <https://www.hse.gov.uk/landuseplanning/>

Please note this response and any attached map(s) are valid for 28 days.

Yours sincerely

**Asset Protection Team**

## Your Responsibilities and Obligations

The "Assessment" Section below outlines the detailed requirements that must be followed when planning or undertaking your activities at this location.

It is your responsibility to ensure that the information you have submitted is accurate and that all relevant documents including links are provided to all persons (either direct labour or contractors) working for you near National Grid Gas Transmission plc's apparatus, e.g. as contained within the Construction (Design and Management) Regulations.

This assessment solely relates to National Grid Gas Transmission plc (NGGT)

This assessment does **NOT** include:

- National Grid's legal interest (easements or wayleaves) in the land which restricts activity in proximity to National Grid's assets in private land. You must obtain details of any such restrictions from the landowner in the first instance and if in doubt contact Asset Protection.
- Recently installed apparatus
- Apparatus owned by other organisations, e.g. Cadent, National Grid Electricity Transmission plc, other gas distribution operators, local electricity companies, other utilities, etc.

It is **YOUR** responsibility to take into account whether the items listed above may be present and if they could be affected by your proposed activities.

This communication does not constitute any formal agreement or consent for any proposed development work; either generally or with regard to National Grid Gas Transmission plc easements or wayleaves nor any planning or building regulations applications.

National Grid Gas Transmission plc or their agents, servants or contractors do not accept any liability for any losses arising under or in connection with this information. This limit on liability applies to all and any claims in contract, tort (including negligence), misrepresentation (excluding fraudulent misrepresentation), breach of statutory duty or otherwise. This limit on liability does not exclude or restrict liability where prohibited by the law nor does it supersede the express terms of any related agreements.

If you require further assistance please contact the Asset Protection team via e-mail ([assetprotection@nationalgrid.com](mailto:assetprotection@nationalgrid.com)) or via the contact details at the top of this response.

## Are My Works Affected?

Is your proposal an Initial Enquiry or Planned Works Application?

### Emergency Enquiry

The operations technicians in your area have received your enquiry and will be aware of its emergency status. They will endeavour to contact you as soon as they can to arrange a visit. If the work must be completed immediately, please call us on 01926 654844 and we will make sure the local engineers are aware of the urgency.

If the emergency nature of this enquiry is related to a safety issue with a National Grid Gas Transmission Plc pipeline, please call the National Gas Emergency number on 0800 111 999.

### Initial Enquiry

As your works are at an "initial" stage, any maps and guidance provided are for information purposes only. This is not approval to commence work. You must submit a "Planned Works" enquiry at the earliest opportunity and failure to do this may lead to disruption to your plans and works. Asset Protection will endeavour to provide an initial assessment within 28 days of receipt of a Planned Works enquiry and, dependent on the outcome of this, further consultation may be required. In any event, for safety and legal reasons, works must not be carried out until a Planned Works enquiry has been completed and final response received.

### Planned Works

Your proposal is in proximity of National Grid Gas Transmission plc's apparatus, as shown on the attached map, which may impact, and possibly prevent, your proposed activities for safety and/or legal reasons. You must not commence any work until you have sent details to us at [assetprotection@nationalgrid.com](mailto:assetprotection@nationalgrid.com) and have received a response back confirming that we have no objections to the work taking place. You must read and follow all the guidance provided when planning or undertaking any activities at this location. We will contact you within 28 working days of you providing us with the details of your work at the email address above. Please email, or call us at 01926 654844, if you have not had a response within this time frame.

## Assessment

### Affected Apparatus

The apparatus that has been identified as being in the vicinity of your proposed works is:

- National Gas Transmission Pipelines and associated equipment

## Requirements

### National High Pressure Gas Pipelines

BEFORE carrying out any work you must:

- Ensure that no works are undertaken in the vicinity of our gas pipelines and that no heavy plant, machinery or vehicles cross the route of the pipeline until detailed consultation has taken place.
- Carefully read these requirements including the attached guidance documents and maps showing the location of apparatus.
- Contact the landowner and ensure any proposed works in private land do not infringe National Grid's legal rights (i.e. easements or wayleaves). If the works are in the road or footpath the relevant local authority should be contacted.
- Ensure that all persons, including direct labour and contractors, working for you on or near National Grid's apparatus follow the requirements of the HSE Guidance Notes HSG47 - 'Avoiding Danger from Underground Services' This guidance can be downloaded free of charge at <http://www.hse.gov.uk>
- In line with the above guidance, verify and establish the actual position of mains, pipes, cables, services and other apparatus on site before any activities are undertaken.

DURING any work you must:

- Ensure that the National Grid requirements are followed for work in the vicinity of High pressure pipelines including the supervision of the digging of trial holes.
- Comply with all guidance relating to general activities and any specific guidance for each asset type as specified in the Guidance Section below.
- Ensure that access to National Grid apparatus is maintained at all times.
- Prevent the placing of heavy construction plant, equipment, materials or the passage of heavy vehicles over National Grid apparatus unless specifically agreed with National Grid in advance.
- Exercise extreme caution if slab (mass) concrete is encountered during excavation works as this may be protecting or supporting National Grid apparatus.
- Maintain appropriate clearances between gas apparatus and the position of other buried plant.

## GUIDANCE

### National Grid Gas Transmission Network data

The Network map for National Grid Gas Transmission assets can be downloaded at the following link in GIS format.

<https://www.nationalgrid.com/uk/gas-transmission/land-and-assets/network-route-maps>

### High Pressure Gas Pipelines Guidance:

If working in the vicinity of a high pressure gas pipeline the following document must be followed: 'Specification for Safe Working in the Vicinity of National Grid High Pressure Gas Pipelines and Associated Installation – Requirements for Third Parties' (SSW22). This can be obtained from:

<Link to SSW22 once it has been updated and signed off>

### Essential Guidance document:

<https://www.nationalgrid.com/uk/gas-transmission/sites/gas/files/documents/8589934982-Essential%20Guidance.pdf>

You should be aware of the following information regarding National Grid's high pressure (1) underground pipelines and associated apparatus:

- Our underground pipelines are protected by permanent agreements with landowners or have been laid in the public highway under our licence. These grant us legal rights that enable us to achieve efficient and reliable operation, maintenance, repair and refurbishment of our gas transmission network. Hence we require that no permanent structures are built over or under pipelines or within the zone specified in the agreement, materials or soil are not stacked or stored on top of the pipeline route and that unrestricted and safe access to any of our pipeline(s) must be maintained at all times.
- The information supplied is given in good faith and only as a guide to the location of our underground pipelines. The accuracy of this information cannot be guaranteed. The physical presence of such pipelines may also be evident from pipeline marker posts. The person(s) responsible for planning, supervising and carrying out work in proximity to our pipeline(s) shall be liable to us, as pipeline(s) owner, as well as to any third party who may be affected in any way by any loss or damage resulting from their failure to locate and avoid any damage to such a pipeline(s).
- The relevant guidance in relation to working safely near to existing underground pipelines is contained within the Health and Safety Executive's ([www.hse.gov.uk](http://www.hse.gov.uk)) Guidance HS(G)47 "Avoiding Danger From Underground Services" and all relevant site staff should make sure that they are both aware of and understand this guidance.
- Our pipelines are normally buried to a depth of 1.2 metres or more below ground and further information may be found on the plans provided. Ground cover above our pipelines should not be reduced or increased.
- Any proposed cable crossings are subject to approval from National Grid, completion of a Deed of Consent and must remain a minimum of 600mm above or below the pipeline. All works associated with cable installation must be supervised by National Grid. Cables cannot be pulled through until a Deed of Consent is in place.
- If it is planned to use mechanical excavators and any other powered mechanical plant, it shall not be sited or moved above the pipeline.
- If it is planned to carry out excavation to a depth greater than 0.3 metres, embankment or dredging works, the actual position and depth of the pipeline must be established on site with our representative and a safe working method agreed prior to any work taking place in order to minimise the risk of damage and ensure the final depth of cover does not affect the integrity of the pipeline.

- The digging of trial holes to locate the pipeline must be carried out under the supervision of our on-site representative following approval of RAMS. Excavation works may take place unsupervised no closer than 3 metres from the pipeline once its actual location has been confirmed. Similarly, excavation with handheld power tools may take place no closer than 1.5 metres away.
- For operational and safety reasons National Grid requires unrestricted access to our Above Ground Installations and Compressor Stations. We would request that any proposed changes to roads/layouts in the vicinity of our site have regard to the need to maintain access.
- Any construction traffic should either cross the pipeline using existing roads or at agreed crossing locations using agreed protective measures.
- Ground anchors for scaffolding stay wires should only be sited in the vicinity of the pipeline after the pipeline position has been confirmed on site with our representative and the ground anchor position agreed.
- If your proposals include the installation of wind turbines then the minimum separation between the pipeline and the nearest turbine should be 1.5 times the mast height.
- If your proposals include the installation of a Solar Farm, all assets must remain outside of the National Grid easement, all cable crossings must be agreed during the design stage, a Deed of Consent undertaken and an Earthing report must be provided for review. National Grid must retain access to its assets at all times once works have been completed.

The relocation of existing underground pipelines is not normally feasible on grounds of cost, operation and maintenance and environmental impact. Further details can be found in our specification for: safe working in the vicinity of National Grid high pressure gas pipelines and associated installations – requirements for third parties: T/SP/SSW/22 (see link above or copy enclosed)

# Overview map of worksite

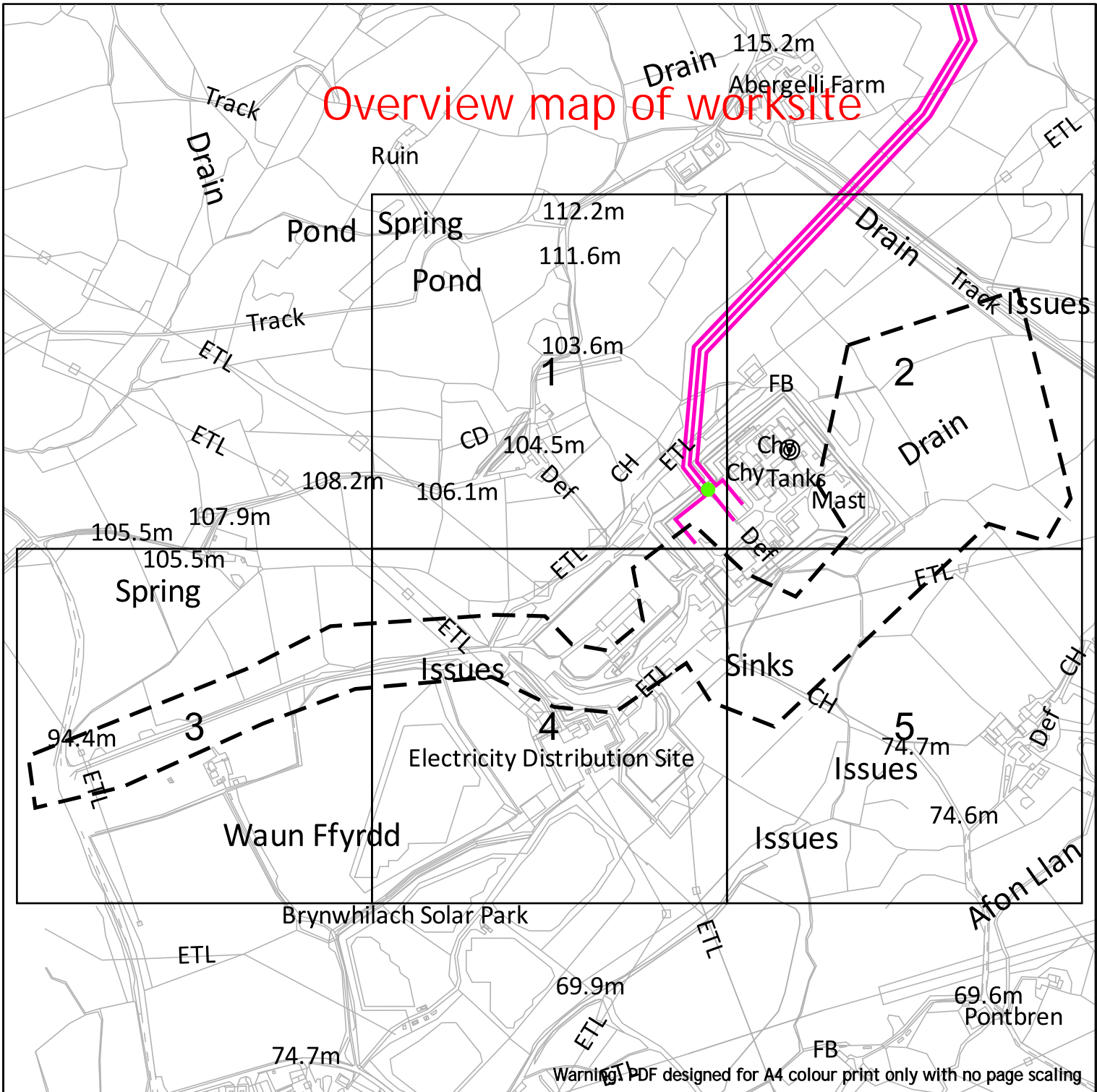

**nationalgrid**

**National Grid House**  
Warwick Technology Park  
Gallows Hill  
Warwick  
CV34 6DA

AssetProtection@NationalGrid.com

Dig Sites    Area:    Line:

NHP Mains

Date Requested: 05/12/2022  
Job Reference: 27820377  
Site Location: 265236 200946  
Requested by: Mr Ben Evans

Your Scheme/Reference: LM  
115410/DK

**IMPORTANT NOTICES**

This plan shows those pipes owned by National Grid Limited in its role as a licensed Gas Transporter (GT). Gas pipes owned by other GTs, or otherwise privately owned, may be present in this area. Information with regards to such pipes should be obtained from the relevant owners. The information shown on this plan is given without warranty, the accuracy thereof cannot be guaranteed. Service pipes, valves, syphons, stub connections, etc., are not shown but their presence should be anticipated. No liability of any kind whatsoever is accepted by National Grid Limited or their agents, servants or contractors for any error or omission. Safe digging practices, in accordance with HS(G)47, must be used to verify and establish the actual position of mains, pipes, services and other apparatus on site before any mechanical plant is used. It is your responsibility to ensure that this information is provided to all persons (either direct labour or contractors) working for you on or near gas apparatus. The information included on this plan should not be referred to beyond a period of 28 days from the date of issue.

**National Grid Gas Emergency Number: 0800 111 999**

Available 24 hours, 7 days/week. Calls may be recorded and monitored

Scale: 1:7688 (When plotted at A4)

Crown Copyright © - Reproduced by permission of Ordnance Survey on behalf of HMSO. And database right 2022. All rights reserved. Ordnance Survey Licence number 0100059731

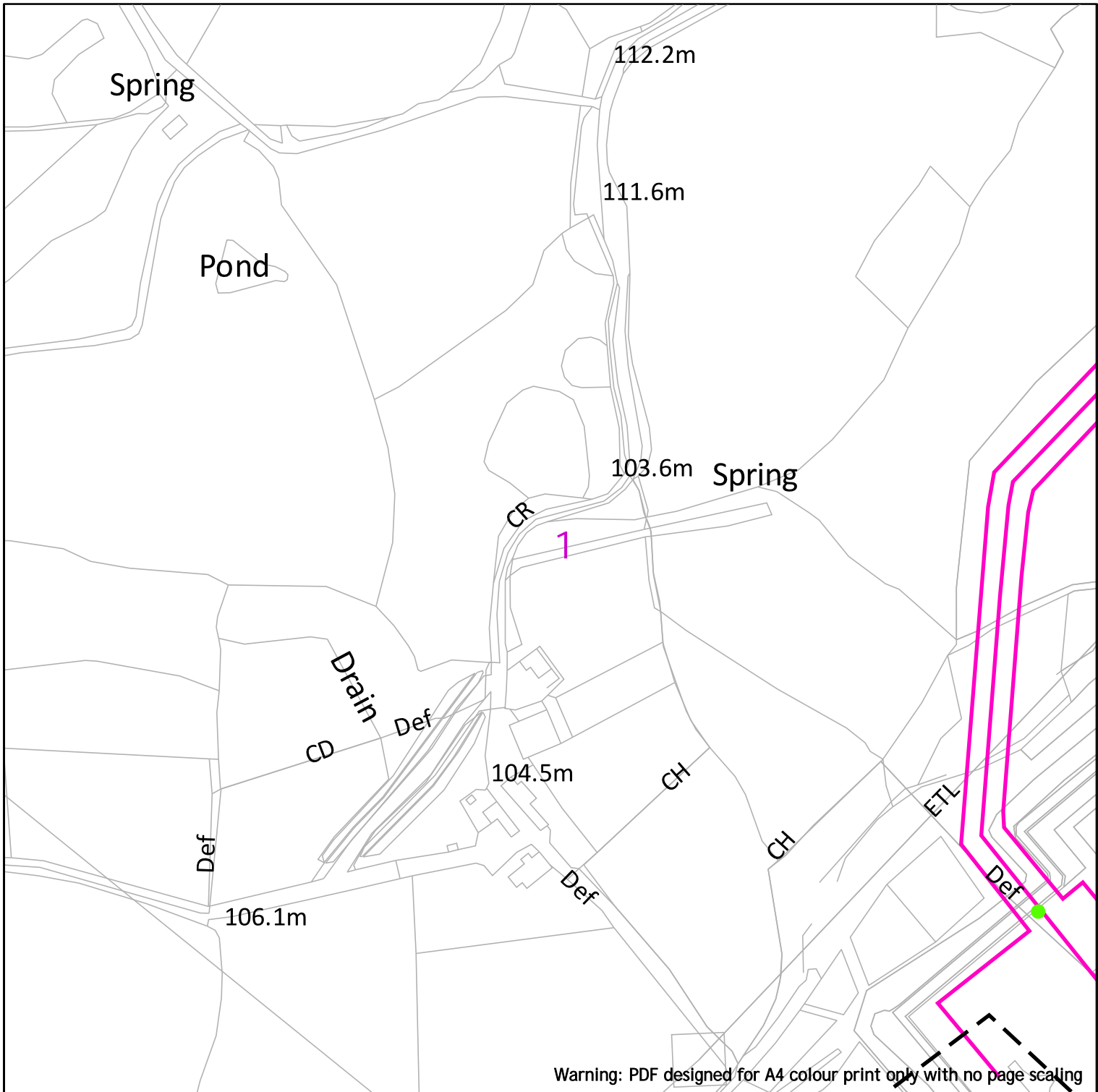

Warning: PDF designed for A4 colour print only with no page scaling



Dig Sites Area: [dashed box] Line: [dashed line]

[pink line] NHP Mains

**National Grid House**  
 Warwick Technology Park  
 Gallows Hill  
 Warwick  
 CV34 6DA

AssetProtection@NationalGrid.com

Date Requested: 05/12/2022  
 Job Reference: 27820377  
 Site Location: 265236 200946  
 Requested by: Mr Ben Evans

Your Scheme/Reference: LM  
 115410/DK

**IMPORTANT NOTICES**

This plan shows those pipes owned by National Grid Limited in its role as a licensed Gas Transporter (GT). Gas pipes owned by other GTs, or otherwise privately owned, may be present in this area. Information with regards to such pipes should be obtained from the relevant owners. The information shown on this plan is given without warranty, the accuracy thereof cannot be guaranteed. Service pipes, valves, syphons, stub connections, etc., are not shown but their presence should be anticipated. No liability of any kind whatsoever is accepted by National Grid Limited or their agents, servants or contractors for any error or omission. Safe digging practices, in accordance with HS(G)47, must be used to verify and establish the actual position of mains, pipes, services and other apparatus on site before any mechanical plant is used. It is your responsibility to ensure that this information is provided to all persons (either direct labour or contractors) working for you on or near gas apparatus. The information included on this plan should not be referred to beyond a period of 28 days from the date of issue.

**National Grid Gas Emergency Number: 0800 111 999**

Available 24 hours, 7 days/week. Calls may be recorded and monitored

Scale: 1:2500 (When plotted at A4)



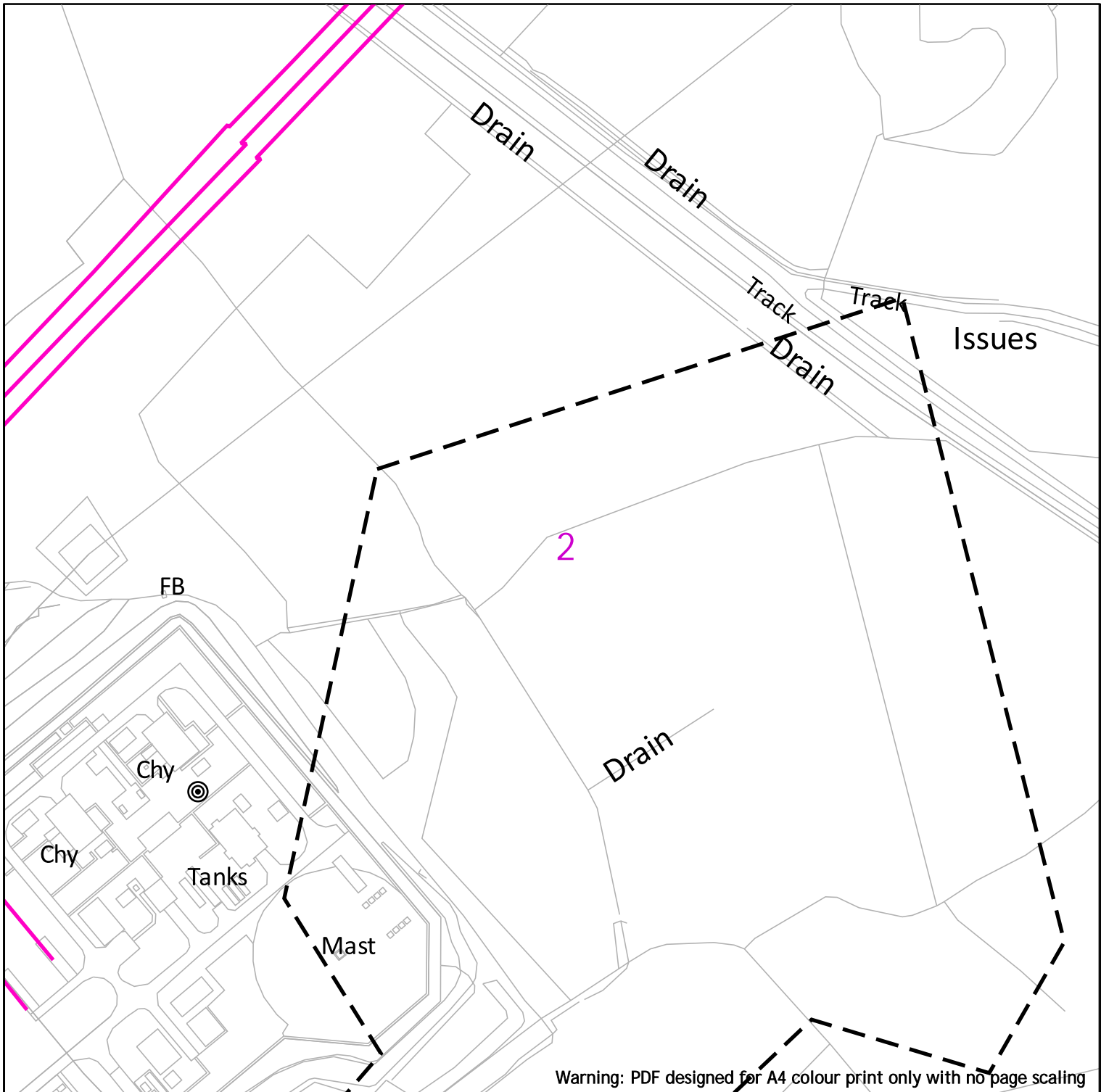

Warning: PDF designed for A4 colour print only with no page scaling

**nationalgrid**



Dig Sites Area: [dashed box] Line: [dashed line]

[pink line] NHP Mains

**National Grid House**

Warwick Technology Park  
Gallows Hill  
Warwick  
CV34 6DA

AssetProtection@NationalGrid.com

Date Requested: 05/12/2022

Job Reference: 27820377

Site Location: 265236 200946

Requested by: Mr Ben Evans

Your Scheme/Reference: LM  
115410/DK

**IMPORTANT NOTICES**

This plan shows those pipes owned by National Grid Limited in its role as a licensed Gas Transporter (GT). Gas pipes owned by other GTs, or otherwise privately owned, may be present in this area. Information with regards to such pipes should be obtained from the relevant owners. The information shown on this plan is given without warranty, the accuracy thereof cannot be guaranteed. Service pipes, valves, syphons, stub connections, etc., are not shown but their presence should be anticipated. No liability of any kind whatsoever is accepted by National Grid Limited or their agents, servants or contractors for any error or omission. Safe digging practices, in accordance with HS(G)47, must be used to verify and establish the actual position of mains, pipes, services and other apparatus on site before any mechanical plant is used. It is your responsibility to ensure that this information is provided to all persons (either direct labour or contractors) working for you on or near gas apparatus. The information included on this plan should not be referred to beyond a period of 28 days from the date of issue.

**National Grid Gas Emergency Number: 0800 111 999**

Available 24 hours, 7 days/week. Calls may be recorded and monitored

Scale: 1:2500 (When plotted at A4)

Crown Copyright © - Reproduced by permission of Ordnance Survey on behalf of HMSO. And database right 2022. All rights reserved. Ordnance Survey Licence number 0100059731

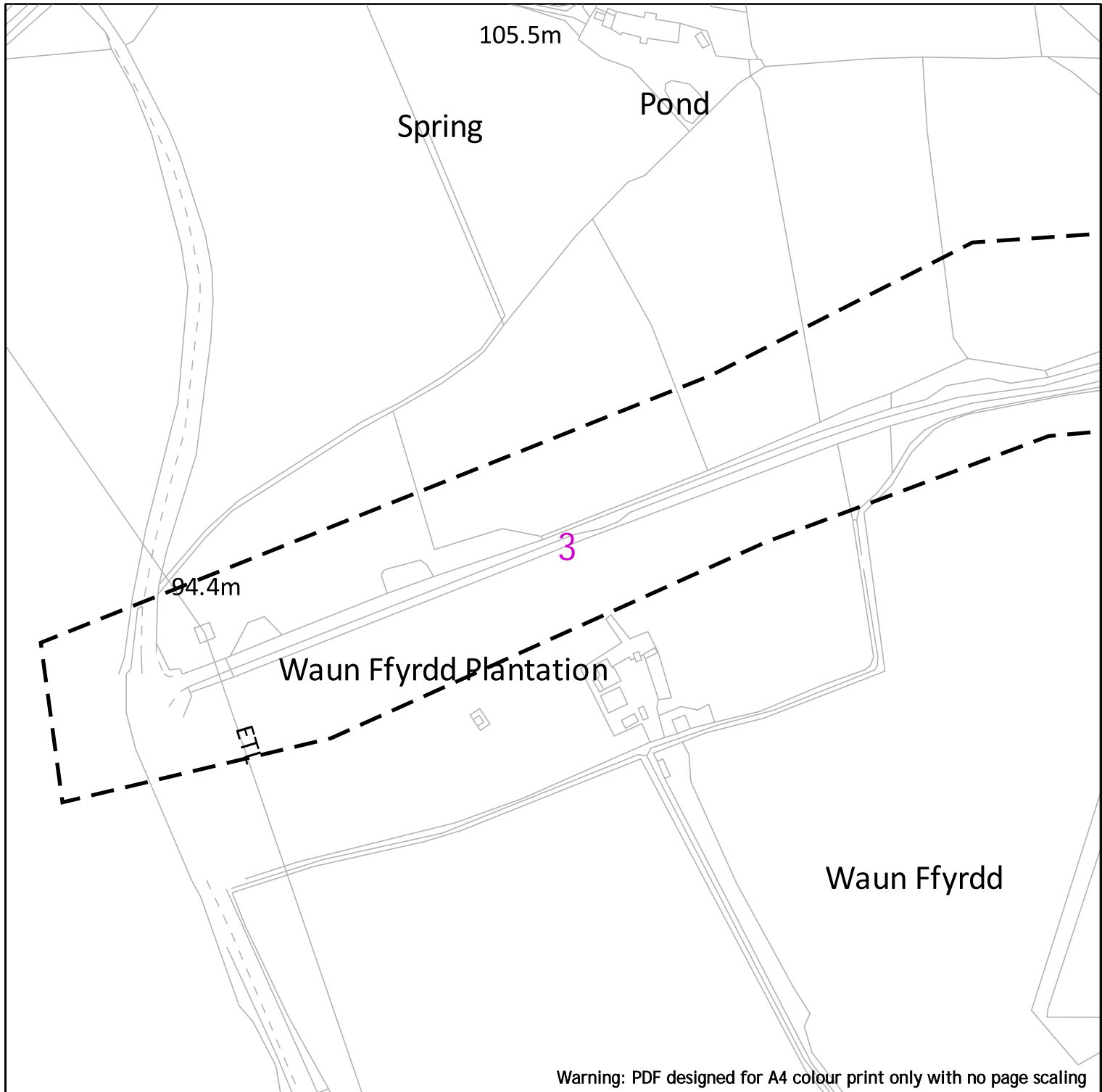

**nationalgrid**

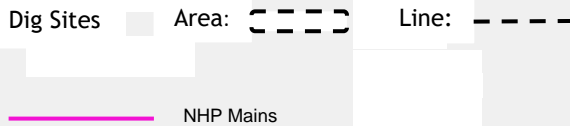

**National Grid House**  
 Warwick Technology Park  
 Gallows Hill  
 Warwick  
 CV34 6DA

AssetProtection@NationalGrid.com

Date Requested: 05/12/2022  
 Job Reference: 27820377  
 Site Location: 265236 200946  
 Requested by: Mr Ben Evans

Your Scheme/Reference: LM  
 115410/DK

**IMPORTANT NOTICES**

This plan shows those pipes owned by National Grid Limited in its role as a licensed Gas Transporter (GT). Gas pipes owned by other GTs, or otherwise privately owned, may be present in this area. Information with regards to such pipes should be obtained from the relevant owners. The information shown on this plan is given without warranty, the accuracy thereof cannot be guaranteed. Service pipes, valves, syphons, stub connections, etc., are not shown but their presence should be anticipated. No liability of any kind whatsoever is accepted by National Grid Limited or their agents, servants or contractors for any error or omission. Safe digging practices, in accordance with HS(G)47, must be used to verify and establish the actual position of mains, pipes, services and other apparatus on site before any mechanical plant is used. It is your responsibility to ensure that this information is provided to all persons (either direct labour or contractors) working for you on or near gas apparatus. The information included on this plan should not be referred to beyond a period of 28 days from the date of issue.

**National Grid Gas Emergency Number: 0800 111 999**

Available 24 hours, 7 days/week. Calls may be recorded and monitored

Scale: 1:2500 (When plotted at A4)

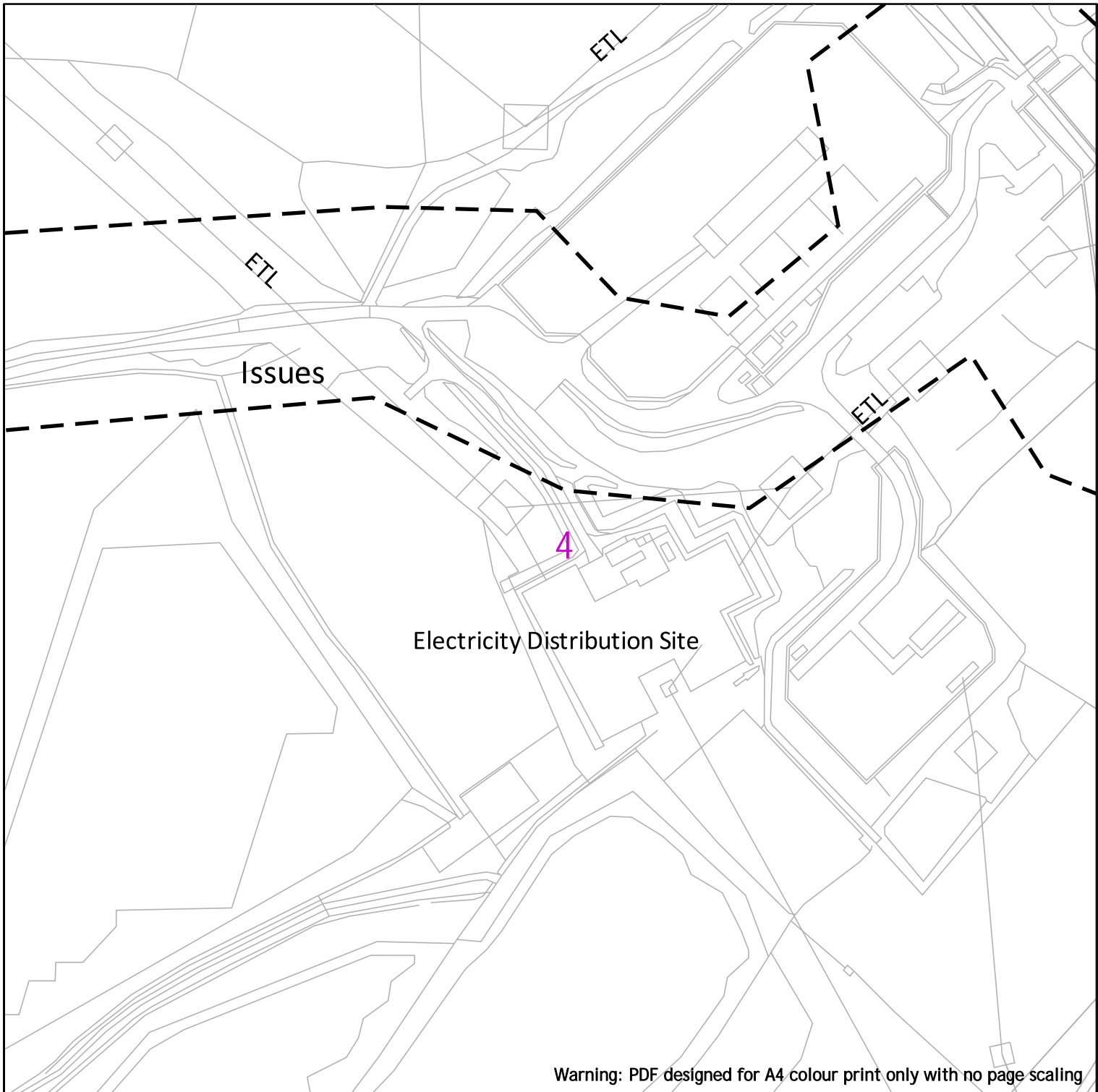

Warning: PDF designed for A4 colour print only with no page scaling

**nationalgrid**



Dig Sites    Area:     Line: 

 NHP Mains

**National Grid House**  
 Warwick Technology Park  
 Gallows Hill  
 Warwick  
 CV34 6DA

AssetProtection@NationalGrid.com

Date Requested: 05/12/2022  
 Job Reference: 27820377  
 Site Location: 265236 200946  
 Requested by: Mr Ben Evans

Your Scheme/Reference: LM  
 115410/DK

**IMPORTANT NOTICES**

This plan shows those pipes owned by National Grid Limited in its role as a licensed Gas Transporter (GT). Gas pipes owned by other GTs, or otherwise privately owned, may be present in this area. Information with regards to such pipes should be obtained from the relevant owners. The information shown on this plan is given without warranty, the accuracy thereof cannot be guaranteed. Service pipes, valves, syphons, stub connections, etc., are not shown but their presence should be anticipated. No liability of any kind whatsoever is accepted by National Grid Limited or their agents, servants or contractors for any error or omission. Safe digging practices, in accordance with HS(G)47, must be used to verify and establish the actual position of mains, pipes, services and other apparatus on site before any mechanical plant is used. It is your responsibility to ensure that this information is provided to all persons (either direct labour or contractors) working for you on or near gas apparatus. The information included on this plan should not be referred to beyond a period of 28 days from the date of issue.

**National Grid Gas Emergency Number: 0800 111 999**

Available 24 hours, 7 days/week. Calls may be recorded and monitored

Scale: 1:2500 (When plotted at A4)

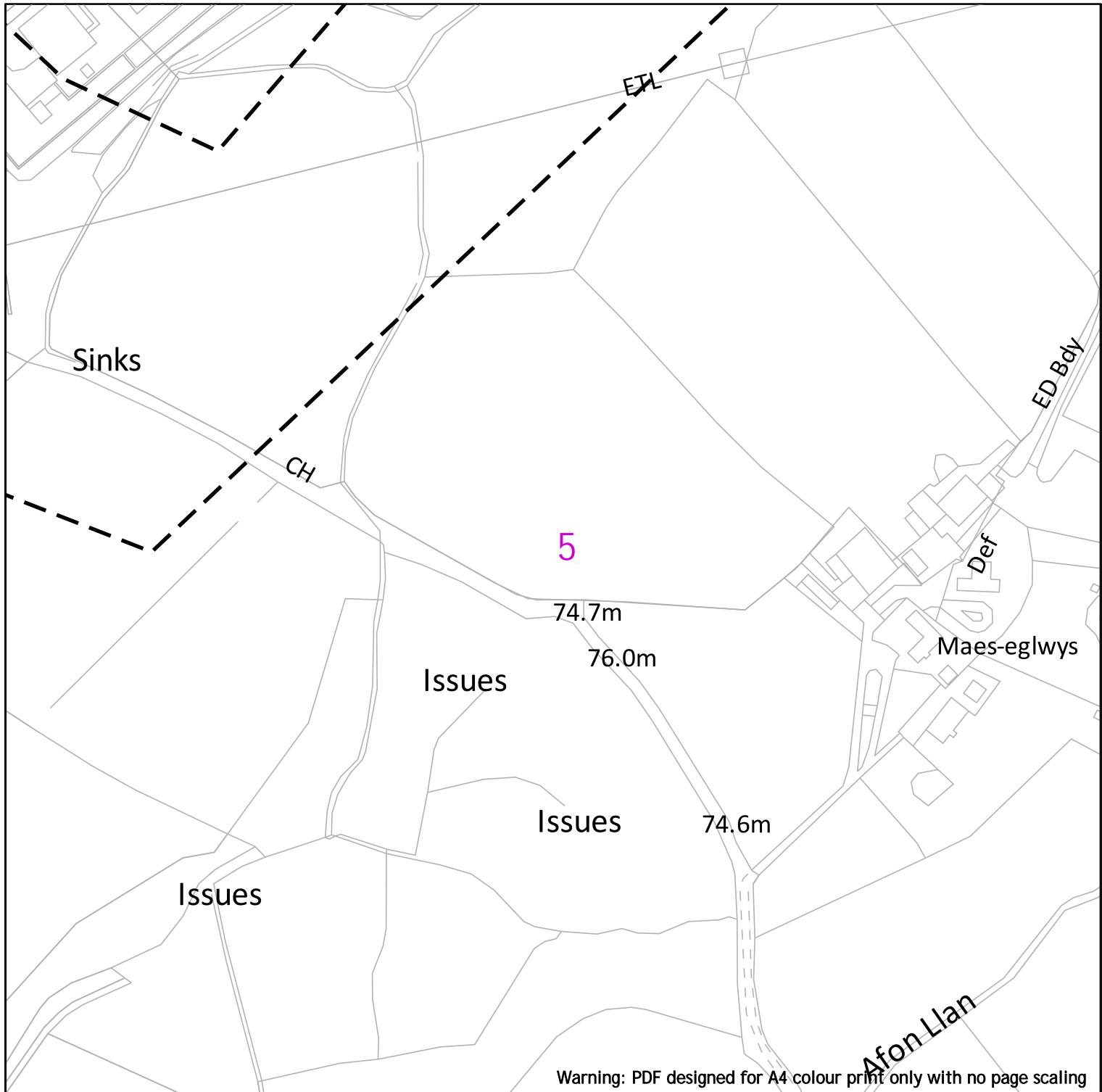

**nationalgrid**

**National Grid House**  
 Warwick Technology Park  
 Gallows Hill  
 Warwick  
 CV34 6DA

AssetProtection@NationalGrid.com

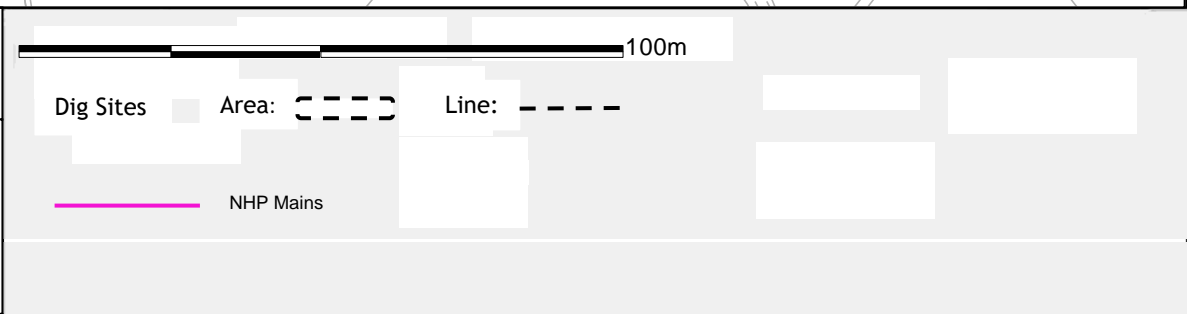

Date Requested: 05/12/2022  
 Job Reference: 27820377  
 Site Location: 265236 200946  
 Requested by: Mr Ben Evans

Your Scheme/Reference: LM  
 115410/DK

Scale: 1:2500 (When plotted at A4)

**IMPORTANT NOTICES**  
 This plan shows those pipes owned by National Grid Limited in its role as a licensed Gas Transporter (GT). Gas pipes owned by other GTs, or otherwise privately owned, may be present in this area. Information with regards to such pipes should be obtained from the relevant owners. The information shown on this plan is given without warranty, the accuracy thereof cannot be guaranteed. Service pipes, valves, syphons, stub connections, etc., are not shown but their presence should be anticipated. No liability of any kind whatsoever is accepted by National Grid Limited or their agents, servants or contractors for any error or omission. Safe digging practices, in accordance with HS(G)47, must be used to verify and establish the actual position of mains, pipes, services and other apparatus on site before any mechanical plant is used. It is your responsibility to ensure that this information is provided to all persons (either direct labour or contractors) working for you on or near gas apparatus. The information included on this plan should not be referred to beyond a period of 28 days from the date of issue.

**National Grid Gas Emergency Number: 0800 111 999**  
 Available 24 hours, 7 days/week. Calls may be recorded and monitored

Crown Copyright © - Reproduced by permission of Ordnance Survey on behalf of HMSO. And database right 2022. All rights reserved. Ordnance Survey Licence number 0100059731

# ENQUIRY SUMMARY

## Received Date

05/12/2022 8:17

## Work Start Date

06/12/2022

## Your Reference

LM 115410/DK

## Location

Centre Point: 265236 200946

X Extent:

Y Extent:

Postcode: SA5 7LU

## Map Options

Paper Size: A4

Orientation: PORTRAIT

Scale: 1:2500

Real World Extents: 1466m x 728m

## Enquirer Details

Organisation Name: Atkins - Utility Solutions

Contact Name: Ben Evans

Email Address: searches.utilitysolutions@atkinglobal.com

Telephone: 01454662086

Address: The Hub, 500 Park Avenue, Aztec West, Almondsbury, Bristol, BS32 4RZ

## Enquiry Type

Initial Enquiry

## Activity Type

Utility Works

## Work Types

Single excavations site (deeper than 1.5m)

## Notes/Works Description (if supplied)

## Site Contact Name (if supplied)

## Site Contact Number (if supplied)

**From:** Dain Fuller <Dain.Fuller@networkrail.co.uk> on behalf of OP Buried Services Enquiries <OPBuriedServicesEnquiries@networkrail.co.uk>  
**Sent:** 05 December 2022 14:48  
**To:** Utility Solutions GDC Requests  
**Subject:** RE: Plant Enquiry - 115410 - Site near Rhydypanyd Road, Felindre, Swansea - Please respond by 06/12/2022

OFFICIAL

Dear Enquirer,

With regards to your enquiry, Network Rail does not believe there is any Network Rail owned apparatus or underground services within the area you have defined. As there is always the possibility that new works could be planned and undertaken in this area by Network Rail this information is valid as at today's date and is supplied for general guidance only.

Please be aware that this response is based on Network Rail's records and knowledge and no guarantee can be given regarding accuracy or completeness. CAT scans, safe digging practices (as contained in HSE publications) and other appropriate investigative techniques should always be carried out.

There may be other apparatus or underground services owned or operated by Utility Companies and accordingly you should contact individual utilities for information.

If, in connection with your investigations and/or work, you become aware of Network Rail apparatus or underground services within your area of work, please ensure these are notified to our Asset Protection team via the following link as a matter of urgency so that appropriate measures for avoidance of risk and damage can be put in place.

Contact details can be found in the following link: [Network Rail Asset Protection Teams](#)

If you require any further clarification on any of the information provided by the team, please contact [opburiedservicesenquiries@networkrail.co.uk](mailto:opburiedservicesenquiries@networkrail.co.uk).

Regards,

**Dain Fuller**

Worksite Survey Manager



**Worksite Survey | Asset Information Services**

National Records Centre | Audax Road | York YO30 4US

W: [www.networkrail.co.uk](http://www.networkrail.co.uk)

## Bhaaskar, Aadhithyaa

---

**From:** NRSWA <nrswa.nrswa@sky.uk>  
**Sent:** 06 December 2022 20:26  
**To:** Utility Solutions GDC Requests  
**Subject:** Plant Enquiry - 115410 - Site near Rhydypany Road, Felindre, Swansea - 06/12/2022



Thank you for your enquiry.

Please be advised that Sky Telecommunications Services Ltd will not be affected by your proposal.

Best endeavours have been made to ensure accuracy, however if you require further information, please contact us by email at [nrswa@sky.uk](mailto:nrswa@sky.uk).

Regards



NRSWA Department  
Sky UK - Technology - Operations

 [nrswa@sky.uk](mailto:nrswa@sky.uk)  +44 2070323234

---

**From:** requests.utilitysolutions@atkinglobal.com <requests.utilitysolutions@atkinglobal.com>  
**Sent:** 05 December 2022 05:27  
**Cc:** requests.utilitysolutions@atkinglobal.com  
**Subject:** [EXTERNAL] Plant Enquiry - 115410 - Site near Rhydypany Road, Felindre, Swansea - Please respond by 06/12/2022

Our Reference: 115410  
Site Name: Site near Rhydypany Road, Felindre, Swansea  
Works Description: Building works (low rise) including tree planting and Installation of fencing, barriers, bollards, signage. Other (please state in Additional Works Description)  
Site Grid References: 265249 200946,265428 201045,264081 200648,265375 201253,264083 200639

To whom it may concern,

Please find enclosed a plant enquiry for your attention.

**From:** UK OSP-Team . <osp-team@verizon.com>  
**Sent:** 05 December 2022 12:34  
**To:** Utility Solutions GDC Requests; UK OSP-Team  
**Subject:** Re: Plant Enquiry - 115410 - Site near Rhydypany Road, Felindre, Swansea - Please respond by 06/12/2022

Dear Sir/Madam

Verizon is a licensed Statutory Undertaker.

We have reviewed your plans and have determined that Verizon (Formally known as MCI WorldCom, MFS) has no apparatus in the areas concerned.

If you have any further queries please do not hesitate to get in touch.

Yours faithfully

Plant Protection Officer (GB) Email [osp-team@uk.verizon.com](mailto:osp-team@uk.verizon.com)

On Mon, 5 Dec 2022 at 05:29, <[requests.utilityolutions@atkinglobal.com](mailto:requests.utilityolutions@atkinglobal.com)> wrote:

Our Reference: 115410

Site Name: Site near Rhydypany Road, Felindre, Swansea

Works Description: Building works (low rise) including tree planting and Installation of fencing, barriers, bollards, signage. Other (please state in Additional Works Description)

Site Grid References: 265249 200946,265428 201045,264081 200648,265375 201253,264083 200639

To whom it may concern,

Please find enclosed a plant enquiry for your attention.

**We request plans showing the location of your company's affected plant in relation to the [entire site area shown within the boundary on the attached map](#). Grid references and**





As of 05/12/2022, Virgin Media are deemed to be not affected by your site.

An additional response from Virgin Media in relation to your area of interest is available on request from Landmark Customer Services with prices starting from £43 + VAT.

No liability of any kind whatsoever is accepted by Landmark Information Group, its servants or agents, for any error or omission in respect of information contained in this report. The underground services must be verified and established on site before any excavation is carried out.

## **APPENDIX 2**

### **Greenfield Runoff Rates**

Print

Close Report



# Greenfield runoff rate estimation for sites

www.ukuds.com | Greenfield runoff tool

Calculated by:

Site name:

Site location:

### Site Details

Latitude:

Longitude:

Reference:

Date:

This is an estimation of the greenfield runoff rates that are used to meet normal best practice criteria in line with Environment Agency guidance "Rainfall runoff management for developments", SC030219 (2013), the SuDS Manual C753 (Ciria, 2015) and the non-statutory standards for SuDS (Defra, 2015). This information on greenfield runoff rates may be the basis for setting consents for the drainage of surface water runoff from sites.

Runoff estimation approach

### Site characteristics

Total site area (ha):

### Methodology

Q<sub>BAR</sub> estimation method:

SPR estimation method:

Soil characteristics	Default	Edited
SOIL type:	<input type="text" value="3"/>	<input type="text" value="3"/>
HOST class:	<input type="text" value="N/A"/>	<input type="text" value="N/A"/>
SPR/SPRHOST:	<input type="text" value="0.37"/>	<input type="text" value="0.37"/>

### Hydrological characteristics

	Default	Edited
SAAR (mm):	<input type="text" value="1439"/>	<input type="text" value="1439"/>
Hydrological region:	<input type="text" value="9"/>	<input type="text" value="9"/>
Growth curve factor 1 year:	<input type="text" value="0.88"/>	<input type="text" value="0.88"/>
Growth curve factor 30 years:	<input type="text" value="1.78"/>	<input type="text" value="1.78"/>
Growth curve factor 100 years:	<input type="text" value="2.18"/>	<input type="text" value="2.18"/>
Growth curve factor 200 years:	<input type="text" value="2.46"/>	<input type="text" value="2.46"/>

### Notes

#### (1) Is Q<sub>BAR</sub> < 2.0 l/s/ha?

When Q<sub>BAR</sub> is < 2.0 l/s/ha then limiting discharge rates are set at 2.0 l/s/ha.

#### (2) Are flow rates < 5.0 l/s?

Where flow rates are less than 5.0 l/s consent for discharge is usually set at 5.0 l/s if blockage from vegetation and other materials is possible. Lower consent flow rates may be set where the blockage risk is addressed by using appropriate drainage elements.

#### (3) Is SPR/SPRHOST ≤ 0.3?

Where groundwater levels are low enough the use of soakaways to avoid discharge offsite would normally be preferred for disposal of surface water runoff.

Greenfield runoff rates	Default	Edited
Q <sub>BAR</sub> (l/s):	<input type="text" value="6.68"/>	<input type="text" value="6.68"/>
1 in 1 year (l/s):	<input type="text" value="5.87"/>	<input type="text" value="5.87"/>
1 in 30 years (l/s):	<input type="text" value="11.88"/>	<input type="text" value="11.88"/>
1 in 100 year (l/s):	<input type="text" value="14.55"/>	<input type="text" value="14.55"/>
1 in 200 years (l/s):	<input type="text" value="16.42"/>	<input type="text" value="16.42"/>

This report was produced using the greenfield runoff tool developed by HR Wallingford and available at [www.uksuds.com](http://www.uksuds.com). The use of this tool is subject to the UK SuDS terms and conditions and licence agreement, which can both be found at [www.uksuds.com/terms-and-conditions.htm](http://www.uksuds.com/terms-and-conditions.htm). The outputs from this tool are estimates of greenfield runoff rates. The use of these results is the responsibility of the users of this tool. No liability will be accepted by HR Wallingford, the Environment Agency, CEH, Hydrosolutions or any other organisation for the use of this data in the design or operational characteristics of any drainage scheme.

**APPENDIX 3**  
**Attenuation Estimates**

# Calculation Sheet



REF:

CLIENT: Stratkraft LTD	PROJECT: Stratkraft 'Greener Grid Park'	JOB NO.: ST19905	CALC. REF. NO.:
			PAGE: 1 OF 1
CALCULATION	CALC. BY:	CHECKED BY:	APPROVED BY:
Attenuation Calculation	(NAME AND SIGNATURE)	(NAME AND SIGNATURE)	(NAME AND SIGNATURE)
	DATE: 16/02/2023	DATE:	DATE:

## Causeway's Flow Attenuation Estimates

Estimates based on no infiltration as a 'worst-case' scenario

Rainfall Methodology	FSR
FSR Region	England & Wales
M5-60 (mm)	20.000
Ratio-R	0.200
Summer CV	<input checked="" type="checkbox"/> 0.750
Winter CV	<input checked="" type="checkbox"/> 0.840

## Main Site

<b>Storage Estimate</b>	
Return Period (years)	30
Climate Change (%)	40
Impermeable Area (ha)	1.080
Peak Discharge (l/s)	7.220
Infiltration Coefficient (m/hr) (leave blank if no infiltration)	
Required Storage (m³)	Calc
from	776
to	1168

<b>Storage Estimate</b>	
Return Period (years)	100
Climate Change (%)	40
Impermeable Area (ha)	1.080
Peak Discharge (l/s)	7.220
Infiltration Coefficient (m/hr) (leave blank if no infiltration)	
Required Storage (m³)	Calc
from	1041
to	1448

## Access Road

<b>Storage Estimate</b>	
Return Period (years)	30
Climate Change (%)	40
Impermeable Area (ha)	0.100
Peak Discharge (l/s)	2.000
Infiltration Coefficient (m/hr) (leave blank if no infiltration)	
Required Storage (m³)	Calc
from	38
to	76

<b>Storage Estimate</b>	
Return Period (years)	100
Climate Change (%)	40
Impermeable Area (ha)	0.100
Peak Discharge (l/s)	2.000
Infiltration Coefficient (m/hr) (leave blank if no infiltration)	
Required Storage (m³)	Calc
from	56
to	102

## DRAWINGS



- KEY (L x W x H m):**
- SITE BOUNDARY
  - FENCE (3.4m HIGH)
  - HV YARD - porous gravel
  - COMMS HOUSE (7 x 13 x 3.5)
  - GENSET (3.5 x 9.6 x 3.5)
  - OFFICES (3.1 x 9.8 x 3.5)
  - STORES (2.4 x 6.1 x 2.59)
  - SYNC COMP BUILDING (25.5 x 15 x 7)
  - COOLER (2.8 x 15.8 x 2.5)
  - NOISE ATTENUATING WALL (4m HIGH)
  - ACCESS ROAD
  - POROUS GRAVEL
  - UNDERGROUND CABLE TO SUBSTATION
  - ABERGELLI DCO SHARED ACCESS
  - LANDSCAPING AND PLANTING
  - HABITAT MANAGEMENT AREA
  - ATTENUATION POND
  - — OUTFALL
  - 7m RIPARIAN BUFFER

**PROJECT:** **Statkraft**  
**Swansea Greener Grid Park**

---

**DRAWING NAME:** Site Layout **Rev I**

---

**DATE:** 05/12/2022 **SCALE:** 1:5000 at A3

Scale: 1; 5,000 Metres





# LEGEND

- Approximate Water Level
- Barrier
- Bench
- Bottom of Bank
- Block Path
- Bottom of Kerb
- Skidg
- Subsiding
- Catch Pit
- Channel
- Cable Tray Equipment
- Chimney
- Cobble Path
- Column Base
- Communication Tower
- Concrete Column
- Concrete Pole
- Conductor Lines
- Contours-Normal
- Contours-Prominent
- Conveyor Beam
- Completed Street
- Culvert
- Door
- Drain
- Eaves
- Edge of Concrete
- Edge of Grass
- Edge of Road
- Edge of Tarmac
- Edge of Track
- Edging strip
- Electric Box
- Electric Pole
- Fence Chain and Link
- Fence Post and Board
- Fence Post and Panel
- Fence Post and Wire
- Footpath
- Gate
- Gate opening
- Gully
- Hedge
- Inspection Cover
- Interior Wall
- Landing
- Lamp Post
- Marker Post
- Metal Fence
- Paving Slab
- Pipings
- Post
- Pylon
- Ridge
- Ridge and Gutter Heights
- Road Barrier
- Road Marking
- Road
- Road Column
- Sign
- Signal Light
- Skid
- Spot Level
- Step
- Steel Column
- Steelwork
- Steps
- Stonewall
- Stone Retard
- Structure
- Tank/Silo
- Top of Bank
- Temporary Fence
- Tree
- Tree Canopy
- Tree Trunk
- Vegetation
- Walkway
- Wall
- Wall
- Window

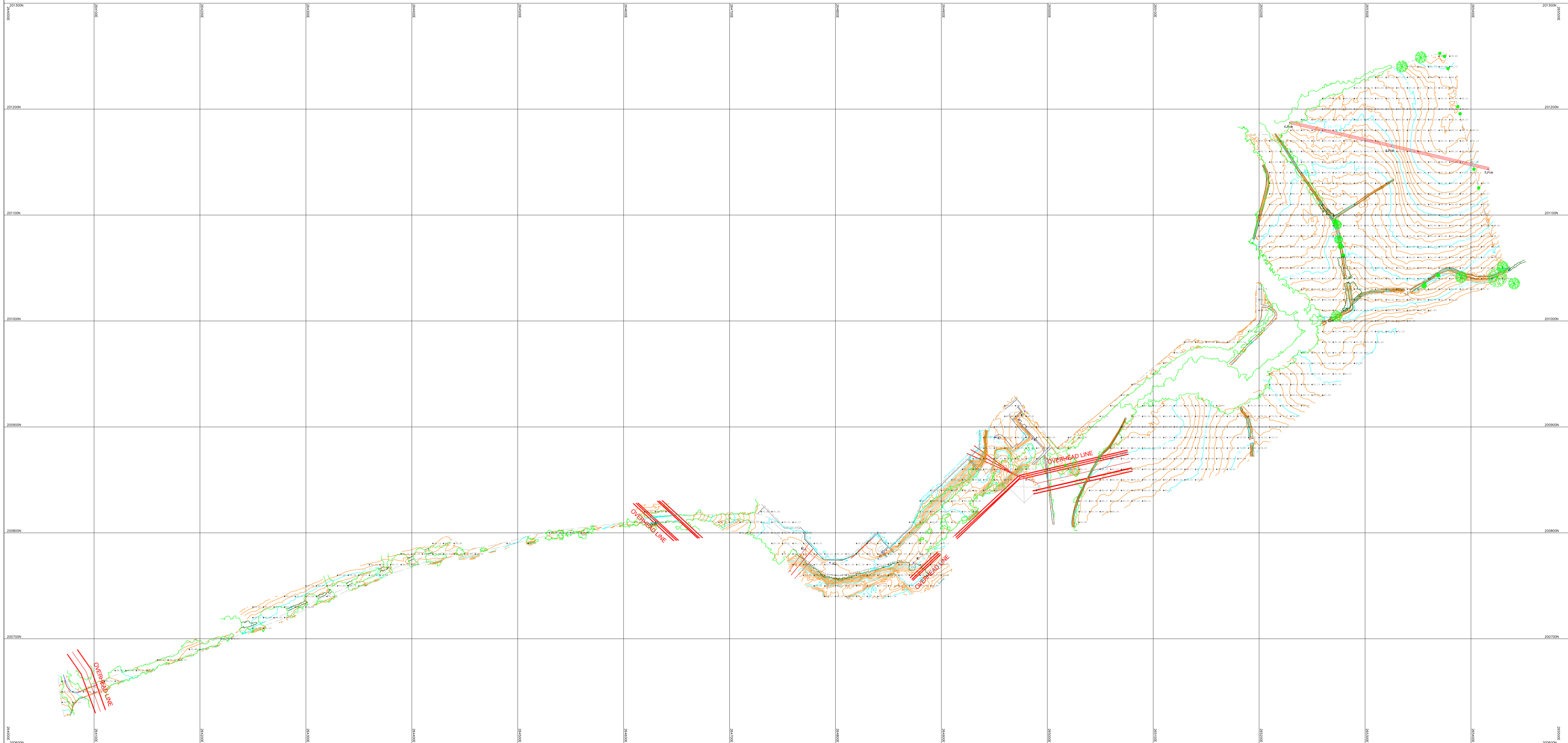

**Notes:**

Survey related to "OS Net" using real time correction with Trimble VRS Now.

Levels related to GPS Orthometric height, converted to MSL (Newlyn) by OSGM02.

Every effort has been made to identify all visible above ground features. However, bare in mind that at the time of survey, some features may have been obscured.

Treat levels in dense vegetation with caution.  
Treat levels in water with caution.

Visible features detailed on the survey may not represent the legal ownership boundaries.

Rev. Suffix	Date	Details

**SITE**

Swansea  
Felindre  
SA5 7LU

**TITLE**

Topographical Survey  
with 250mm Contour Interval  
and 10m Spot levels  
to OS Grid and Datum

DWG. No.	REV
S/DWD/HV/002	

SCALE	DATE
1:2000	16/01/2023

DRAWN	STATUS
H.Vaughan	Draft













DO NOT SCALE FROM THIS DRAWING

NOTE:

1. DRAINAGE LAYOUT IS INDICATIVE ONLY AND IS SUBJECT TO DETAILED DESIGN
2. TO BE READ IN CONJUNCTION WITH FLOOD RISK ASSESSMENT REPORT BY WARDELL ARMSTRONG DATED FEBRUARY 2023 (REF:ST19905/0011/V1.0)

KEY

-  SITE BOUNDARY
-  FILTER DRAIN
-  PROPOSED ATTENUATION POND
-  EXISTING WATERCOURSE
-  PROPOSED SURFACE WATER PIPE
-  INDICATIVE OVERLAND FLOW ROUTE
-  PROPOSED FLOW CONTROL DEVICE
-  PROPOSED PROPRIETARY DEVICE
-  PROPOSED GEOCELLULAR STORAGE TANK
-  DRY DETENTION BASIN

INDICATIVE ONLY

P0	FINAL ISSUE	19-01-23	DR	EK	AB
REVISION	DETAILS	DATE	DRN	CHK'D	APP'D

CLIENT	STATKRAFT UK LTD.				
--------	-------------------	--	--	--	--

PROJECT	STATKRAFT, SWANSEA				
---------	--------------------	--	--	--	--

DRAWING TITLE	INDICATIVE SURFACE WATER MANAGEMENT PLAN				
---------------	--	--	--	--	--

DRG No.	ST19905-002	REV	P0	SUIT. CODE	
DRG SIZE	A3	SCALE	1:1000	DATE	19-01-23
DRAWN BY	DR	CHECKED BY	EK	APPROVED BY	AB



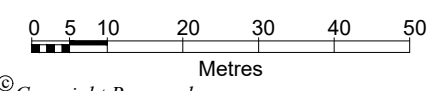
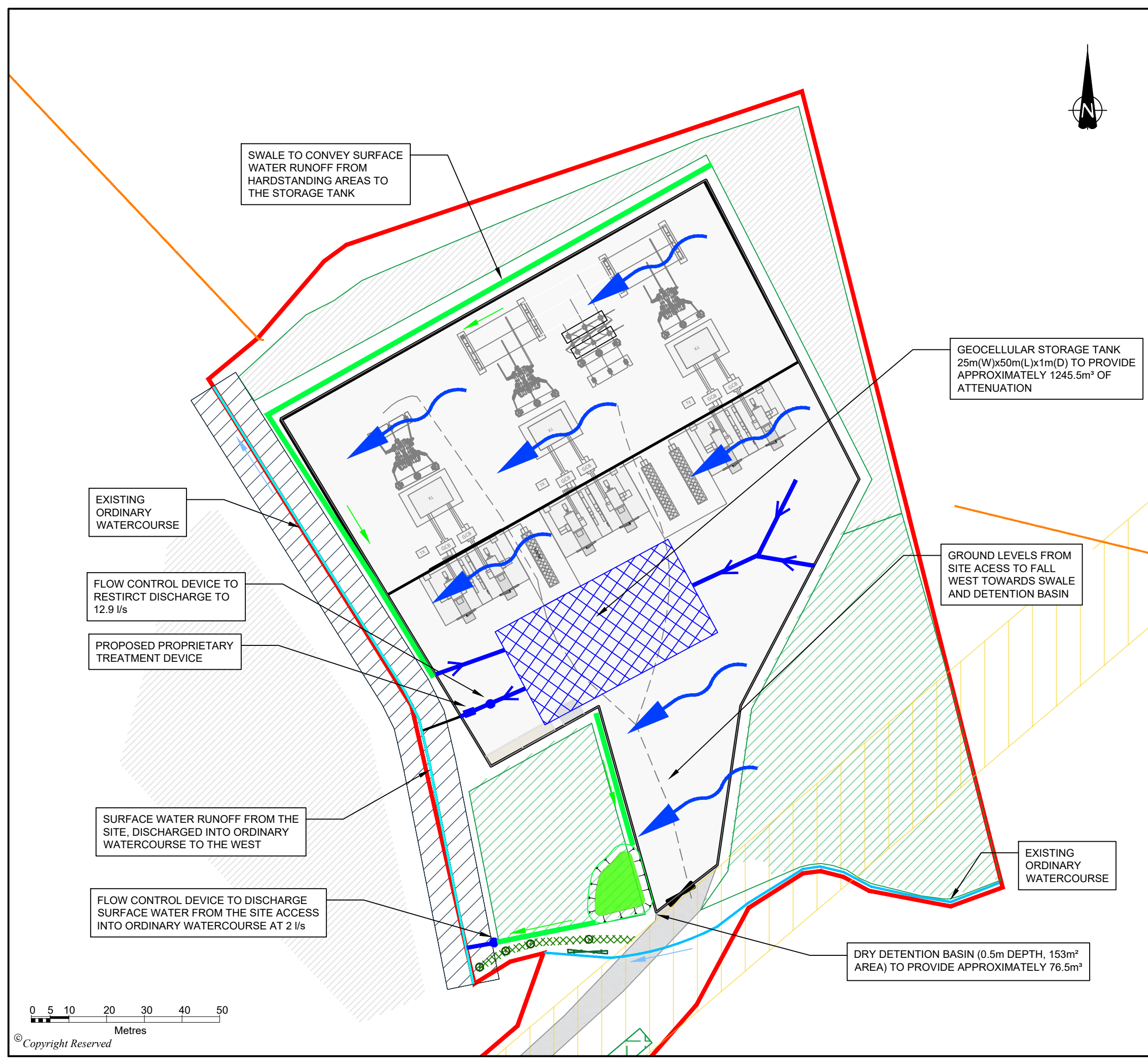

© Copyright Reserved

**STOKE-ON-TRENT**

Sir Henry Doulton House  
Forge Lane  
Etruria  
Stoke-on-Trent  
ST1 5BD  
Tel: +44 (0)1782 276 700

**BIRMINGHAM**

Two Devon Way  
Longbridge Technology Park  
Longbridge  
Birmingham  
B31 2TS  
Tel: +44 (0)121 580 0909

**BOLTON**

41-50 Futura Park  
Aspinall Way  
Middlebrook  
Bolton  
BL6 6SU  
Tel: +44 (0)1204 227 227

**BRISTOL**

Desk Lodge  
2 Redcliffe Way  
Bristol  
BS1 6NL  
Tel: +44 (0)117 203 4477

**BURY ST EDMUNDS**

Armstrong House  
Lamdin Road  
Bury St Edmunds  
Suffolk  
IP32 6NU  
Tel: +44 (0)1284 765 210

**CARDIFF**

Tudor House  
16 Cathedral Road  
Cardiff  
CF11 9LJ  
Tel: +44 (0)292 072 9191

**CARLISLE**

Marconi Road  
Burgh Road Industrial Estate  
Carlisle  
Cumbria  
CA2 7NA  
Tel: +44 (0)1228 550 575

**EDINBURGH**

Great Michael House  
14 Links Place  
Edinburgh  
EH6 7EZ  
Tel: +44 (0)131 555 3311

**GLASGOW**

24 St Vincent Place  
Glasgow  
G1 2EU  
Tel: +44 (0)141 428 4499

**LEEDS**

36 Park Row  
Leeds  
LS1 5JL  
Tel: +44 (0)113 831 5533

**LONDON**

Third Floor  
46 Chancery Lane  
London  
WC2A 1JE  
Tel: +44 (0)207 242 3243

**NEWCASTLE UPON TYNE**

City Quadrant  
11 Waterloo Square  
Newcastle upon Tyne  
NE1 4DP  
Tel: +44 (0)191 232 0943

**TRURO**

Baldhu House  
Wheal Jane Earth Science Park  
Baldhu  
Truro  
TR3 6EH  
Tel: +44 (0)187 256 0738

**International office:**

**ALMATY**

29/6 Satpaev Avenue  
Hyatt Regency Hotel  
Office Tower  
Almaty  
Kazakhstan  
050040  
Tel: +7(727) 334 1310